

RFEL24-500 RF Energy Lab Box User's Guide

1. Introduction

The RFEL24-500 RF energy lab box is a 2.45 GHz, 2-channel, 250 W-per-channel, fully integrated RF development system. The development system can control frequency, phase and power for each channel. The integrated high accuracy measurement system monitors and logs all critical parameters. Fault detection and protection prevent damage to the system.

The RFEL24-500 RF energy lab box uses, as a core, two RFEM24-250 250 W RF energy modules and provides all required support components needed to run the modules, enabling plug-and-play operation.

Key components include:

- Two RFEM24-250 modules
- Cooling system
- Power supply unit
- PC communications interface
- Control software

This user's guide describes safe installation and basic operation of the RFEL24-500 RF energy lab box (RF lab box).

Contents

1. Introduction.....	1
2. Product Description	2
3. Product Certification.....	2
4. Safety	2
5. General Care and Cleaning	5
6. Working Environment.....	5
7. Setup.....	6
8. MHT Interface Software Installation	10
9. Startup.....	13
10. RF Lab Box Operation.....	14
11. Advanced Functions.....	16
12. Troubleshooting and Operating Tips.....	27
13. Revision History	29

2. Product Description

The RFEL24-500 RF energy lab box is a compact 2.45 GHz, 2-channel, 250 W RF source. The RFEL24-500 incorporates a power supply, RF generators and a cooling system in a single unit. Control is through a USB interface to an external Windows® personal computer. It is intended for indoor laboratory use, table mounted or in a rack shelf.

3. Product Certification

NXP guarantees that this product conforms to IEC/EN61010-1, Third Edition, Safety requirements for electrical equipment for measurement, control and laboratory use, Part 1: General requirements.

If you have any problems or questions using the RFEL24-500 or this user's guide, you can send email to RFenergy@nxp.com, including a copy of the diagnostic report, as mentioned in section 11.4, Diagnostics Report. Information is also available on the NXP web at www.nxp.com/RFEL24-500.

4. Safety

4.1. General Safety Summary

Review the following safety precautions carefully before putting the instrument into operation to avoid any personal injury or damage to the instrument and any product connected to it. To prevent potential hazards, use the instrument only as specified by this user's guide.

4.2. Power Cord

Use only the power cord designed for the instrument and authorized for use within your region. The cord must be rated at a minimum of 15 amperes (IEC320).

4.3. Ground

The RF lab box must be grounded through the protective earth (ground) lead of the power cord. To avoid electric shock, it is essential that the power cord be connected to a properly grounded power outlet.

4.4. Shielded RF Loads

Make sure both RF outputs are connected to well-shielded loads before applying power. This is to avoid RF exposure and potential damage to the instrument.

4.5. Overvoltage Protection

Use overvoltage protection (a surge protector) so that no overvoltage (such as that caused by a thunderstorm) can reach the RF lab box. Failure to do so may damage the instrument or expose the operator to electrical shock hazard.

4.6. Covers

Do not operate the instrument with covers or panels removed.

There are no user-serviceable parts inside, so there is no need to remove covers.

Service should be performed by only NXP-authorized personnel.

4.7. Ventilation Holes

To avoid damage to the instrument or electrical shock, do not insert anything into any of the ventilation holes.

4.8. Fuses

Use only the specified type of fuse: 250 V, 15 A, fast-acting Littelfuse 314 or equivalent.

Figure 1 shows the fuse locations.

If a new fuse is required, use only the specified type of fuse, and follow these steps:

1. Turn off the instrument, and remove the power cord.
2. Insert a straight screwdriver into the slot in the fuse holder, and turn it a quarter turn counterclockwise.
3. Take out the old fuse, and replace it with a new one of the specified type, taking care to close the fuse cover properly.

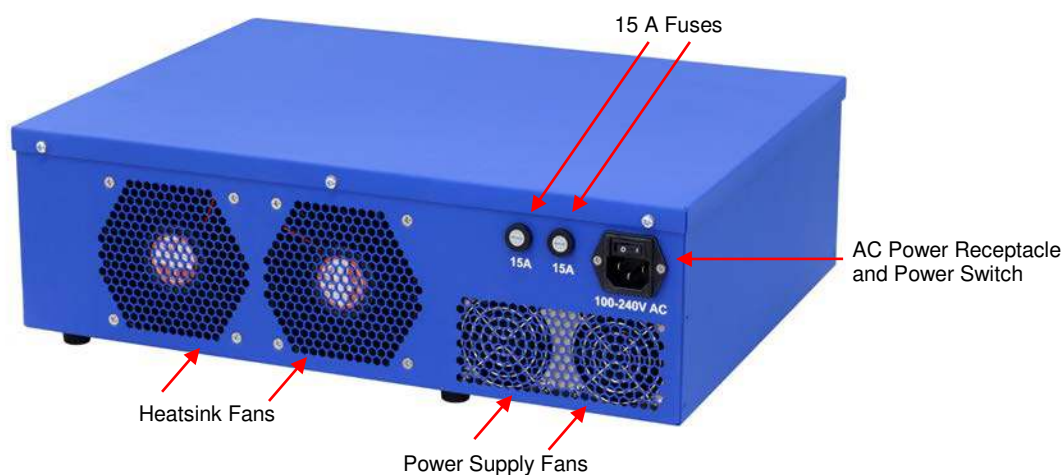

Figure 1. Fan and Fuse Locations

4.9. Suspected Damage

If you suspect damage has occurred to the RF lab box, have it inspected by qualified service personnel before further operation. Any maintenance, adjustment or replacement—especially to internal components—must be performed by NXP-authorized personnel.

4.10. Ventilation

WARNING

Inadequate ventilation will cause high temperature operation and potentially damage the instrument. Therefore, keep the instrument well ventilated, and inspect the intake and fan regularly for dirt and other obstructions.

This instrument uses forced-air cooling. Make sure that the air intake and exhaust areas are free from obstructions and have free airflow. When using the instrument in a benchtop or rack setting, provide at least 10 cm of clearance on each side, above and behind the instrument for adequate ventilation.

4.11. Wet Conditions

To avoid electric shock or damage to the internal circuitry of the instrument, do not operate it under extremely humid or wet conditions.

4.12. Explosive Atmosphere

To avoid personal injury or damage to the instrument, do not operate in or near an explosive atmosphere.

4.13. Surfaces

To avoid contamination by dust or moisture in the air, keep the surface of the instrument clean and dry.

4.14. Electrostatic Discharge Prevention

Operate in an ESD (electrostatic discharge) safe area to avoid damage by static discharge. Always ground the internal and external conductors of cables to remove any static charge before connecting them to the instrument.

5. General Care and Cleaning

Do not store or leave the instrument where it may be exposed to direct sunlight for long periods.

Clean the instrument regularly by performing these steps:

1. Disconnect the instrument from all power sources.
2. Clean the loose dust on the outside of the instrument with a damp, lint-free cloth, using mild detergent or water.
3. Clean the fans and vents with compressed air, taking care not to spin the fans at extremely high speed.

CAUTION

To avoid damage to the instrument, do not use acidic or caustic liquids, which can cause corrosion or damage the finish.

WARNING

To avoid injury resulting from leakage circuit, make sure the instrument is completely dry before reconnecting it to a power source.

6. Working Environment

Location

- Indoor use only
- Tabletop or rack mount

Temperature

- Operating: 0°C to +50°C
- Non-operating: -40°C to +70°C

Humidity

- 0°C to +30°C: ≤ 95% relative humidity
- +30°C to +40°C: ≤ 75% relative humidity
- +40°C to +50°C: ≤ 45% relative humidity

Altitude

- Operating: < 3 km (10,000 ft)
- Non-operating: < 15 km (50,000 ft)

7. Setup

7.1. Hardware and Software Requirements

These items are needed to operate the instrument:

- Suitable test load or cavity with launcher/appliator that can handle 250 W per channel
- Low-loss cables capable of handling 300 W at 2.4 to 2.5 GHz (LMR400 or better)
- PC running Windows 7 or newer 32- or 64-bit operating system, 1 GB free disk space, 1.5 GHz or faster CPU, 500 MB RAM

7.2. Hardware Overview

The RFEL24-500 RF energy lab box is the development system for the RFEM24-250, a fully integrated 2.45 GHz, 250 W RF generator module.



Figure 2. RFEL24-500 RF Energy Lab Box – Front and Rear Views

- RF lab box includes:
 - two RFEM24-250 RF energy modules
 - a cooling system (heatsink, fans)
 - a 30 V, 500 W power supply unit
 - a USB to I²C communications interface

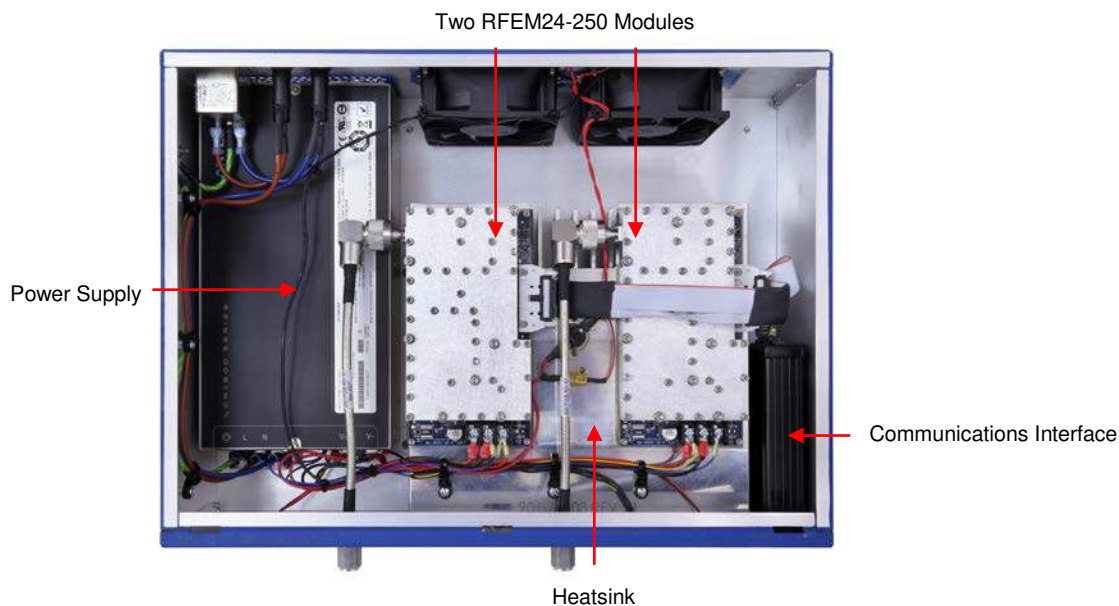

Figure 3. RFEL24-500 RF Energy Lab Box – Internal View

The RFEM24-250 module is a fully integrated 2.45 GHz, 250 W RF generator module that includes full measurement capabilities. Its microcontroller includes an RF source that drives a 3-stage RF amplifier lineup. Its comprehensive command set controls parameters such as frequency, phase and power. The extensive measurement system provides calibrated data from multiple internal sensors and supports closed-loop operations.

- The RF energy module includes:
 - MRF24300N – 300 W final stage transistor
 - MHT1008N – 8 W driver
 - MMA25312B – 31 dBm pre-driver
 - Kinetis[®] KW40Z – MCU with built-in 2.45 GHz RF generator
 - RF power detectors
 - Temperature sensors
 - Current sensor
 - Voltage sensor

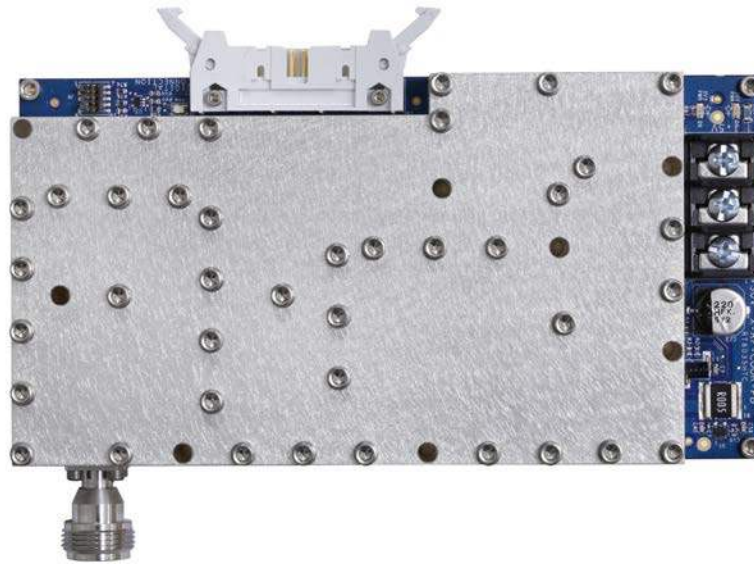

Figure 4. RFEM24-250 RF Energy Module – Top View

7.3. Connections, Controls and Indicators

Figure 5 shows the power switch location above the AC power receptacle.



Figure 5. Power Switch

The unit has six status LEDs. Figure 6 shows the locations of the LEDs.

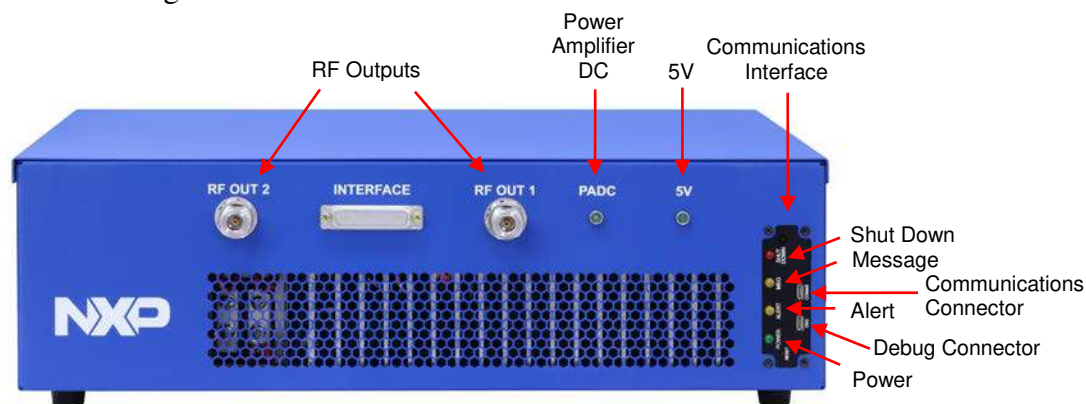

Figure 6. LED System Indicators and Connectors

7.3.1. Description of Connectors and Indicators

- 15 A fuse holder (See section 4.8, Fuses, for detailed description.)
- AC power receptacle and power switch
- Heatsink fans
- Power supply fans
- PADC: this LED indicates that mains-powered 30 V power amplifier DC supply is active.
- 5V: this LED indicates that mains-powered 5 V auxiliary supply is active.
- SHUT DOWN: this LED indicates that hardware shutdown has been asserted.
- MSG: this LED is not used in this instrument.
- ALERT: this LED is not used in this instrument.
- POWER: this LED indicates that the communications interface subsystem is receiving power from the instrument.
- DBG (debug): for factory use only
- COMMS (communications): for USB cable to communicate to PC

In normal operation:

- The 5V and PADC lights are on.
- The Power light is on.

8. MHT Interface Software Installation

This section contains instructions on how to install the MHT Interface software required to operate the RF lab box.

NOTE

MHT Interface software runs on only the Windows operating system (see section 7.1, Hardware and Software Requirements).

To install the MHT Interface software, perform the following steps:

1. From the NXP website (www.nxp.com/RFEL24-500 > Software & Tools), download the latest software installer file: nxp_rfel_setup.msi.
2. Launch the executable setup file to install the software. Note that the nxp_rfel_setup.msi file also contains an electronic copy of the *RFEL24-500 RF Energy Lab Box User's Guide* and the *RF Energy Module Interface Reference Manual*.
3. Click **Next**.

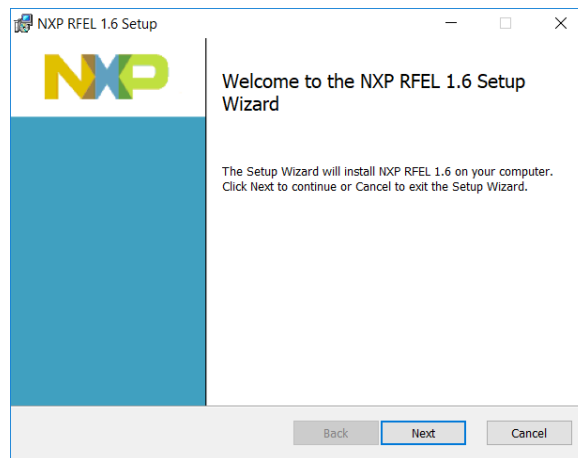

4. Read the terms of the license agreement, select “I accept the terms of the License Agreement” and then click **Next**.

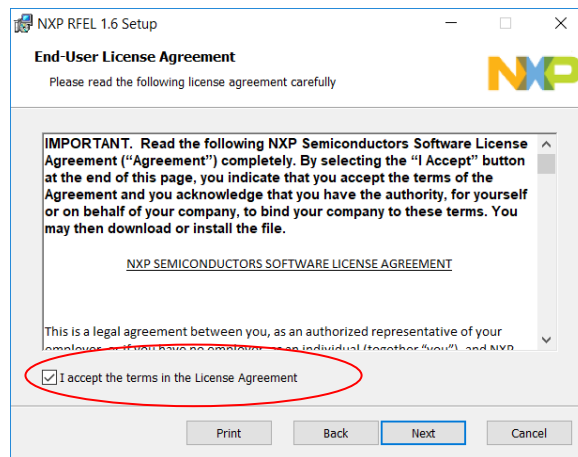

You must accept the terms in the License Agreement to proceed.

- Choose a location to install the software, or accept the default location, and then click **Next**.

Programming Examples and Desktop Shortcuts installations are optional during Custom Setup.

Note that if you have chosen to not include any or some of the optional Programming Examples or Desktop Shortcuts during installation, you can go back at any time to make incremental changes by rerunning the Installer and choosing which additional features you would like to install.

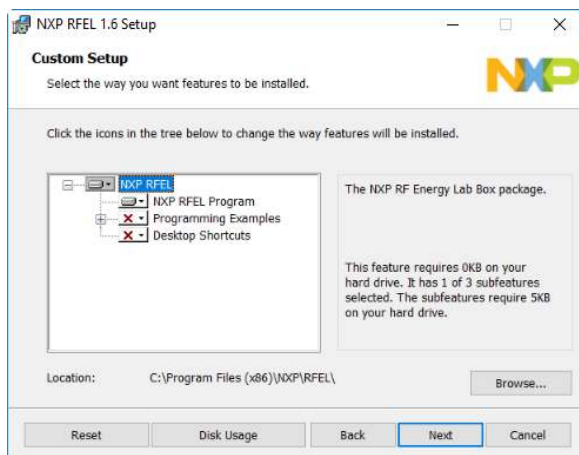

During custom setup you can choose to install programming examples provided for Visual Studio C#, LabVIEW and MATLAB.

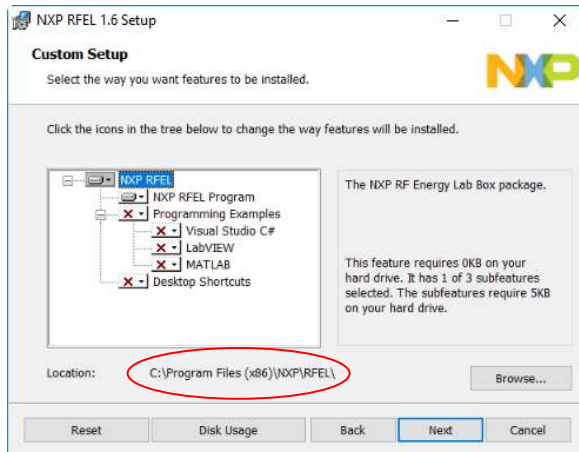

For future use, make note of the file location, which is where examples and help files are located.

6. Click **Install** to start the install procedure.

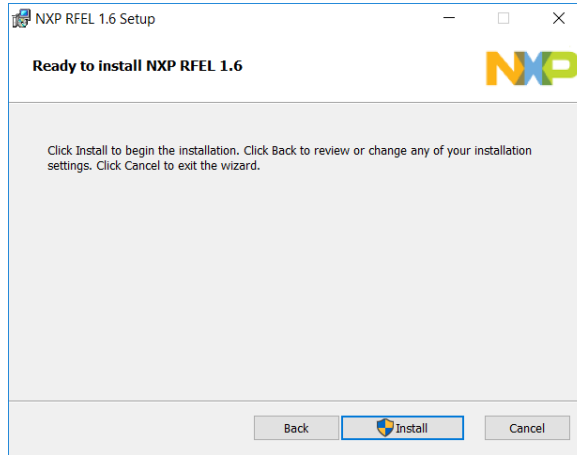

The following figure indicates a process that may take several minutes.

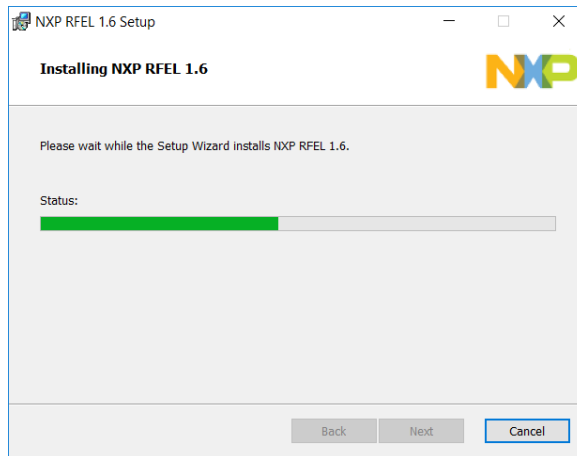

7. The installer asks for device driver installation approval. Click **Install** to install the drivers.

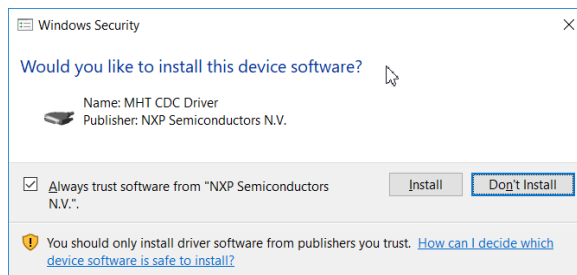

- Click **Finish** to finish the installation process.

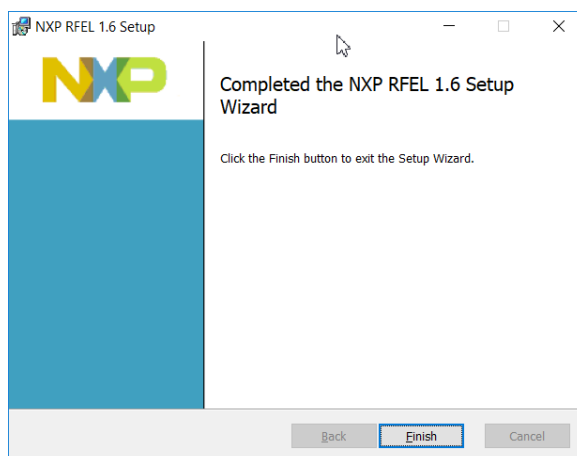

9. Startup

9.1. Turn-on Sequence

- Connect cables.
 - RF cables: Connect the RF lab box to an appropriate load or test fixture. The recommended cable is a one-half inch Heliac type to handle the power and minimize loss to the load.
 - USB: Connect to PC using a standard USB Type-A to Micro USB Type-A cable to the COMM socket on the RFEL communications interface.
 - Mains power cable: Connect to AC power using a 3-wire cable with an IEC 320 plug to the appropriate AC power connector for your location. Make sure that the outlet is a 3-wire grounded type.
- Switch on mains power. The switch is adjacent to the power input connector. Check that the PADC and 5 V indicators are illuminated to verify power supply operation.
- Launch the RFEL software. Refer to section 10, RF Lab Box Operation, for operating information about the RFEL software.

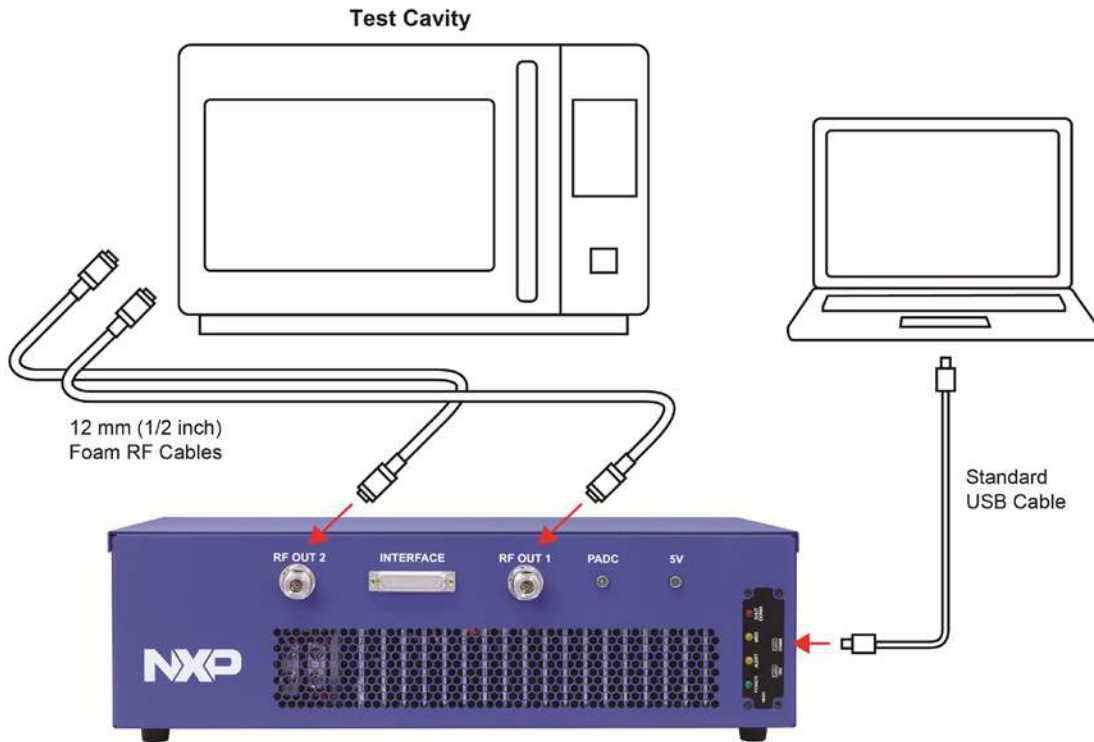
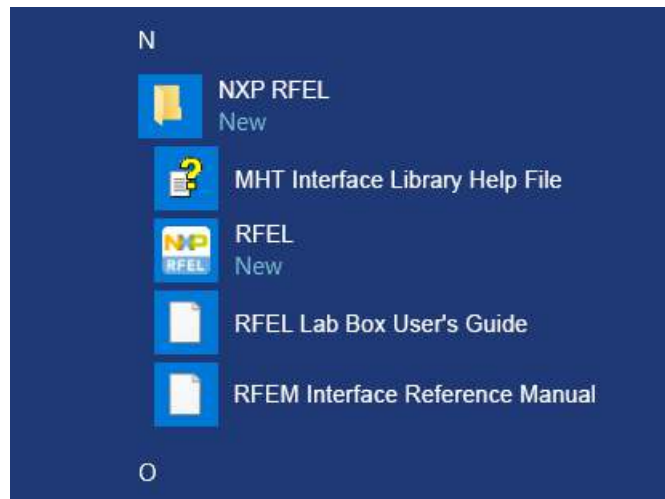

Figure 7. RF Lab Box Typical Application

10. RF Lab Box Operation

Launch the RFEL application. It is found in the NXP folder on the Windows Start menu.



When the RFEL software starts, this display will appear:

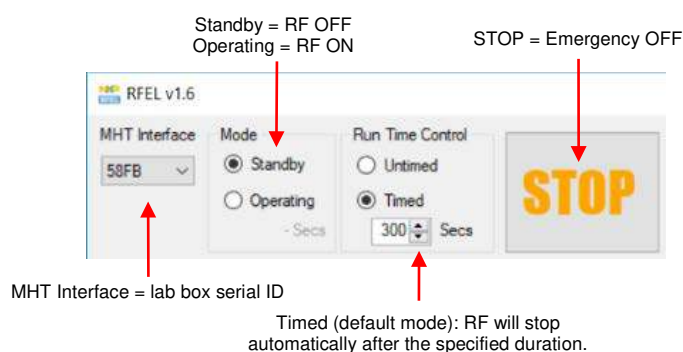
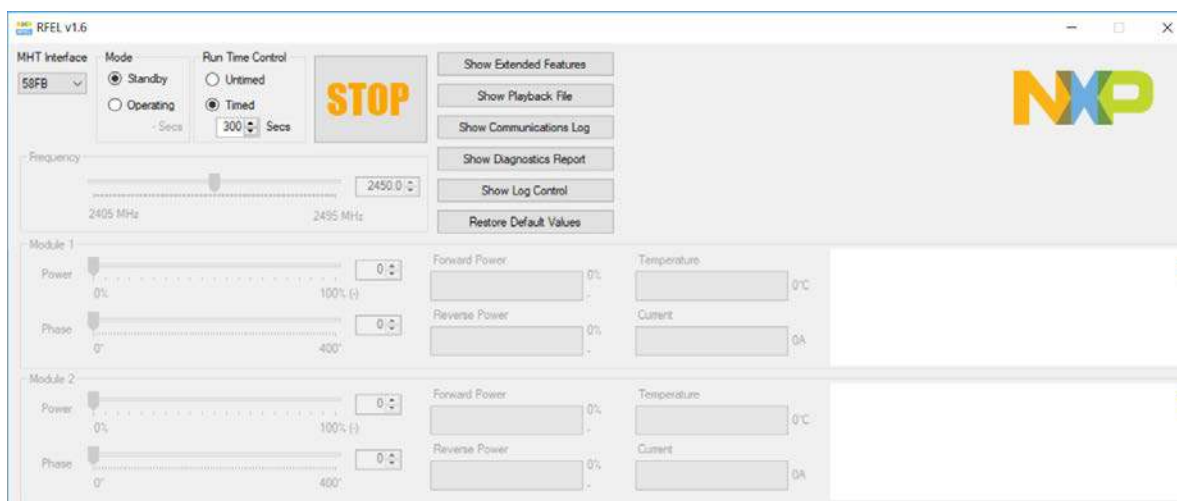

- Turn on the RF by clicking **Operating**.
- The frequency is adjusted for all modules simultaneously, which are phase and frequency synchronized.
- The power and phase can be adjusted for each module independently.
- The output power (Forward Power), reflected power (Reverse Power), the final stage transistor temperature (measured with a temperature sensor close to the transistor) and the module current consumption are dynamically shown by the RFEL software.
- The RF power plot on the right shows the record of forward and reverse power over time.

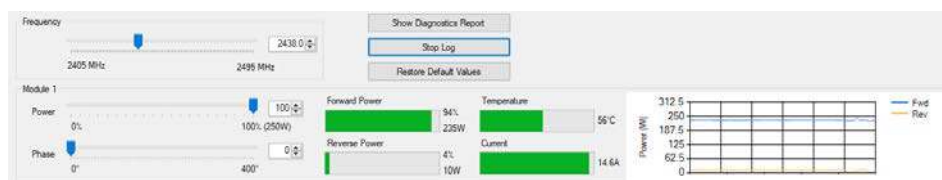

11. Advanced Functions

The advanced functions are accessible through these controls. Details for each function are located in the following sections.

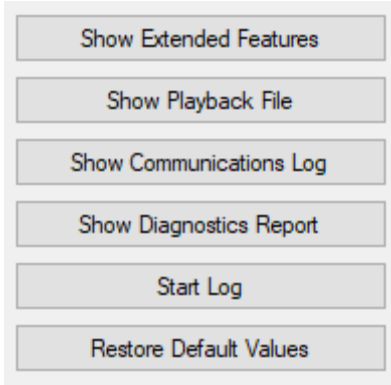

11.1. Extended Features

The extended features enable users to make frequency or phase sweeps to find the points with the best match to the load. After completing at least one sweep, then using the Best mode, the system will hop from one best point to another to maximize the energy transferred to the load.

The best points are ranked by the frequency/phase parameters, enabling the maximum power to be delivered to the load, where maximum power = forward power – reverse power.

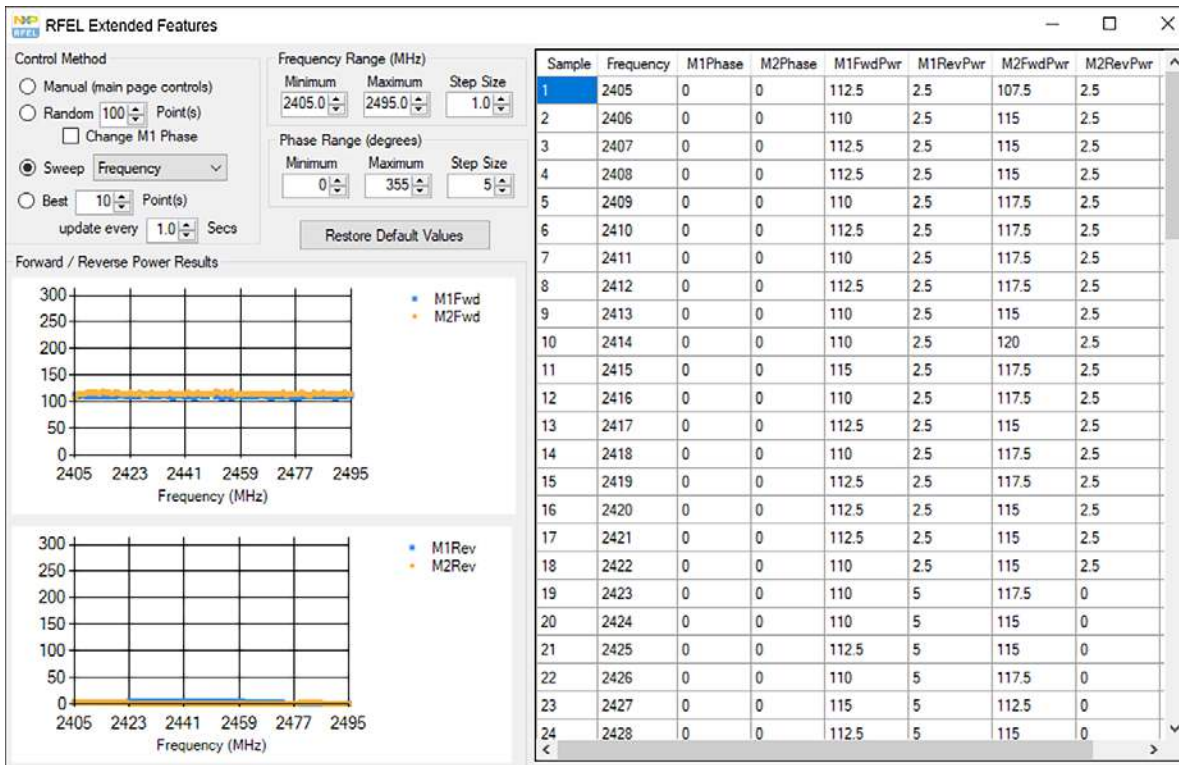

How to find the best points:

1. Switch the RF on using the main window. Specify the RF power level for each module in the main window.
2. Execute a frequency or phase sweep by selecting the Sweep Mode in the Extended Features interface.
 - a) The frequency or phase range as well as step sizes can be specified.

Frequency Range (MHz)

Minimum	Maximum	Step Size
2405.0	2495.0	1.0

Phase Range (degrees)

Minimum	Maximum	Step Size
0	355	5

- b) After a sweep has completed, the number of “best” values desired can be selected.
- c) The key values are indicated in the table on the right. The points with the lowest VSWR are highlighted in yellow. The number of rows highlighted depends on the number of points specified in the Best section on the left.

RFEL Extended Features

Control Method

Manual (main page controls)

Random 100 Point(s)

Change M1 Phase

Sweep Frequency

Best 10 Point(s)

update every 1.0 Secs

Restore Default Values

Sample	Frequency	M1Phase	M2Phase	M1FwdPwr	M1RevPwr	M2FwdPwr	M2RevPwr
1	2405	155	55	127.5	0	95	0
2	2406	155	55	142.5	0	107.5	0
3	2407	155	55	145	0	107.5	0
4	2408	155	55	147.5	0	107.5	0
5	2409	155	55	145	0	105	0
6	2410	155	55	145	0	107.5	0
7	2411	155	55	147.5	0	107.5	0
8	2412	155	55	145	0	107.5	0
9	2413	155	55	145	0	110	0
10	2414	155	55	145	0	110	0
11	2415	155	55	145	0	107.5	0
12	2416	155	55	145	0	107.5	0
13	2417	155	55	147.5	0	107.5	0
14	2418	155	55	145	0	107.5	0
15	2419	155	55	145	0	107.5	0
16	2420	155	55	145	0	107.5	0
17	2421	155	55	145	0	110	0
18	2422	155	55	145	0	105	0
19	2423	155	55	142.5	0	110	0
20	2424	155	55	142.5	0	115	0
21	2425	155	55	145	0	105	0
22	2426	155	55	142.5	0	110	0
23	2427	155	55	145	0	112.5	0
24	2428	155	55	142.5	0	105	0

Forward / Reverse Power Results

Sweep Forward Power

Sweep Reverse Power

3. Alternatively, select the Random mode, where the system will randomly specify the frequency and the phase for each module. By default, the phase of Module 1 (M1) will remain at 0, and only the phase of Module 2 will be randomly changed.

4. Then select the Best mode. The Best mode can be selected only when at least one sweep has completed. By selecting, for instance, “Best 10 Point(s),” the system will hop among the best 10 points (specified by frequency and phase) continuously. The RF will stay at a given frequency and phase for the number of seconds specified on the interface. As an example, if “Best 10 points” is selected with “update every 1.0 secs,” the system will step to the next “best” point each second. The complete set of points will repeat every 10 seconds.

11.2. Playback File (Scripting)

Playback supports a maximum of four RFEM modules. Playback file format:

- Lines starting with ‘//’ or ‘#’ are ignored.
- Other lines are parsed as values separated by a comma (,), semicolon (;), colon (:) or tab. Note that in locales that use a comma as the decimal separator, only the semicolon, colon and tab can be used as value separators.
- Each line with values is expected to have ten values:
 - Time in seconds, at which to apply the values (e.g., 0.1)
 - Frequency in MHz, must be a multiple of 0.5 in the range 2405 to 2495 (e.g., 2451.5)
 - Phase for Module 1 in degrees, must be a multiple of 5 in the range 0 to 400 (e.g., 25)
 - Phase for Module 2 in degrees
 - Phase for Module 3 in degrees
 - Phase for Module 4 in degrees
 - Power for Module 1 in percent of nominal max power, in the range of 0 to 100 (e.g., 75)
 - Power for Module 2 in percent
 - Power for Module 3 in percent
 - Power for Module 4 in percent
- The time value must be monotonically increasing through the playback file, although the time steps do not have to be consistent.

```
// Playback test file

# Time(secs), Freq(MHz), M1 Phase, M2 Phase, M3 Phase, M4 Phase, M1 Power, M2 Power,
M3 Power, M4 Power
1.0; 2410.0; 0; 5; 10; 15; 10; 15; 20; 25
2.5; 2415.5; 20; 25; 30; 35; 50; 50; 50; 50
5.0; 2415.5; 90; 100; 110; 120; 100; 100; 100; 100
```

11.3. Communications Log

The Communications Log shows the commands that are being issued to the RFEM modules in real time. This provides a convenient way to see what commands the GUI is sending to the modules and the data it is receiving back, which may provide a stepping stone toward creating your own controller.

When the Communications Log window is first opened, it appears as shown below:

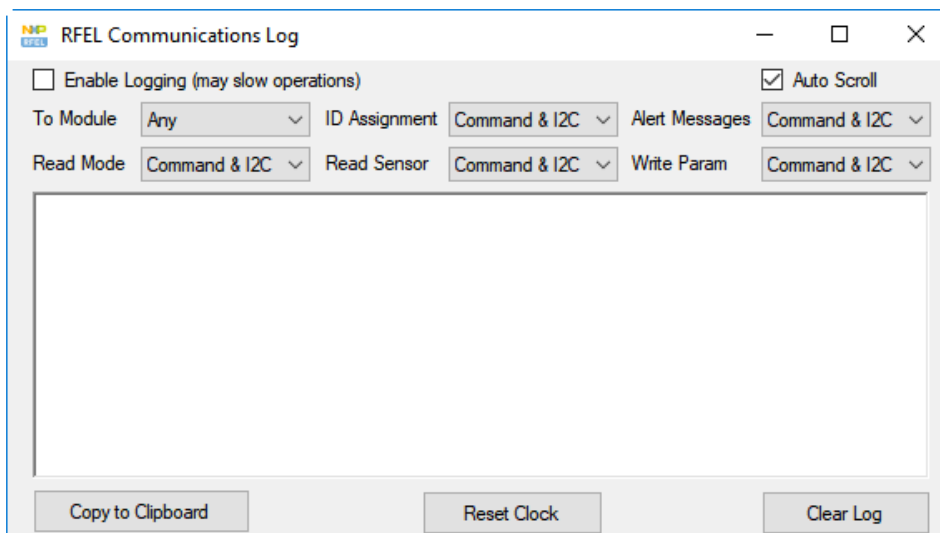

The key parts of the window are:

1. Enable Logging checkbox – When this is checked the communications to the modules will be logged to the window with the applied filters.
2. Auto Scroll checkbox – When this is checked the Communications Log window will automatically scroll vertically so that the most recent transaction is displayed at the bottom of the Communications Log window.
3. Filters – There are six filters that may be used to select which communications transactions are logged to the window:

- a) To Module – Choosing “Any” enables communications to all modules to be logged. Choosing a single module (1, 2, 3, 4) will cause communications to only the selected module to be logged.

Note that choosing “Any” will also include broadcast communications that affect the operation of all modules to be logged. However, if you select an individual module, then only communications specifically directed to that module will be logged. Broadcast communications that also affect the operation of that individual module will not be logged.

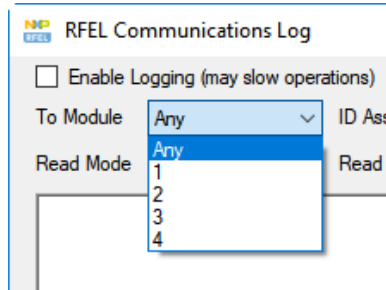

- b) The other five filters choose which types of communication is logged and what level of information is shown. For each of these filters the user can select three levels of logging:

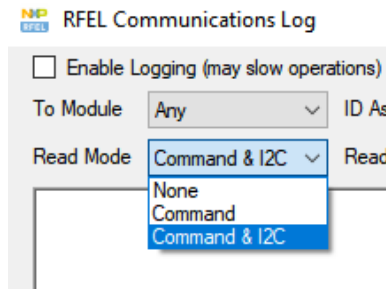

- i. None – No logging of these types of communication occurs.
- ii. Command – Only the high-level description of the command is shown. The high-level description of the command is shown in gray in the Communications Log window and reports which command is being used with its parameters.
- iii. Command and I²C – Both the high-level description of the command and the I²C traffic are shown. The I²C transactions are shown in black. Write transactions are prefixed with “Wr:” and the read transactions are prefixed with “Rd:”. Both of these lines show each byte written and read, with the first byte being the I²C slave address byte.

- c) The five filter areas for types of communication logged are:
- i. ID Assignment – These are the messages exchanged with an RFEM module when it is first connected to the slave bus and powered up. This includes the Alert requesting the ID and the commands to read the Alert register and assign an ID to the module.

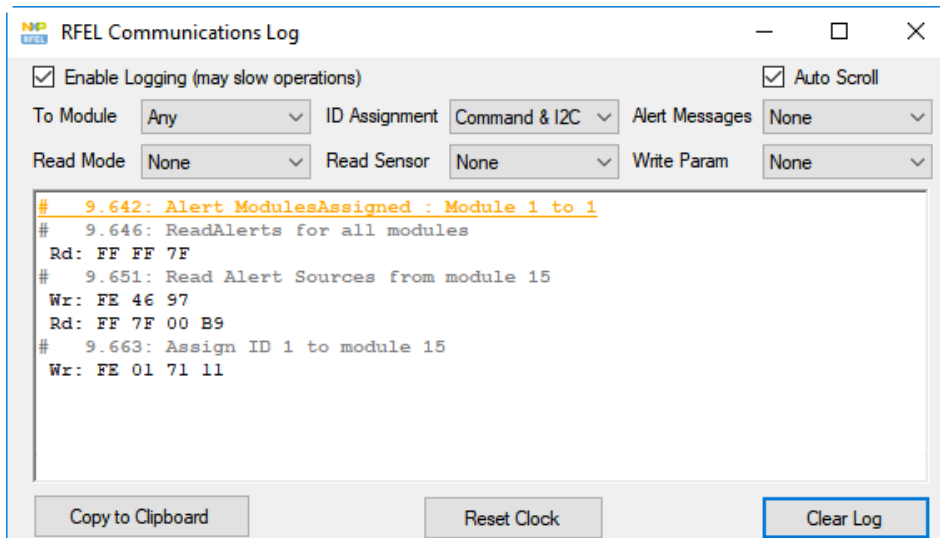

- ii. Alert Messages – These messages are generated by the RFEM module and are signaled by the ALERT_B signal going low. The MHT Interface controller autonomously uses the ReadAlerts command and then reads the Alert Sources from the reporting module to determine the source of the Alert without any interventions from the GUI, so only the digest of the Alert message is shown in the Communications Log, not the actual commands to read the Alerts. You can, however, see these commands used during the ID Assignment.

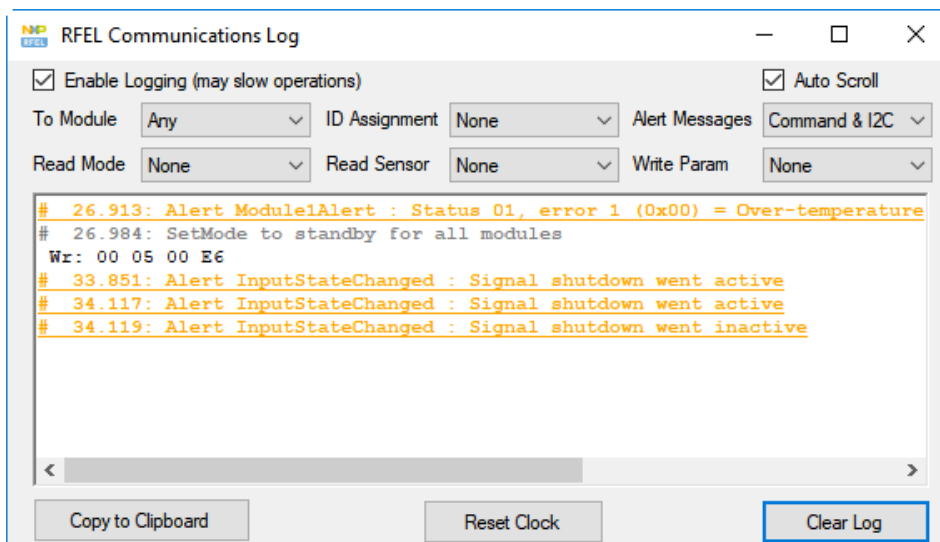

- iii. Read Mode messages – The GUI polls each module continuously during operating mode to ensure that it is in operating state and not in shutdown state. While you may want to use this same strategy, there are many such messages, so disabling their reporting can make it easier to read the Communications Log.

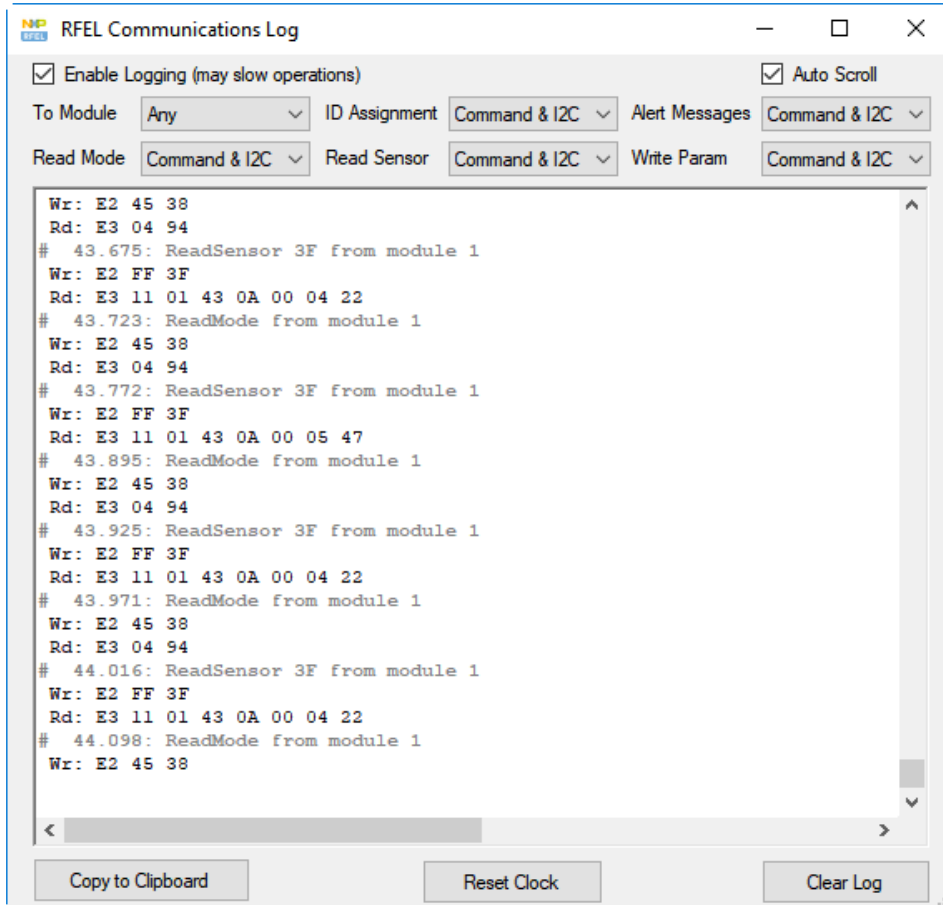

- iv. Read Sensor messages – The GUI polls each module continuously during operating mode to determine the current readings, which are displayed on the GUI. Disabling the reporting of these messages can make the Communications Log easier to read.

- v. Write Param messages – These are sent whenever a parameter (Frequency, Power or Phase) is changed on the GUI. The GUI changes only one parameter at a time, but in your controller you may choose to change multiple parameters at the same time with the same command.

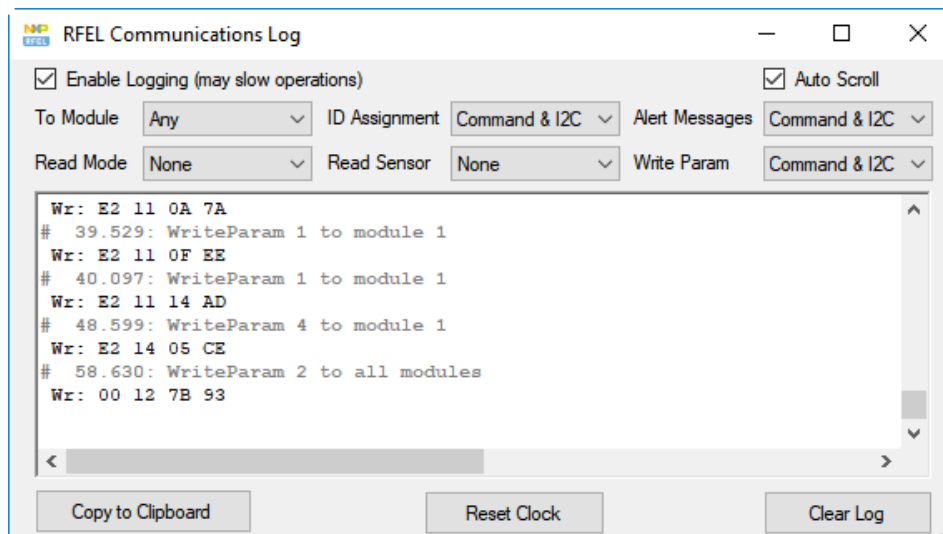

- vi. Some commands (such as Set Mode and ReadInfo) are always logged regardless of the five filter area settings; however, they may still be filtered by the “To Module” filter.
- d) The three buttons along the bottom of the window update the Communications Log window text:
- i. “Copy to Clipboard” copies the entire contents of the Communications Log window to the clipboard so that it can be pasted into another program.
 - ii. “Reset Clock” resets the clock that is reported on the Communications Log lines back to 0.
 - iii. “Clear Log” discards the contents of the Log window.

NOTE

Logging all of the transactions to the Communications Log window can slow down the operation of the GUI, so it is recommended to filter out the commands that you are not concerned with, such as the Read mode and Read Sensor transactions.

Closing the Communications Log window does not stop the logging. If logging was enabled when the window was closed, it will continue logging in the background. If you want to stop logging communications, you must clear the “Enable Logging” checkbox.

11.4. Diagnostics Report

The Diagnostics Report window shows internal parameters that aid NXP support.

Click **Show Diagnostics Report**:

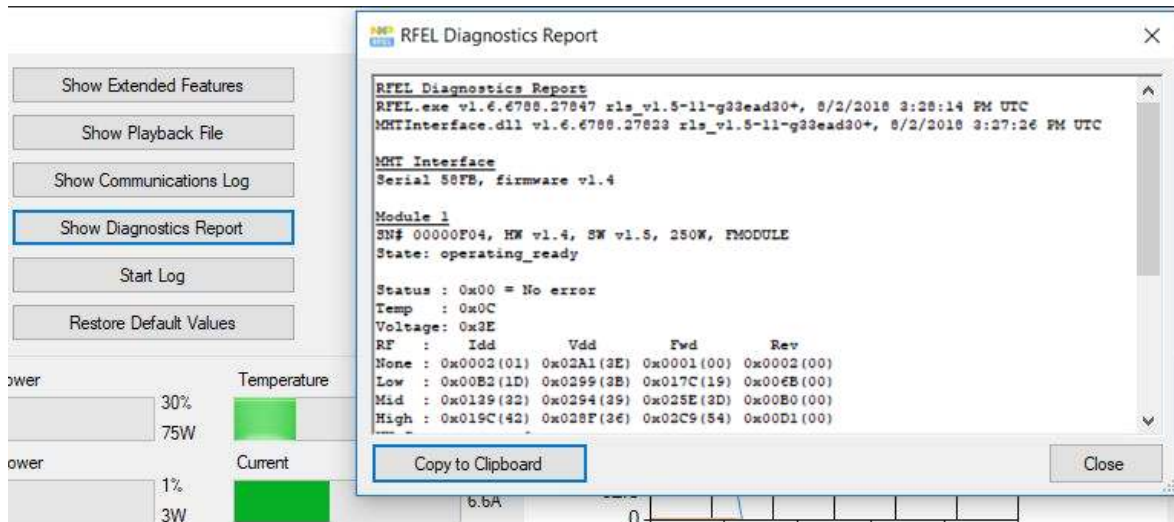

Refer to the sample report. The report includes the version of the GUI software, firmware and the number of communication interface. For each module, as shown in the example, the report shows its serial number, hardware and software version, manufacture and calibration number and the state. If the report shows any error codes, click **Copy to Clipboard** to copy the diagnostics data to the clipboard, which then can be pasted into an email message or another document. The report can be sent to RFenergy@nxp.com. Refer to section 12, Troubleshooting and Operating Tips.

Sample Report:

RFEL Diagnostics Report

RFEL.exe v1.6.6788.27847 rls_v1.5-11-g33ead20+, 8/2/2018 3:26:14 PM UTC
 MHTInterface.dll v1.6.6788.27823 rls_v1.5-11- g33ead20+, 8/2/2018 3:27:26 PM UTC

MHT Interface

Serial 58FB, firmware v1.4

Module 1

SN# 00000F04, HW v1.4, SW v1.5, 250W, FMODULE
 State: operating_ready

Status : 0x00 = No error

Temp : 0x0C

Voltage: 0x3E

RF	Idd	Vdd	Fwd	Rev
None	: 0x0002 (01)	0x02A1 (3E)	0x0001 (00)	0x0002 (00)
Low	: 0x00B2 (1D)	0x0299 (3B)	0x017C (2B)	0x006B (00)
Mid	: 0x0139 (32)	0x0294 (39)	0x025E (4D)	0x00B0 (00)
High	: 0x019C (42)	0x028F (36)	0x02C9 (54)	0x00D1 (00)
HW Comparator : 0				

Module 2

SN# 00000F04, HW v1.4, SW v1.5, 250W, FMODULE
 State: operating_ready

Status : 0x00 = No error

Temp : 0x0A

Voltage: 0x4F

RF	Idd	Vdd	Fwd	Rev
None	: 0x0002 (01)	0x02CB (50)	0x0001 (00)	0x0002 (00)
Low	: 0x00E6 (25)	0x02C8 (4E)	0x01AA (25)	0x0020 (01)
Mid	: 0x0165 (3A)	0x02C5 (4D)	0x0265 (49)	0x0034 (01)
High	: 0x01F3 (50)	0x02C3 (4C)	0x02EE (6B)	0x0041 (02)

11.5. Logging

The logging features can help users record the parameters of the system, such as power, frequency and temperature. When using the “Start Log” function an Excel file is generated and stored in the user’s Documents/RFEL_Log folder, as shown in the following sample.

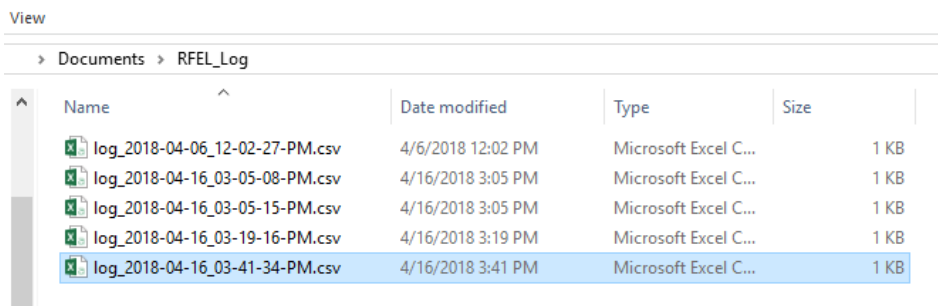

The name of each logging file includes the starting time of the file.

Advanced Functions

To log the data from the RFEL software, click **Start Log**.

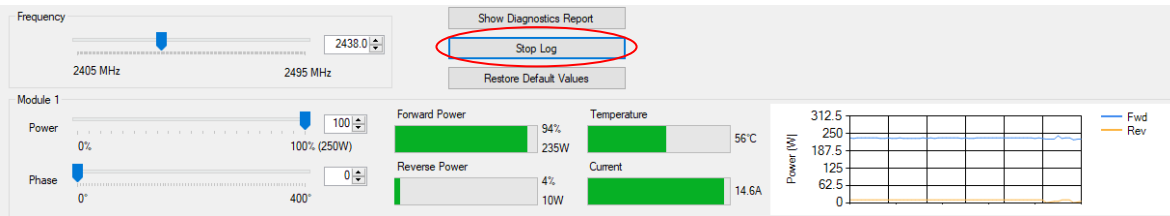

Note that after the **Start Log** button is clicked, logging starts and the **Start Log** button display will change to **Stop Log**. Clicking **Stop Log** stops the logging, saves and closes the current RFEL_Log file, and resets **Stop Log** to **Start Log**.

A sample Log file looks like this in Excel:

time	module	power	phase	frequency	forward	reflected	current	temperati	module	power	phase	frequency	forward	reflected	current	temperature
0.084	1	100	0	2438	93	4	144	56	2	100	90	2438	95	0	150	52
0.194	1	100	0	2438	93	4	144	56	2	100	90	2438	95	0	150	52
0.306	1	100	0	2438	94	4	146	56	2	100	90	2438	95	0	150	52
0.416	1	100	0	2438	93	4	144	56	2	100	90	2438	95	0	150	52
0.523	1	100	0	2438	93	4	144	56	2	100	90	2438	95	0	150	52
0.632	1	100	0	2438	94	4	144	56	2	100	90	2438	95	0	150	52
0.743	1	100	0	2438	93	4	144	54	2	100	90	2438	95	0	150	52
0.852	1	100	0	2438	94	4	144	56	2	100	90	2438	95	0	148	52
0.961	1	100	0	2438	93	4	144	56	2	100	90	2438	95	0	150	52
1.099	1	100	0	2438	94	4	146	56	2	100	90	2438	95	0	148	52
1.292	1	100	0	2438	94	4	144	56	2	100	90	2438	95	0	150	52
1.404	1	100	0	2438	94	4	144	56	2	100	90	2438	95	0	150	52
1.507	1	100	0	2438	94	4	144	56	2	100	90	2438	95	0	150	52
1.618	1	100	0	2438	94	4	146	56	2	100	90	2438	96	0	150	50
1.836	1	100	0	2438	93	4	144	56	2	100	90	2438	95	0	150	52
1.946	1	100	0	2438	94	4	144	56	2	100	90	2438	95	0	148	52
2.056	1	100	0	2438	93	4	144	56	2	100	90	2438	95	0	150	52
2.177	1	100	0	2438	94	4	144	56	2	100	90	2438	95	0	150	52
2.272	1	100	0	2438	94	4	144	56	2	100	90	2438	95	0	150	52
2.382	1	100	0	2438	94	4	144	56	2	100	90	2438	95	0	150	52
2.492	1	100	0	2438	94	4	146	56	2	100	90	2438	95	0	150	52
2.711	1	100	0	2438	94	4	144	56	2	100	90	2438	95	0	150	52
2.931	1	100	0	2438	94	4	144	56	2	100	90	2438	95	0	150	52
3.148	1	100	0	2438	93	4	144	56	2	100	90	2438	95	0	150	52
3.258	1	100	0	2438	94	4	144	56	2	100	90	2438	95	0	150	52
3.477	1	100	0	2438	94	4	144	56	2	100	90	2438	95	0	150	52
3.587	1	100	0	2438	94	4	144	56	2	100	90	2438	95	0	150	52
3.701	1	100	0	2438	93	4	144	56	2	100	90	2438	95	0	148	52
3.805	1	100	0	2438	94	4	144	56	2	100	90	2438	95	0	148	52
3.914	1	100	0	2438	93	4	144	56	2	100	90	2438	95	0	150	52
4.022	1	100	0	2438	93	4	144	56	2	100	90	2438	95	0	150	52
4.132	1	100	0	2438	93	4	144	56	2	100	90	2438	96	0	150	52
4.244	1	100	0	2438	93	4	144	56	2	100	90	2438	95	0	150	52

It includes a time stamp on the first column followed by power, phase, current and frequency for each module.

11.6. Restore Default Values

Restore Default Values will reset all GUI values to factory default values. Log and playback files are not affected.

12. Troubleshooting and Operating Tips

This section contains instructions on how to solve problems that can occur while installing and operating the RFEL24-500 RF energy lab box.

1. When the software installer is being used on the computer for the first time, after it is connected to the communication interface, the computer may reinstall the drivers for the communication interface, which may take up to 2 minutes.
2. If the software installed all the drivers successfully, the system will be recognized. If the system is not recognized, check in Device Manager, as shown below. In this example the NXP MHT Interface, COM21, is recognized, showing that the driver software has successfully been installed.

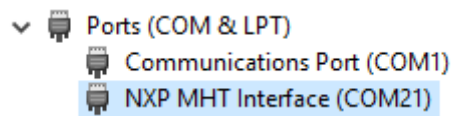

3. If the signal from the communication interface is lost due to cable disconnection or some other reason, such as the PC being shut down, the system will shut down (go to standby state) after 10 seconds to ensure safety.
4. If the cable is disconnected from the RF output port and/or the reverse RF power is greater than the preset limit, the system will shut down (go to standby state). If the RF reverse power is less than the set limit, the system will absorb the power into the circulator termination.
5. If the system heatsink exceeds the preset temperature, the fan will switch to a high-speed setting.
6. If the communications interface indicator turns to yellow or red, try cycling the system power. If the LED on the communications interface is still not green, copy and paste the Diagnostics Report (details in section 11.4, Diagnostics Report), and send the report to RFenergy@nxp.com.
7. In the following figure, the MHT Interface is not found, as shown by the empty “MHT Interface” pull-down menu. Check the power, cabling or installation of the driver software.

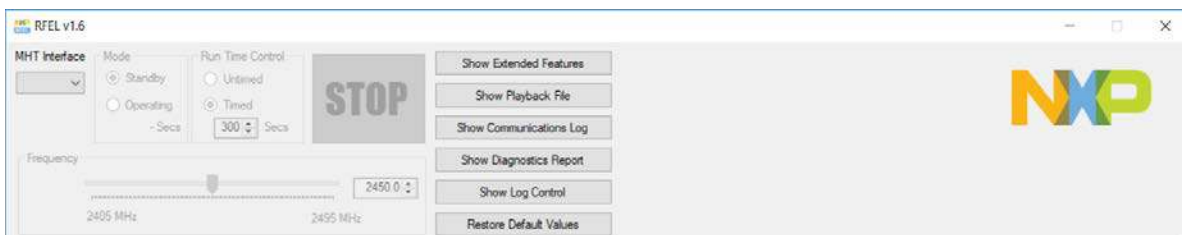

Troubleshooting and Operating Tips

8. In the following figure, only one channel is recognized. This is the normal condition for a single channel system but would indicate a channel failure in a multichannel system.

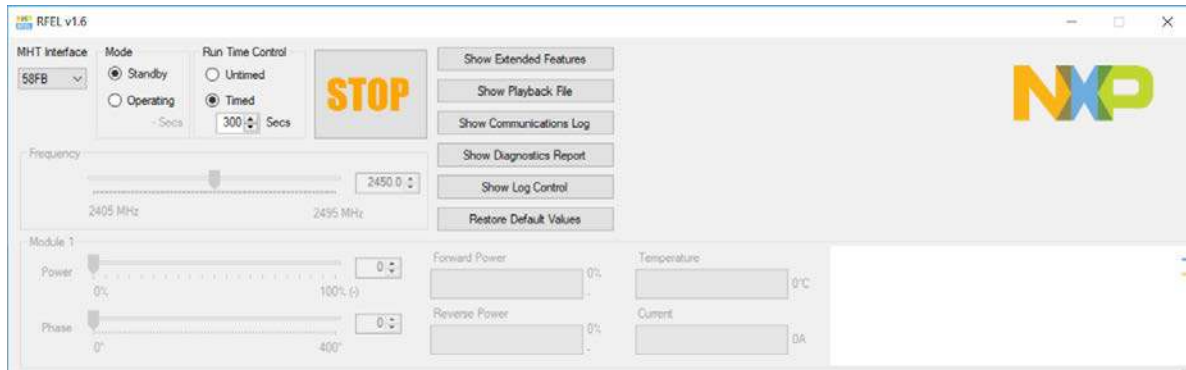

13. Revision History

The following table summarizes revisions to this document.

Revision	Date	Description
0	Oct. 2018	• Initial release of user's guide

How to Reach Us:**Home Page:**

nxp.com

Web Support:

nxp.com/support

Information in this document is provided solely to enable system and software implementers to use NXP products. There are no express or implied copyright licenses granted hereunder to design or fabricate any integrated circuits based on the information in this document. NXP reserves the right to make changes without further notice to any products herein.

NXP makes no warranty, representation, or guarantee regarding the suitability of its products for any particular purpose, nor does NXP assume any liability arising out of the application or use of any product or circuit, and specifically disclaims any and all liability, including without limitation consequential or incidental damages. "Typical" parameters that may be provided in NXP data sheets and/or specifications can and do vary in different applications, and actual performance may vary over time. All operating parameters, including "typicals," must be validated for each customer application by customer's technical experts. NXP does not convey any license under its patent rights nor the rights of others. NXP sells products pursuant to standard terms and conditions of sale, which can be found at the following address: nxp.com/SalesTermsandConditions.

NXP and the NXP logo are trademarks of NXP B.V. All other product or service names are the property of their respective owners.

© 2018 NXP B.V.

