

FEATURES

Passive: no dc bias required
High input IP3: 20 dBm typical
LO to RF isolation: 25 dB typical
LO to IF isolation: 20 dB typical
RF to IF isolation: 15 dB typical
IF frequency range: dc to 4 GHz
Downconverter applications
3 mm × 3 mm, 12-terminal ceramic leadless chip carrier package

APPLICATIONS

Ka band transponders
Point to multipoint radios and very small aperture terminal (VSAT)
Test equipment and sensors
Military end use

GENERAL DESCRIPTION

The HMC1048ALC3B is a general-purpose, monolithic microwave integrated circuit (MMIC), double balanced mixer that can be used as a downconverter with dc to 4 GHz at the intermediate frequency (IF) port and 2.25 GHz to 18 GHz at the radio frequency (RF) port. The mixer requires no external components or matching circuitry.

FUNCTIONAL BLOCK DIAGRAM

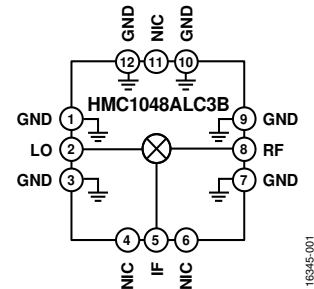

Figure 1.

163345-001

The HMC1048ALC3B provides excellent local oscillator (LO) to RF, LO to IF, and RF to IF isolation. The mixer operates with LO drive levels from 9 dBm to 17 dBm. The HMC1048ALC3B eliminates the need for wire bonding and allows the use of surface-mount manufacturing techniques.

TABLE OF CONTENTS

Features	1	Pin Configuration and Function Descriptions.....	5
Applications.....	1	Interface Schematics	5
Functional Block Diagram	1	Typical Performance Characteristics	6
General Description	1	Downconverter Performance	6
Revision History	2	Isolation and Return Loss	10
Specifications.....	3	Spurious and Harmonics Performance	11
2.25 GHz to 12 GHz Frequency Range.....	3	Theory of Operation	12
12 GHz to 18 GHz Frequency Range.....	3	Applications Information	13
Absolute Maximum Ratings.....	4	Evaluation Board	13
Thermal Resistance	4	Outline Dimensions	15
Solder Profile.....	4	Ordering Guide	15
ESD Caution.....	4		

REVISION HISTORY

5/2019—Rev. A to Rev. B

Change to Table 5	5
-------------------------	---

7/2018—Rev. 0 to Rev. A

Changes to Figure 8 and Figure 9.....	6
Changes to Figure 13, Figure 14, and Figure 15	7
Changes to Figure 17, Figure 18, and Figure 20	8
Changes to Figure 26 Caption, Figure 27, and Figure 28.....	10

2/2018—Revision 0: Initial Version

SPECIFICATIONS

2.25 GHz TO 12 GHz FREQUENCY RANGE

The measurements are performed in downconverter mode at $T_A = 25^\circ\text{C}$, IF frequency (f_{IF}) = 100 MHz, RF signal power = -10 dBm, LO power (P_{LO}) = 13 dBm, and lower sideband with a 50 Ω system, unless otherwise noted.

Table 1.

Parameter	Symbol	Min	Typ	Max	Unit
FREQUENCY RANGE					
RF Frequency	f_{RF}	2.25		12	GHz
IF Frequency	f_{IF}	DC		4	GHz
LO Frequency	f_{LO}	2.25		12	GHz
LO DRIVE LEVEL					
		9	13	17	dBm
RF PERFORMANCE					
Downconverter					
Conversion Loss			10	14	dB
Single Sideband Noise Figure	SSB NF		10		dB
Input Third-Order Intercept	IP3		20		dBm
Input 1 dB Compression Point	P1dB		10		dB
ISOLATION					
RF to IF		8	15		dB
LO to RF		18	25		dB
LO to IF		15	20		dB

12 GHz TO 18 GHz FREQUENCY RANGE

The measurements are performed in downconverter mode at $T_A = 25^\circ\text{C}$, $f_{IF} = 100$ MHz, RF signal power = -10 dBm, $P_{LO} = 13$ dBm, and lower sideband with a 50 Ω system, unless otherwise noted.

Table 2.

Parameter	Symbol	Min	Typ	Max	Unit
FREQUENCY RANGE					
RF Frequency	f_{RF}	12		18	GHz
IF Frequency	f_{IF}	DC		4	GHz
LO Frequency	f_{LO}	12		18	GHz
LO DRIVE LEVEL					
		9	13	17	dBm
RF PERFORMANCE					
Downconverter					
Conversion Loss			10	14	dB
Single Sideband Noise Figure	SSB NF		10		dB
Input Third-Order Intercept	IP3		20		dBm
Input 1 dB Compression Point	P1dB		11		dB
ISOLATION					
RF to IF		6	20		dB
LO to RF		25	30		dB
LO to IF		25	30		dB

ABSOLUTE MAXIMUM RATINGS

Table 3.

Parameter	Rating
RF Input Power when LO = 18 dBm	16 dBm
LO Input Power	20 dBm
IF Input Power when LO = 18 dBm	16 dBm
IF Port Maximum Sink and Source Current	6 mA
Maximum Junction Temperature	175°C
Continuous Power Dissipation, P _{DISS} (T _A = 85°C, Derate 2.6 mW/°C Above 85°C)	235 mW
Operating Temperature Range	-40°C to +85°C
Storage Temperature Range	-65°C to +150°C
Lead Temperature Range	-65°C to +150°C
Reflow Temperature	260°C
Electrostatic Discharge (ESD) Sensitivity	
Human Body Model (HBM)	Class 1B (750 V)
Field Induced Charge Device Model (FICDM)	Class C3 (1.25 kV)

Stresses at or above those listed under Absolute Maximum Ratings may cause permanent damage to the product. This is a stress rating only; functional operation of the product at these or any other conditions above those indicated in the operational section of this specification is not implied. Operation beyond the maximum operating conditions for extended periods may affect product reliability.

THERMAL RESISTANCE

Thermal performance is directly linked to printed circuit board (PCB) design and operating environment. Careful attention to PCB thermal design is required.

θ_{JA} is the natural convection junction to ambient thermal resistance measured in a one-cubic foot sealed enclosure, and θ_{JC} is the junction to case thermal resistance.

Table 4. Thermal Resistance

Package Type	θ_{JA}	θ_{JC}	Unit
E-12-4 ¹	120	383	°C/W

¹ See JEDEC standard JESD51-2 for additional information on optimizing the thermal impedance.

SOLDER PROFILE

The typical Pb-free reflow solder profile shown in Figure 2 is based on JEDEC J-STD-20C.

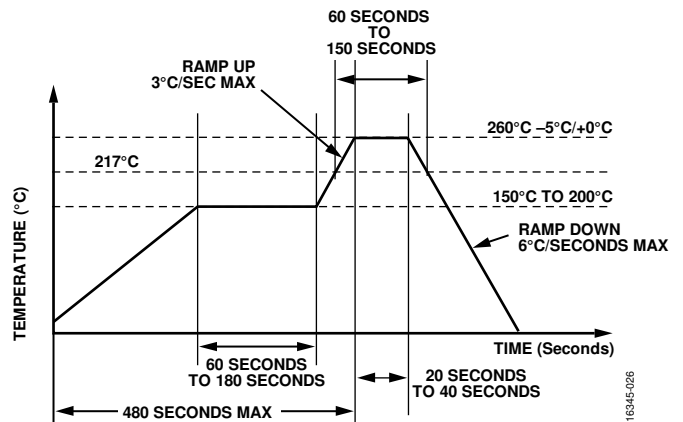

Figure 2. Pb-Free Reflow Solder Profile

ESD CAUTION



ESD (electrostatic discharge) sensitive device. Charged devices and circuit boards can discharge without detection. Although this product features patented or proprietary protection circuitry, damage may occur on devices subjected to high energy ESD. Therefore, proper ESD precautions should be taken to avoid performance degradation or loss of functionality.

PIN CONFIGURATION AND FUNCTION DESCRIPTIONS

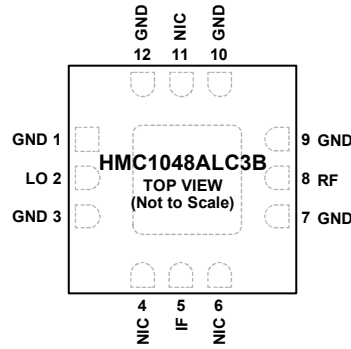

NOTES
 1. NIC = NOT INTERNALLY CONNECTED. THESE PINS CAN BE CONNECTED TO RF AND DC GROUND. PERFORMANCE IS NOT AFFECTED.
 2. EXPOSED PAD MUST BE CONNECTED TO THE RF AND DC GROUND OF THE PCB.

Figure 3. Pin Configuration

Table 5. Pin Function Descriptions

Pin No.	Mnemonic	Description
1, 3, 7, 9, 10, 12	GND	Ground. These pins must be connected to RF and dc ground of the PCB. See Figure 4 for the interface schematic.
2	LO	Local Oscillator Port. This pin is ac-coupled and matched to 50 Ω. See Figure 5 for the interface schematic.
4, 6, 11	NIC	Not Internally Connected. These pins can be connected to RF and dc ground. Performance is not affected.
5	IF	Intermediate Frequency Port. For applications not requiring operation to dc, dc block this port externally using a series capacitor of a value chosen to pass the necessary IF frequency range. For operation to dc, IF must not source or sink more than 6 mA of current. Otherwise, die malfunction and possible die failure can result. See Figure 6 for the interface schematic.
8	RF	Radio Frequency Port. This pin is ac-coupled and matched to 50 Ω. See Figure 7 for the interface schematic.
	EPAD	Exposed Pad. Exposed pad must be connected to the RF and dc ground of the PCB.

INTERFACE SCHEMATICS



Figure 4. GND Interface Schematic

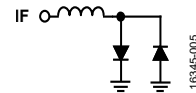

Figure 6. IF Interface Schematic

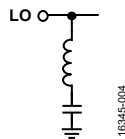

Figure 5. LO Interface Schematic

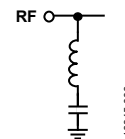

Figure 7. RF Interface Schematic

TYPICAL PERFORMANCE CHARACTERISTICS

DOWNCONVERTER PERFORMANCE

$f_{IF} = 100 \text{ MHz}$, Lower Sideband (High-Side LO)

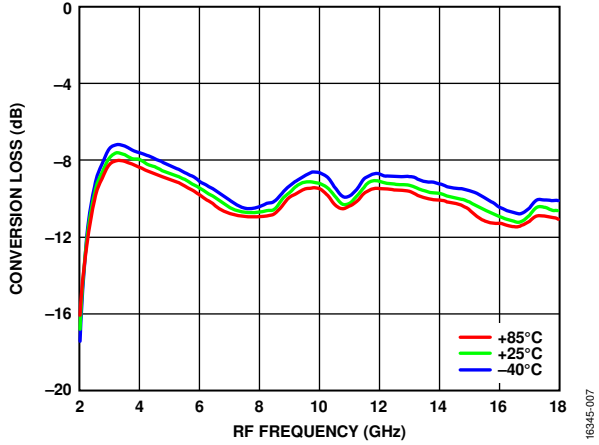

Figure 8. Conversion Loss vs. RF Frequency over Temperature at $f_{IF} = 100 \text{ MHz}$, $P_{LO} = 13 \text{ dBm}$

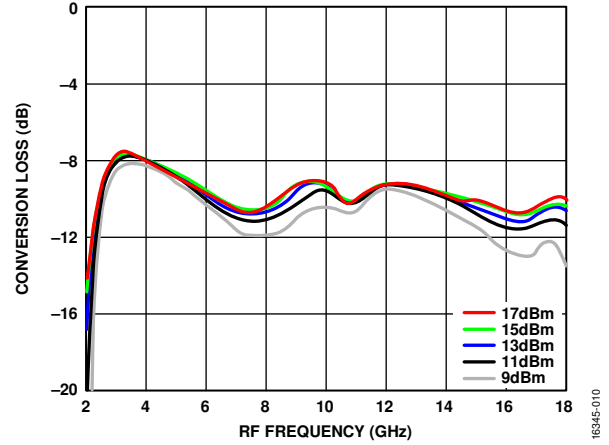

Figure 11. Conversion Loss vs. RF Frequency over LO Drive at $f_{IF} = 100 \text{ MHz}$, $T_A = 25^\circ\text{C}$

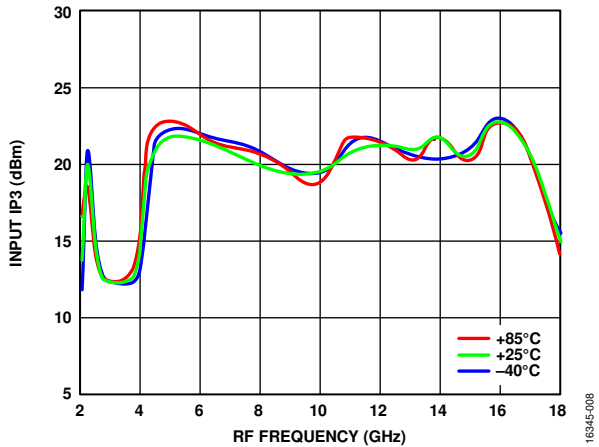

Figure 9. Input IP3 vs. RF Frequency over Temperature at $f_{IF} = 100 \text{ MHz}$, $P_{LO} = 13 \text{ dBm}$

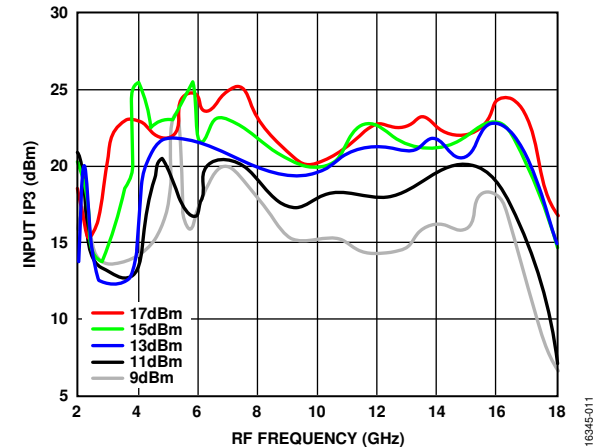

Figure 12. Input IP3 vs. RF Frequency over LO Drive at $f_{IF} = 100 \text{ MHz}$, $T_A = 25^\circ\text{C}$

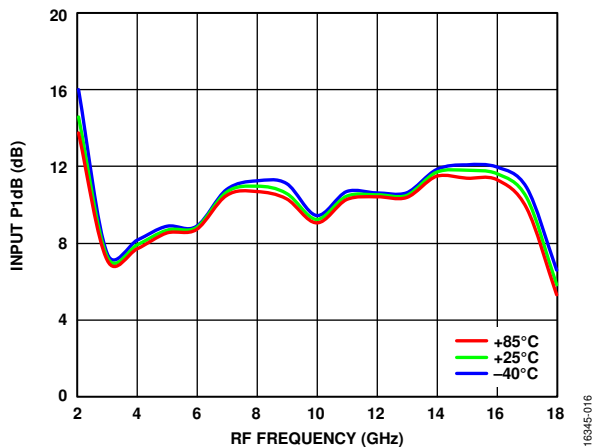

Figure 10. Input P1dB vs. RF Frequency over Temperature at $f_{IF} = 100 \text{ MHz}$, $P_{LO} = 13 \text{ dBm}$

IF = 500 MHz, Lower Sideband (High-Side LO)

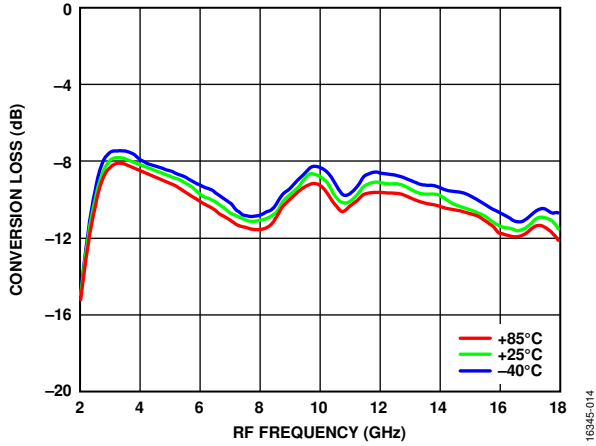

Figure 13. Conversion Loss vs. RF Frequency over Temperature at $f_{IF} = 500$ MHz, $P_{LO} = 13$ dBm

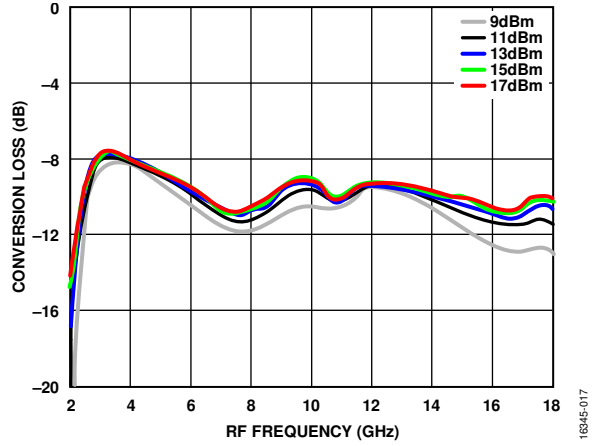

Figure 15. Conversion Loss vs. RF Frequency over LO Drive at $f_{IF} = 500$ MHz, $T_A = 25^\circ\text{C}$

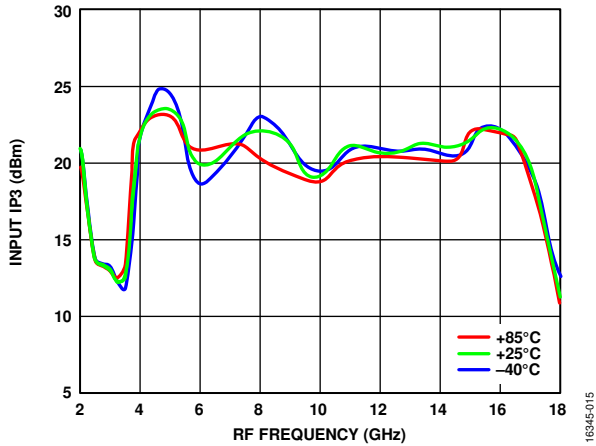

Figure 14. Input IP3 vs. RF Frequency over Temperature at $f_{IF} = 500$ MHz, $P_{LO} = 13$ dBm

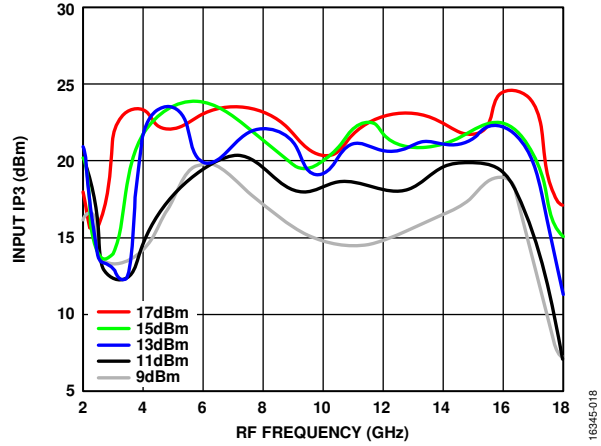

Figure 16. Input IP3 vs. RF Frequency over LO Drive at $f_{IF} = 500$ MHz, $T_A = 25^\circ\text{C}$

IF = 1500 MHz, Lower Sideband (High-Side LO)

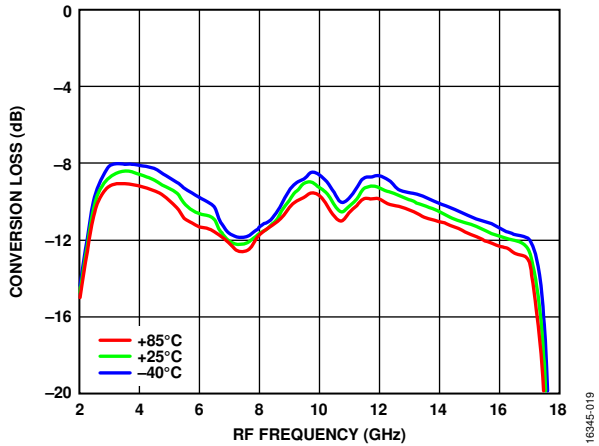

Figure 17. Conversion Loss vs. RF Frequency over Temperature at $f_{IF} = 1500$ MHz, $P_{LO} = 13$ dBm

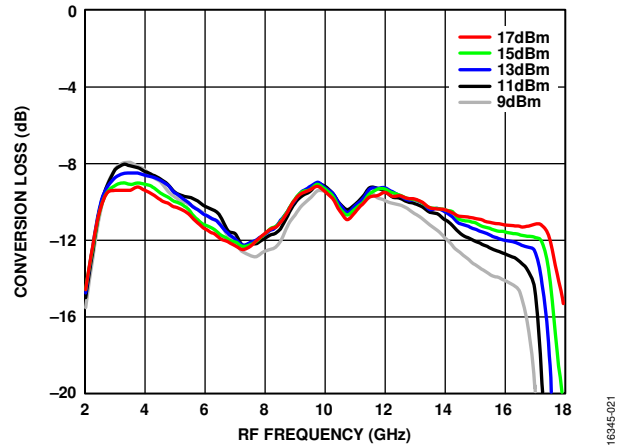

Figure 20. Conversion Loss vs. RF Frequency over LO Drive at $f_{IF} = 1500$ MHz, $T_A = 25^\circ\text{C}$

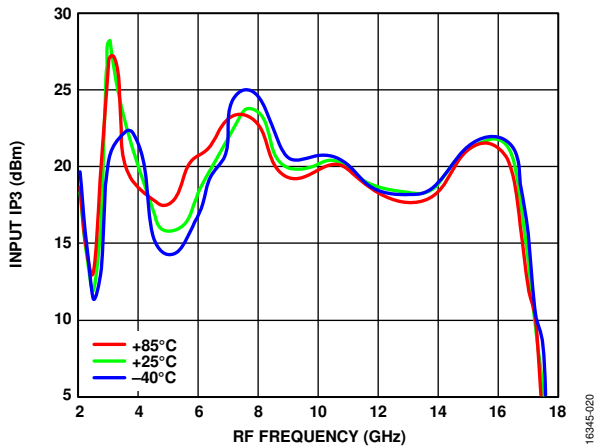

Figure 18. Input IP3 vs. RF Frequency over Temperature at $f_{IF} = 1500$ MHz, $P_{LO} = 13$ dBm

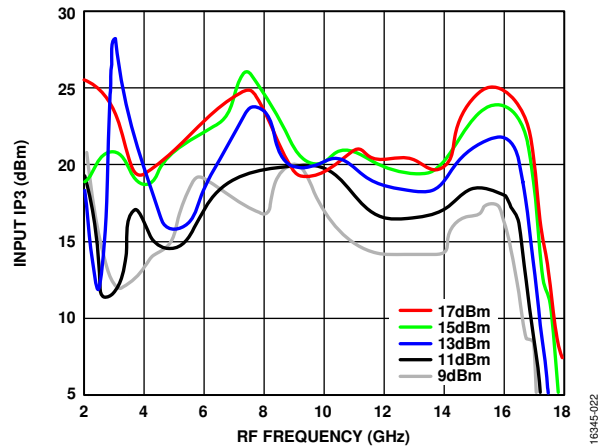

Figure 21. Input IP3 vs. RF Frequency over LO Drive at $f_{IF} = 1500$ MHz, $T_A = 25^\circ\text{C}$

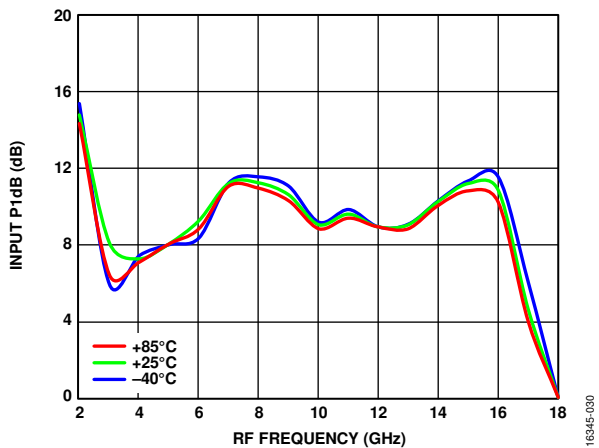

Figure 19. Input P1dB vs. RF Frequency over Temperature at $f_{IF} = 1500$ MHz, $P_{LO} = 13$ dBm

IF Bandwidth

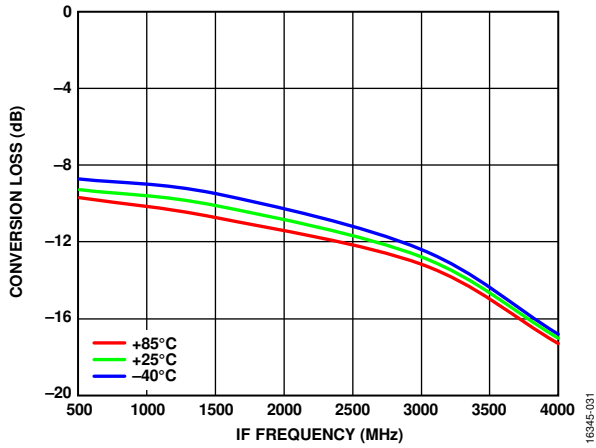

Figure 22. Conversion Loss vs. IF Frequency over Temperature at $f_{LO} = 12$ GHz, $P_{LO} = 13$ dBm

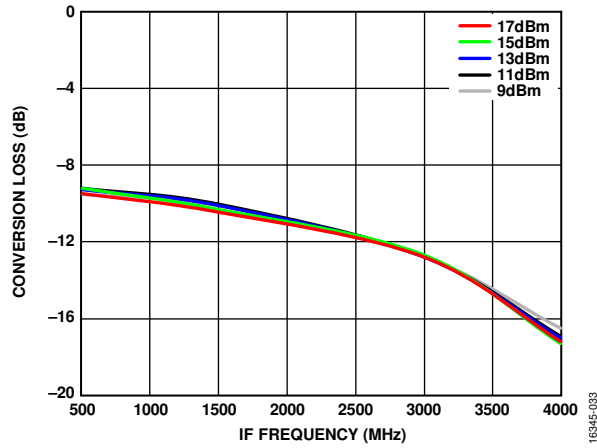

Figure 24. Conversion Loss vs. IF Frequency over LO Drive at $f_{LO} = 12$ GHz, $T_A = 25^\circ\text{C}$

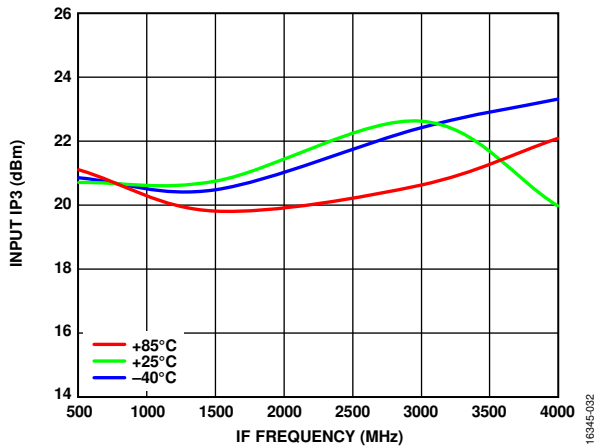

Figure 23. Input IP3 vs. IF Frequency over Temperature at $f_{LO} = 12$ GHz, $P_{LO} = 13$ dBm

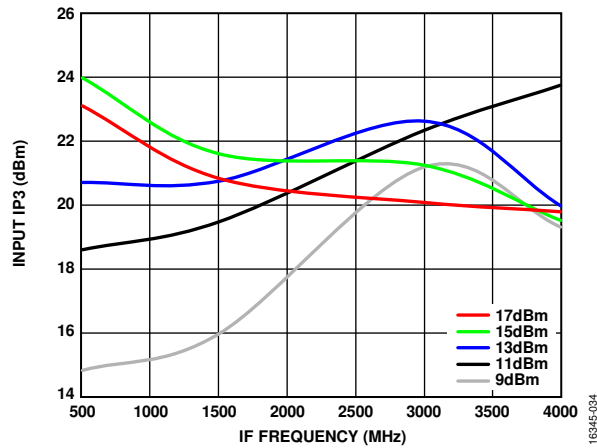

Figure 25. Input IP3 vs. IF Frequency over LO Drive at $f_{LO} = 12$ GHz, $T_A = 25^\circ\text{C}$

ISOLATION AND RETURN LOSS

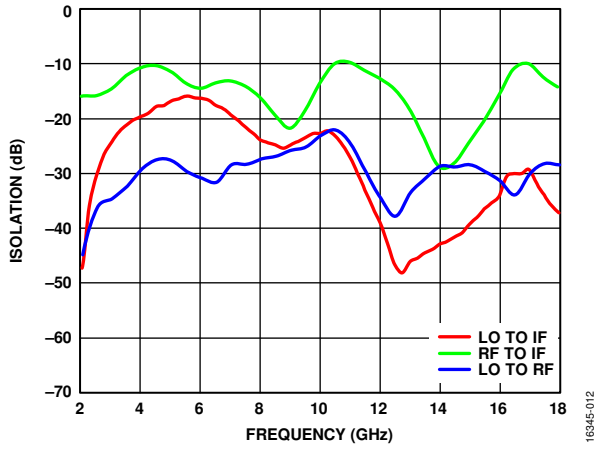

Figure 26. Isolation vs. Frequency, $T_A = 25^\circ\text{C}$

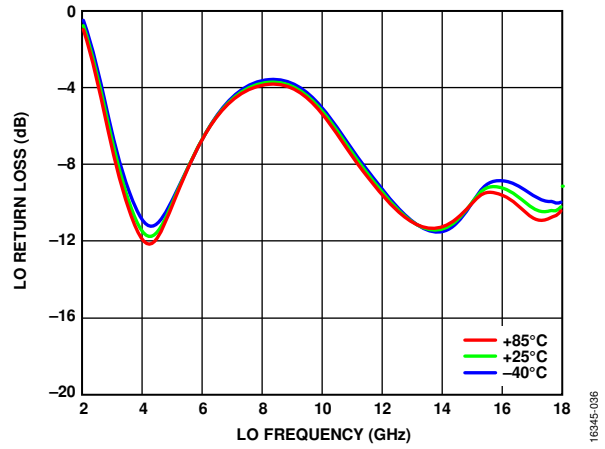

Figure 28. LO Return Loss vs. LO Frequency over Temperature at $P_{LO} = 13\text{ dBm}$

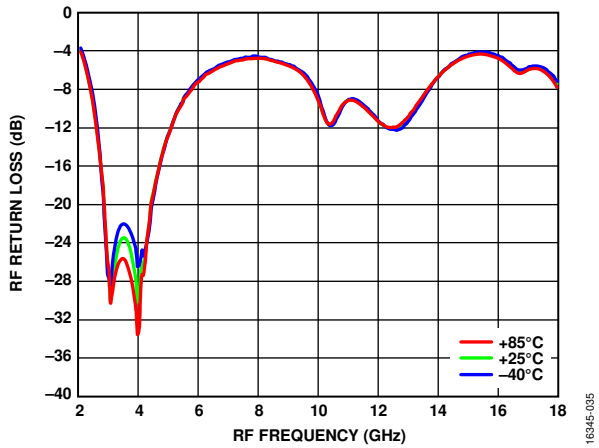

Figure 27. RF Return Loss vs. RF Frequency over Temperature at $f_{LO} = 5.5\text{ GHz}$, $P_{LO} = 13\text{ dBm}$

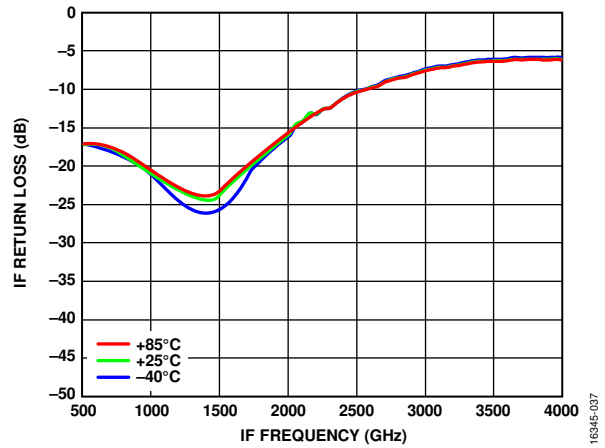

Figure 29. IF Return Loss vs. IF Frequency over Temperature at $f_{LO} = 5.5\text{ GHz}$, $P_{LO} = 13\text{ dBm}$

SPURIOUS AND HARMONICS PERFORMANCE***M × N Spurious Outputs as Downconverter***

When measuring these parameters, -10 dBm RF input power at 4 GHz and 13 dBm LO input power at 4.1 GHz were applied. All values in dBc below the IF output power level and valid for lower sideband measurements. N/A means not applicable.

Spur values are $(M \times RF) - (N \times LO)$.

		N × LO				
		0	1	2	3	4
M × RF	0	N/A	31	19	27	4
	1	4	0	27	35	39
	2	52	34	40	34	59
	3	74	68	57	55	59
	4	77	78	77	62	67

LO Harmonics

When measuring these parameters, 13 dBm LO input power was applied at various LO frequencies. All values in dBc below LO power level are measured at RF port. N/A means not applicable.

Table 6. LO Harmonics

LO Frequency (GHz)	N × LO Spur at RF Port			
	1	2	3	4
2	58	62	57	62
4	34	31	46	40
6	35	30	47	63
10	27	27	39	66
12	47	42	40	65
14	32	55	39	N/A

THEORY OF OPERATION

The HMC1048ALC3B is a general-purpose, double balanced mixer that can be used as a downconverter from 2.25 GHz to 18 GHz.

The HMC1048ALC3B downconverts radio frequencies between 2.25 GHz and 18 GHz to intermediate frequencies between dc and 4 GHz.

APPLICATIONS INFORMATION

EVALUATION BOARD

Figure 30 and Figure 31 show the top and cross sectional views of the EV1HMC1048ALC3B evaluation board, which uses 4-layer construction with a copper thickness of 0.5 oz (0.7 mil) and dielectric materials between each copper layer.

All RF traces are routed on Layer 1, and all other remaining layers are grounded planes that provide a solid ground for RF transmission lines. The top dielectric material is Rogers 4350, offering low loss performance. The prepreg material in the middle is used to attach the core layers together, the RoHS compliant Isola 370HR and the Rogers 4350 layers, with copper traces above and below the prepreg material. Both the prepreg and the Isola 370HR core layer are used to achieve the required board finish thickness.

The RF transmission lines were designed using a coplanar waveguide (CPWG) model with a width of 18 mil and ground spacing of 13 mil for a characteristic impedance of 50 Ω. For optimal RF and thermal grounding, as many plated through vias as possible are arranged around the transmission lines and under the exposed pad of the package.

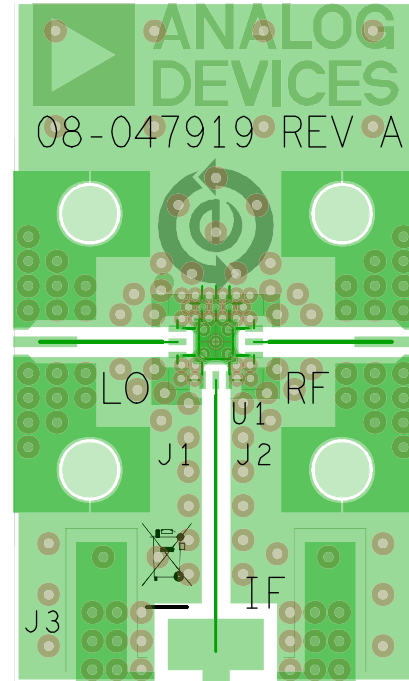

Figure 30. EV1HMC1048ALC3B Evaluation Board Layout Top View

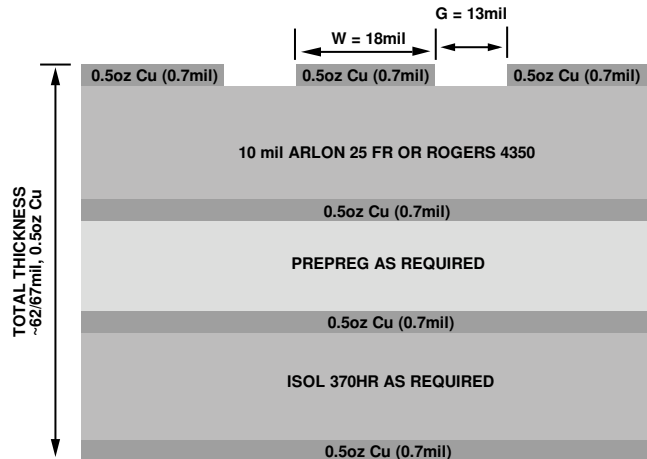

Figure 31. EV1HMC1048ALC3B Evaluation Board Cross Sectional View

Figure 32 shows the [EV1HMC1048ALC3B](#) evaluation board with component placement. Because the HMC1048ALC3B is a passive device, there is no requirement for external components. The LO and RF pins are internally ac-coupled. The IF pin is internally dc-coupled. Use an external series capacitor when IF operation is not required. Choose a value that stays within the necessary IF frequency range (dc to 4 GHz). When IF operation to dc is required, do not exceed the IF source and sink current rating, as specified in the Absolute Maximum Ratings section. The evaluation board shown in Figure 32 is available for order from the Analog Devices, Inc., website at www.analog.com/EVAL-HMC1048A.

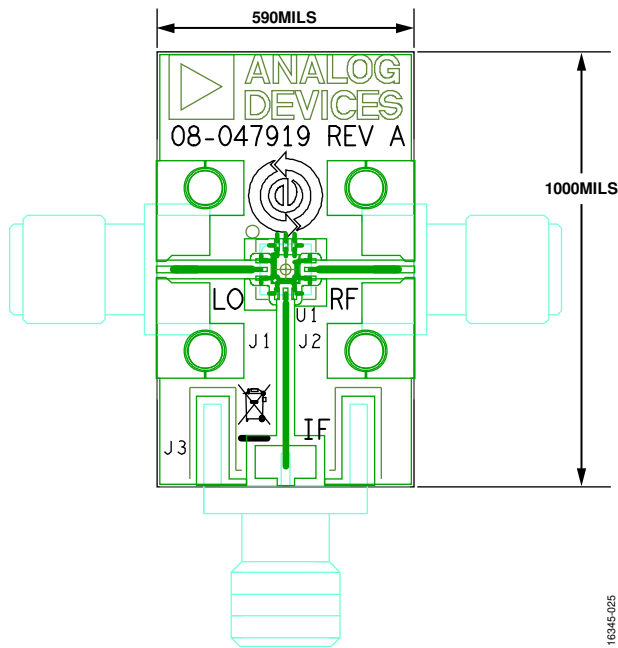

Figure 32. [EV1HMC1048ALC3B](#) Evaluation Board

Table 7 and Figure 33 show the evaluation board schematic and bill of materials, respectively.

Table 7. Bill of Materials for the [EV1HMC1048ALC3B](#) Evaluation Board

Item	Description
J1 to J2	2.92 mm connectors
J3	Subminiature Version A (SMA) connector
U1	HMC1048ALC3B
PCB ¹	08-047919 Evaluation PCB

¹ 08-047919 is the raw bare PCB identifier. Reference the [EV1HMC1048ALC3B](#) part number when ordering the complete evaluation PCB.

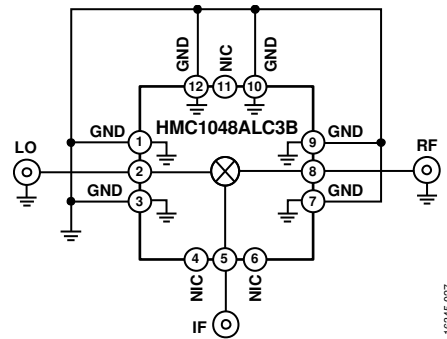

Figure 33. [EV1HMC1048ALC3B](#) Evaluation Board Schematic

OUTLINE DIMENSIONS

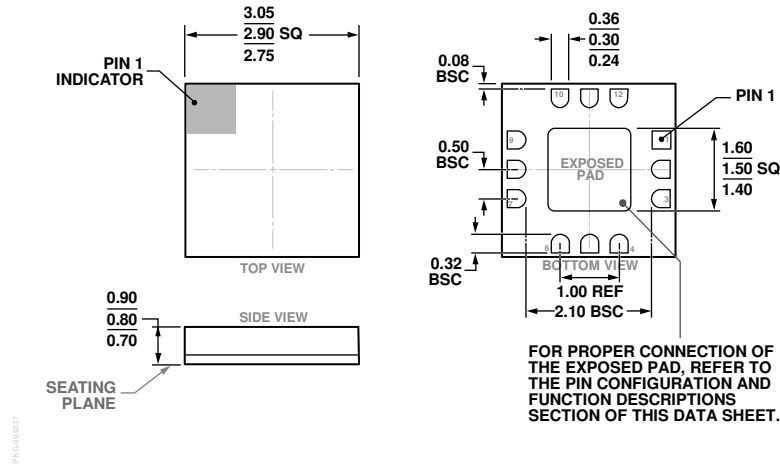

Figure 34. 12-Terminal Ceramic Leadless Chip Carrier [LCC] (E-12-4)
Dimensions shown in millimeters

ORDERING GUIDE

Model ¹	Temperature Range	Moisture Sensitivity Level (MSL) Rating ²	Package Description	Package Option
HMC1048ALC3B	-40°C to +85°C	MSL3	12-Terminal Ceramic LCC	E-12-4
HMC1048ALC3BTR	-40°C to +85°C	MSL3	12-Terminal Ceramic LCC	E-12-4
HMC1048ALC3BTR-R5	-40°C to +85°C	MSL3	12-Terminal Ceramic LCC	E-12-4
EV1HMC1048ALC3B				

¹ All models are RoHS compliant parts.

² See the Absolute Maximum Ratings section, Table 3, and Figure 2 for the peak reflow temperature.