

# Suspended Substrate Stripline Filters and Multiplexers

50Ω DC to 26 GHz

## The Big Deal

- Low insertion loss
- Ultra-wide passband width
- Fast roll-off with wide stopband
- Good power handling and temperature stability
- Passband up to 26 GHz
- Stopband up to 26.5 GHz can extend to 40 GHz



## Product Overview

Mini-Circuits' Suspended Substrate Stripline filters offer low insertion loss by implementing printed circuit board suspended between two parallel ground planes, providing high Q. Low insertion loss combined with wide stopband makes them an excellent choice for wideband instruments and systems like ECM, ECCM, ELINT and ultra-broadband receivers.

Low pass, high pass, band pass, band stop, diplexer and multiplexer designs can be realized with this technology. Advanced filter design and construction can achieve stopband width greater than 6x the center frequency, and temperature stability will be better than other printed circuit realizations because the fields are mainly in the air rather than in a dielectric. The inside walls of the housing hold the circuit and prevent movement that could be caused by vibration or mechanical shock, making these designs excellent candidates for harsh operating environments.

Suspended substrate stripline filters can be realized in small form factors with high-quality, precise machining for applications where size is critical. Excellent repeatability across units is achieved through precise tuning and process control.

## Key Features

Feature	Advantages
Low insertion loss	Low signal loss results in better SNR in receiver front end and better power delivery to antenna in transmitters
Fast roll-off	Higher selectivity results in better adjacent channel rejection and dynamic range
Wide stopband	Wide, spur-free stop band results in better receiver sensitivity
High power handling	Well suited for transmitter applications
Excellent temperature stability	Ensures minimal variation in electrical performance across temperature

### Notes

- A. Performance and quality attributes and conditions not expressly stated in this specification document are intended to be excluded and do not form a part of this specification document.  
B. Electrical specifications and performance data contained in this specification document are based on Mini-Circuit's applicable established test performance criteria and measurement instructions.  
C. The parts covered by this specification document are subject to Mini-Circuits standard limited warranty and terms and conditions (collectively, "Standard Terms"); Purchasers of this part are entitled to the rights and benefits contained therein. For a full statement of the Standard Terms and the exclusive rights and remedies thereunder, please visit Mini-Circuits' website at [www.minicircuits.com/MCLStore/terms.jsp](http://www.minicircuits.com/MCLStore/terms.jsp)



# Suspended substrate stripline Band Pass Filter

## ZBSS-3G-S+

50Ω 2000 to 4000 MHz



Generic photo used for illustration purposes only  
CASE STYLE: VY3280

Connectors Model  
SMA - F ZBSS-3G-S+

### Features

- Wide fractional bandwidth design of 66.7%
- 1dB typ. Insertion loss at Center frequency
- Sharp roll-off
- High rejection floor of 90dB typ.
- Stop band up to 25 GHz
- Connectorized package

### Applications

- Satellite communications
- Radiolocation
- Radio Navigation
- Military and defense
- Electronic warfare receiver

### Functional Schematic

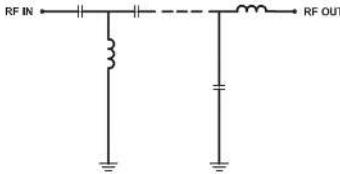

### Typical Frequency Response

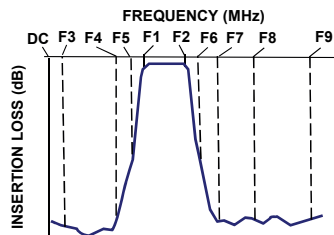

### Electrical Specifications at 25°C

Parameter	F#	Frequency (MHz)	Min.	Typ.	Max.	Unit	
Pass Band	Center Frequency	Fc	3000	-	1.0	-	dB
	Insertion Loss	F1-F2	2000 - 4000	-	1.5	2.5	dB
	VSWR	F1-F2	2000 - 4000	-	1.4	-	:1
Stop Band, Lower	Insertion Loss	DC-F3	DC - 1100	60	90	-	dB
		F3-F4	1100 - 1300	40	60	-	dB
		F4-F5	1300 - 1450	20	35	-	dB
Stop Band, Upper	Insertion Loss	F6-F7	5300 - 6000	20	35	-	dB
		F7-F8	6000 - 7600	40	55	-	dB
		F8-F9	7600 - 25000	60	90	-	dB

### Maximum Ratings

Operating Temperature	-40°C to 85°C
Storage Temperature	-55°C to 100°C
RF Power Input	10W max. @ 25°C

Permanent damage may occur if any of these limits are exceeded.

### Typical Performance Data at 25°C

Frequency (MHz)	Insertion Loss (dB)	VSWR (:1)	Frequency (MHz)	Group Delay (nsec)
10	109.84	737.91	2000	1.97
100	119.48	352.82	2100	1.68
600	99.94	837.60	2200	1.51
1100	91.63	123.69	2300	1.38
1300	61.39	66.40	2400	1.28
1450	42.16	39.46	2500	1.21
1600	21.35	17.36	2600	1.15
1750	2.59	1.28	2700	1.10
2000	1.38	1.27	2800	1.07
2500	0.99	1.11	2900	1.04
3000	1.00	1.26	3000	1.01
3500	1.02	1.06	3100	0.98
4000	1.24	1.13	3200	0.97
4400	3.70	2.70	3300	0.96
4850	20.07	15.26	3400	0.96
5300	34.42	19.77	3500	0.96
6000	52.89	22.96	3600	0.96
7600	79.41	28.53	3700	0.96
15000	98.50	34.33	3800	0.98
25000	91.61	5.63	4000	1.03

### +RoHS Compliant

The +Suffix identifies RoHS Compliance. See our web site for RoHS Compliance methodologies and qualifications

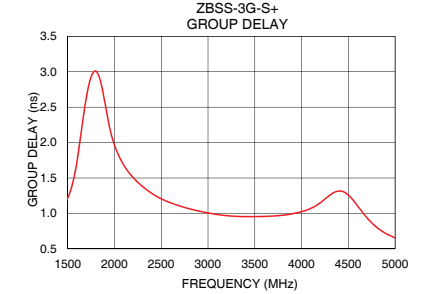
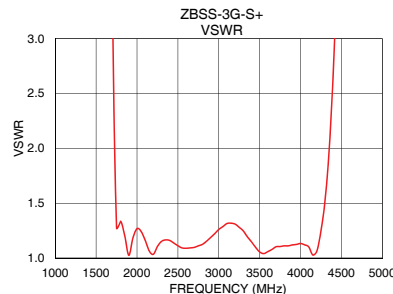
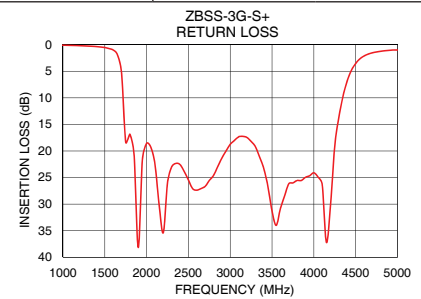
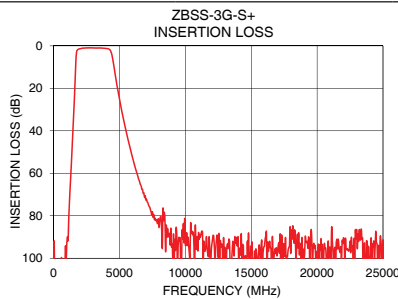

### Notes

- Performance and quality attributes and conditions not expressly stated in this specification document are intended to be excluded and do not form a part of this specification document.
- Electrical specifications and performance data contained in this specification document are based on Mini-Circuit's applicable established test performance criteria and measurement instructions.
- The parts covered by this specification document are subject to Mini-Circuits standard limited warranty and terms and conditions (collectively, "Standard Terms"); Purchasers of this part are entitled to the rights and benefits contained therein. For a full statement of the Standard Terms and the exclusive rights and remedies thereunder, please visit Mini-Circuits' website at [www.minicircuits.com/MCLStore/terms.jsp](http://www.minicircuits.com/MCLStore/terms.jsp)



## Coaxial Connections

PORT - 1	SMA FEMALE
PORT - 2	SMA FEMALE

## Outline Drawing

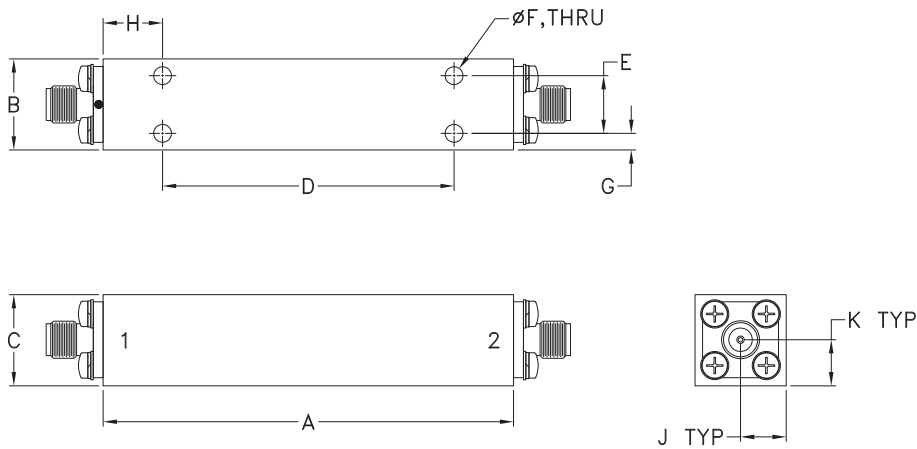

## Outline Dimensions ( $\frac{\text{inch}}{\text{mm}}$ )

A	B	C	D	E	F
2.70	.60	.60	1.920	.380	.110
68.7	15.2	15.2	48.77	9.65	2.80
G	H	J	K	Wt.	
.11	.39	.30	.30	grams	
2.8	9.9	7.6	7.7	120	

Note: Please refer to case style drawing for details

### Notes

- A. Performance and quality attributes and conditions not expressly stated in this specification document are intended to be excluded and do not form a part of this specification document.  
 B. Electrical specifications and performance data contained in this specification document are based on Mini-Circuit's applicable established test performance criteria and measurement instructions.  
 C. The parts covered by this specification document are subject to Mini-Circuits standard limited warranty and terms and conditions (collectively, "Standard Terms"); Purchasers of this part are entitled to the rights and benefits contained therein. For a full statement of the Standard Terms and the exclusive rights and remedies thereunder, please visit Mini-Circuits' website at [www.minicircuits.com/MCLStore/terms.jsp](http://www.minicircuits.com/MCLStore/terms.jsp)

