

THESE DRAWINGS ARE THE PROPERTY OF QUALTEK ELECTRONICS AND NOT TO BE REPRODUCED FOR OR COMMUNICATED TO A THIRD PARTY WITHOUT THE EXPRESS WRITTEN PERMISSION OF AN OFFICER OF QUALTEK ELECTRONICS.

REVISION			
REV.	DESCRIPTION	DATE	APPROVED
B	RoHS Compliancy	06-01-06	DP

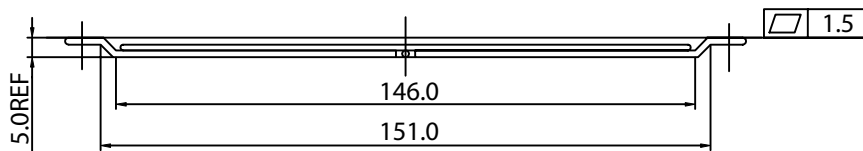
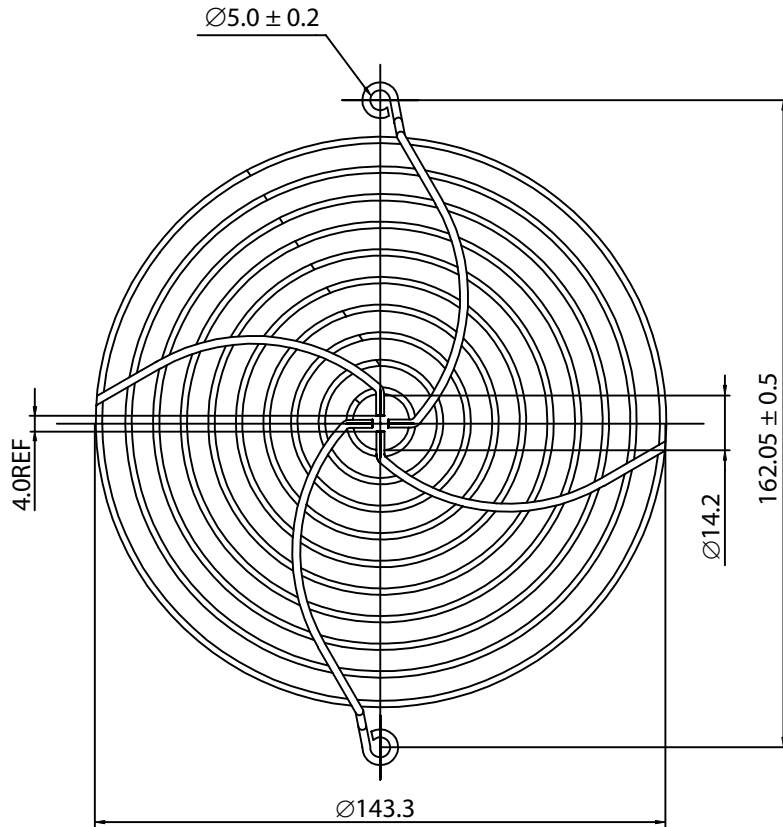

NOTES:

1. MATERIAL: C1008 BRIGHT BASIC WIRE
2. FINISH: BRIGHT NICKEL CHROME PLATING
3. 0.35 ± 0.05 DEPTH OF SERRATIONS ON WIRE
4. RING: $\varnothing 1.6 \pm 0.1\text{mm}$
RIB: $\varnothing 2.0 \pm 0.1\text{mm}$
5. GENERAL TOLERANCE UNLESS NOTED IS $\pm 0.5\text{mm}$
6. RoHS COMPLIANT

CONTROLLED

Dim range (mm)	Tolerance +/- (mm)	Qualtek Electronics Corp. FAN-S DIVISION		
		Part Number:	08169	RoHS Compliant
0-5	0.1	Description: WIRE FORM FAN GUARD (150mm)		
5-16	0.15		UNIT: mm	REV: B
16-64	0.2			
64-250	0.4	Drawn / Date	Checked / Date	Approved / Date
250-1000	0.5	B. ZHANG 08-23-02	08-23-02	JJH / 08-23-02
1000-1500	1.0			