



THIS SPEC IS OBSOLETE

Spec No: 38-05477

Spec Title: CY7C1062DV33, 16-MBIT (512K X 32) STATIC RAM

Replaced by: None

16-Mbit (512K × 32) Static RAM

Features

- High speed
 - $t_{AA} = 10 \text{ ns}$
- Low active power
 - $I_{CC} = 175 \text{ mA}$ at 100 MHz
- Low complementary metal oxide semiconductor (CMOS) standby power
 - $I_{SB2} = 25 \text{ mA}$
- Operating voltages of $3.3 \pm 0.3 \text{ V}$
- 2.0 V data retention
- Automatic power down when deselected
- Transistor-transistor logic (TTL) compatible inputs and outputs
- Easy memory expansion with \overline{CE}_1 , \overline{CE}_2 , and \overline{CE}_3 features
- Available in Pb-free 119-ball plastic ball grid array (PBGA) package

Functional Description

The CY7C1062DV33 is a high performance CMOS Static RAM organized as 524,288 words by 32 bits.

To write to the device, take Chip Enables (\overline{CE}_1 , \overline{CE}_2 , and \overline{CE}_3 LOW) and Write Enable (\overline{WE}) input LOW. If Byte Enable A (\overline{B}_A) is LOW, then data from I/O pins (I/O₀ through I/O₇) is written into the location specified on the address pins (A₀ through A₁₈). If Byte Enable B (\overline{B}_B) is LOW, then data from I/O pins (I/O₈ through I/O₁₅) is written into the location specified on the address pins (A₀ through A₁₈). Likewise, \overline{B}_C and \overline{B}_D correspond with the I/O pins I/O₁₆ to I/O₂₃ and I/O₂₄ to I/O₃₁, respectively.

To read from the device, take Chip Enables (\overline{CE}_1 , \overline{CE}_2 , and \overline{CE}_3 LOW) and Output Enable (\overline{OE}) LOW while forcing the Write Enable (\overline{WE}) HIGH. If the first \overline{B}_A is LOW, then data from the memory location specified by the address pins appear on I/O₀ to I/O₇. If \overline{B}_B is LOW, then data from memory appears on I/O₈ to I/O₁₅. Likewise, \overline{B}_C and \overline{B}_D correspond to the third and fourth bytes. See Truth Table on page 10 for a complete description of read and write modes.

The input and output pins (I/O₀ through I/O₃₁) are placed in a high impedance state when the device is deselected (\overline{CE}_1 , \overline{CE}_2 , or \overline{CE}_3 HIGH), the outputs are disabled (\overline{OE} HIGH), the byte selects are disabled (\overline{B}_{A-D} HIGH), or during a write operation (\overline{CE}_1 , \overline{CE}_2 and \overline{CE}_3 LOW and \overline{WE} LOW).

For a complete list of related documentation, [click here](#).

Logic Block Diagram

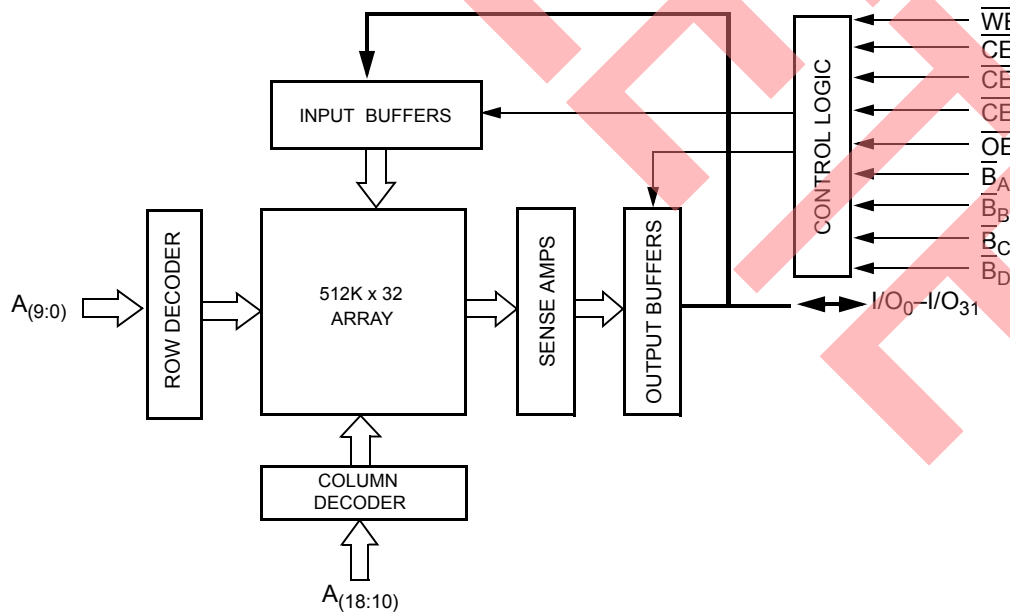

Contents

Selection Guide	3	Ordering Information	11
Pin Configuration	3	Ordering Code Definitions	11
Maximum Ratings	4	Package Diagram	12
Operating Range	4	Acronyms	13
DC Electrical Characteristics	4	Document Conventions	13
Capacitance	5	Units of Measure	13
Thermal Resistance	5	Document History	14
AC Test Loads and Waveforms	5	Sales, Solutions, and Legal Information	15
AC Switching Characteristics	6	Worldwide Sales and Design Support	15
Data Retention Characteristics	7	Products	15
Over the Operating Range	7	PSoC Solutions	15
Data Retention Waveform	7		
Switching Waveforms	7		
Truth Table	10		

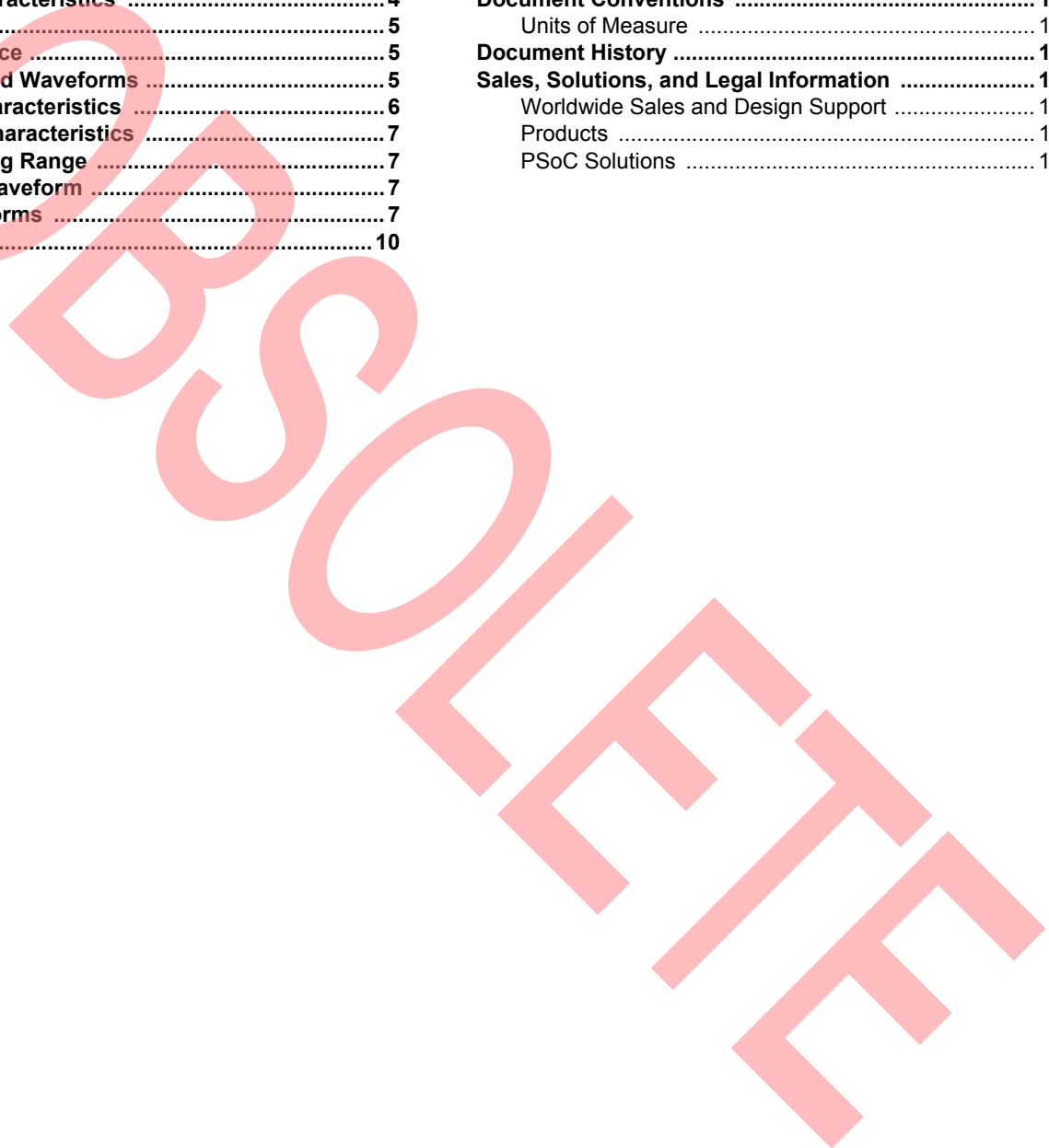

Selection Guide

Description	-10	Unit
Maximum access time	10	ns
Maximum operating current	175	mA
Maximum CMOS standby current	25	mA

Pin Configuration

Figure 1. 119-ball PBGA (Top View) ^[1]

	1	2	3	4	5	6	7
A	I/O ₁₆	A	A	A	A	A	I/O ₀
B	I/O ₁₇	A	A	\overline{CE}_1	A	A	I/O ₁
C	I/O ₁₈	\overline{B}_c	\overline{CE}_2	NC	\overline{CE}_3	\overline{B}_a	I/O ₂
D	I/O ₁₉	V _{DD}	V _{SS}	V _{SS}	V _{SS}	V _{DD}	I/O ₃
E	I/O ₂₀	V _{SS}	V _{DD}	V _{SS}	V _{DD}	V _{SS}	I/O ₄
F	I/O ₂₁	V _{DD}	V _{SS}	V _{SS}	V _{SS}	V _{DD}	I/O ₅
G	I/O ₂₂	V _{SS}	V _{DD}	V _{SS}	V _{DD}	V _{SS}	I/O ₆
H	I/O ₂₃	V _{DD}	V _{SS}	V _{SS}	V _{SS}	V _{DD}	I/O ₇
J	NC	V _{SS}	V _{DD}	V _{SS}	V _{DD}	V _{SS}	NC
K	I/O ₂₄	V _{DD}	V _{SS}	V _{SS}	V _{SS}	V _{DD}	I/O ₈
L	I/O ₂₅	V _{SS}	V _{DD}	V _{SS}	V _{DD}	V _{SS}	I/O ₉
M	I/O ₂₆	V _{DD}	V _{SS}	V _{SS}	V _{SS}	V _{DD}	I/O ₁₀
N	I/O ₂₇	V _{SS}	V _{DD}	V _{SS}	V _{DD}	V _{SS}	I/O ₁₁
P	I/O ₂₈	V _{DD}	V _{SS}	V _{SS}	V _{SS}	V _{DD}	I/O ₁₂
R	I/O ₂₉	A	\overline{B}_d	NC	\overline{B}_b	A	I/O ₁₃
T	I/O ₃₀	A	A	\overline{WE}	A	A	I/O ₁₄
U	I/O ₃₁	A	A	\overline{OE}	A	A	I/O ₁₅

Note

1. NC pins are not connected on the die.

Maximum Ratings

Exceeding maximum ratings may shorten the useful life of the device. These user guidelines are not tested.

Storage temperature	-65 °C to +150 °C
Ambient temperature with power applied	-55 °C to +125 °C
Supply voltage on V _{CC} relative to GND [2]	-0.5 V to +4.6 V
DC voltage applied to outputs in High Z state [2]	-0.5 V to V _{CC} + 0.5 V

DC input voltage [2]	-0.5 V to V _{CC} + 0.5 V
Current into outputs (LOW)	20 mA
Static discharge voltage (MIL-STD-883, method 3015)	>2001 V
Latch-up current	>200 mA

Operating Range

Range	Ambient Temperature	V _{CC}
Industrial	-40 °C to +85 °C	3.3 V ± 0.3 V

DC Electrical Characteristics

Over the Operating Range

Parameter	Description	Test Conditions [3]	-10		Unit
			Min	Max	
V _{OH}	Output HIGH voltage	Min V _{CC} , I _{OH} = -4.0 mA	2.4	-	V
V _{OL}	Output LOW voltage	Min V _{CC} , I _{OL} = 8.0 mA	-	0.4	V
V _{IH}	Input HIGH voltage		2.0	V _{CC} + 0.3	V
V _{IL}	Input LOW voltage [2]		-0.3	0.8	V
I _{Ix}	Input leakage current	GND ≤ V _{IN} ≤ V _{CC}	-1	+1	μA
I _{OZ}	Output leakage current	GND ≤ V _{OUT} ≤ V _{CC} , output disabled	-1	+1	μA
I _{CC}	V _{CC} operating supply current	V _{CC} = Max, f = f _{MAX} = 1/t _{RC} , I _{OUT} = 0 mA, CMOS levels	-	175	mA
I _{SB1}	Automatic CE power-down current – TTL Inputs	Max V _{CC} , $\overline{CE} \geq V_{IH}$, V _{IN} ≥ V _{IH} or V _{IN} ≤ V _{IL} , f = f _{MAX}	-	30	mA
I _{SB2}	Automatic CE power-down current – CMOS Inputs	Max V _{CC} , $\overline{CE} \geq V_{CC} - 0.3$ V, V _{IN} ≥ V _{CC} - 0.3 V, or V _{IN} ≤ 0.3 V, f = 0	-	25	mA

Notes

- V_{IL(min)} = -2.0 V and V_{IH(max)} = V_{CC} + 2 V for pulse durations of less than 20 ns.
- CE indicates a combination of all three chip enables. When active LOW, CE indicates the \overline{CE}_1 , \overline{CE}_2 , and \overline{CE}_3 LOW. When HIGH, CE indicates the \overline{CE}_1 , \overline{CE}_2 , or \overline{CE}_3 HIGH.

Capacitance

Parameter ^[4]	Description	Test Conditions	Max	Unit
C _{IN}	Input capacitance	T _A = 25 °C, f = 1 MHz, V _{CC} = 3.3 V	8	pF
C _{OUT}	I/O capacitance		10	pF

Thermal Resistance

Parameter ^[4]	Description	Test Conditions	119-ball PBGA	Unit
Θ _{JA}	Thermal resistance (Junction to ambient)	Still air, soldered on a 3 × 4.5 inch, four layer printed circuit board.	20.31	°C/W
Θ _{JC}	Thermal resistance (Junction to case)		8.35	°C/W

AC Test Loads and Waveforms

Figure 2. AC Test Loads and Waveforms ^[5]

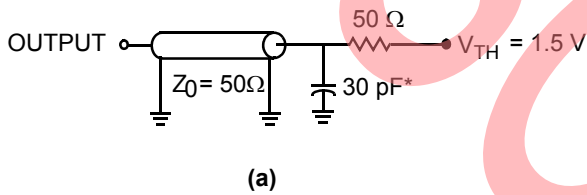

*Capacitive Load consists of all components of the test environment

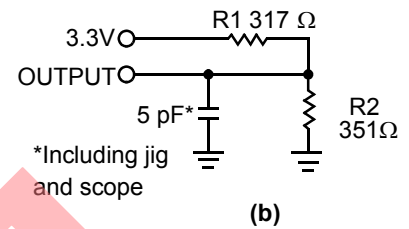

*Including jig and scope

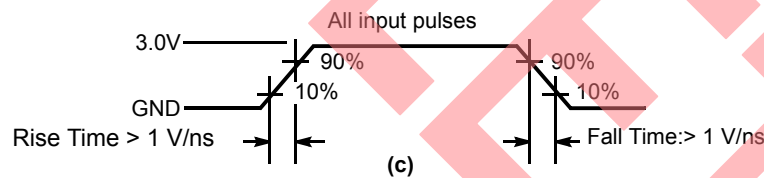

Notes

- 4. Tested initially and after any design or process changes that may affect these parameters.
- 5. Valid SRAM operation does not occur until the power supplies have reached the minimum operating V_{DD} (3.0 V). 100 μs (t_{power}) after reaching the minimum operating V_{DD}, normal SRAM operation begins including reduction in V_{DD} to the data retention (V_{CCDR}, 2.0 V) voltage.

AC Switching Characteristics

Over the Operating Range

Parameter ^[6]	Description	-10		Unit
		Min	Max	
Read Cycle				
t_{power}	$V_{CC}(\text{typical})$ to the first access ^[7]	100	–	μs
t_{RC}	Read cycle time	10	–	ns
t_{AA}	Address to data valid	–	10	ns
t_{OHA}	Data hold from address change	3	–	ns
t_{ACE}	\overline{CE} Active LOW to data valid ^[8]	–	10	ns
t_{DOE}	\overline{OE} LOW to data valid	–	5	ns
t_{LZOE}	\overline{OE} LOW to low Z ^[9]	1	–	ns
t_{HZOE}	\overline{OE} HIGH to high Z ^[9]	–	5	ns
t_{LZCE}	\overline{CE} Active LOW to low Z ^[8, 9]	3	–	ns
t_{HZCE}	\overline{CE} Deselect HIGH to high Z ^[8, 9]	–	5	ns
t_{PU}	\overline{CE} Active LOW to power-up ^[8, 10]	0	–	ns
t_{PD}	\overline{CE} Deselect HIGH to power-down ^[8, 10]	–	10	ns
t_{DBE}	Byte enable to data valid	–	5	ns
t_{LZBE}	Byte enable to low Z ^[9]	1	–	ns
t_{HZBE}	Byte disable to high Z ^[9]	–	5	ns
Write Cycle ^[11, 12]				
t_{WC}	Write cycle time	10	–	ns
t_{SCE}	\overline{CE} Active LOW to write end ^[8]	7	–	ns
t_{AW}	Address setup to write end	7	–	ns
t_{HA}	Address hold from write end	0	–	ns
t_{SA}	Address setup to write start	0	–	ns
t_{PWE}	\overline{WE} pulse width	7	–	ns
t_{SD}	Data setup to write end	5.5	–	ns
t_{HD}	Data hold from write end	0	–	ns
t_{LZWE}	\overline{WE} HIGH to low Z ^[9]	3	–	ns
t_{HZWE}	\overline{WE} LOW to high Z ^[9]	–	5	ns
t_{BW}	Byte enable to end of write	7	–	ns

Notes

- Test conditions assume signal transition time of 3 ns or less, timing reference levels of 1.5V, and input pulse levels of 0 to 3.0V. Test conditions for the read cycle use output loading as shown in (a) of [Figure 2 on page 5](#), unless specified otherwise.
- t_{power} gives the minimum amount of time that the power supply is at typical V_{CC} values until the first memory access is performed.
- \overline{CE} indicates a combination of all three chip enables. When active LOW, \overline{CE} indicates the \overline{CE}_1 , \overline{CE}_2 , and \overline{CE}_3 LOW. When HIGH, \overline{CE} indicates the \overline{CE}_1 , \overline{CE}_2 , or \overline{CE}_3 HIGH.
- t_{HZOE} , t_{HZCE} , t_{HZWE} , t_{HZBE} , t_{LZOE} , t_{LZCE} , t_{LZWE} , and t_{LZBE} are specified with a load capacitance of 5 pF as in (b) of [Figure 2 on page 5](#). Transition is measured ± 200 mV from steady state voltage.
- These parameters are guaranteed by design and are not tested.
- The internal write time of the memory is defined by the overlap of \overline{CE}_1 LOW, \overline{CE}_2 LOW, \overline{CE}_3 LOW and \overline{WE} LOW. Chip enables must be active and \overline{WE} must be LOW to initiate a write, and the transition of any of these signals terminate the write. The input data setup and hold timing are referenced to the leading edge of the signal that terminates the write.
- The minimum write cycle time for Write Cycle No.2 (\overline{WE} controlled, \overline{OE} LOW) is the sum of t_{HZWE} and t_{SD} .

Data Retention Characteristics

Over the Operating Range

Parameter	Description	Conditions [13]	Min	Typ [14]	Max	Unit
V_{DR}	V_{CC} for data retention		2	–	–	V
I_{CCDR}	Data retention current	$V_{CC} = 2\text{ V}$, $\overline{CE} \geq V_{CC} - 0.2\text{ V}$, $V_{IN} \geq V_{CC} - 0.2\text{ V}$, or $V_{IN} \leq 0.2\text{ V}$	–	–	25	mA
$t_{CDR}^{[15]}$	Chip deselect to data retention time		0	–	–	ns
$t_R^{[16]}$	Operation recovery time		t_{RC}	–	–	ns

Data Retention Waveform

Figure 3. Data Retention Waveform

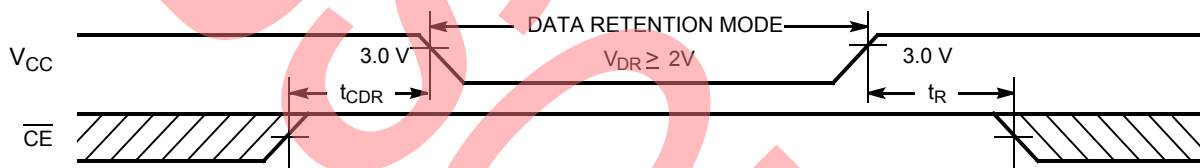

Switching Waveforms

Figure 4. Read Cycle No. 1 (Address Transition Controlled) [17, 18]

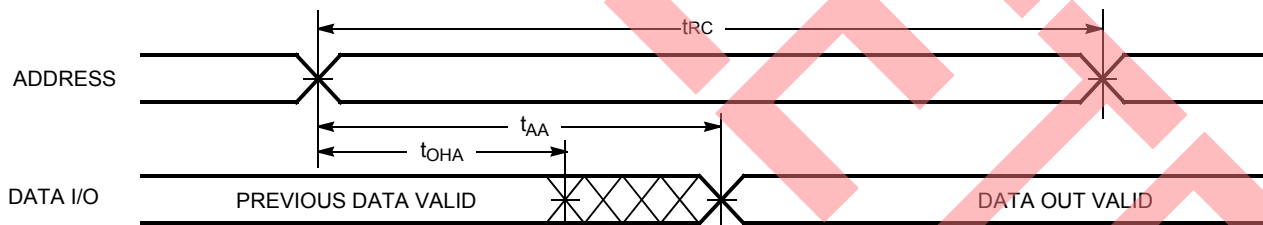

Notes

13. \overline{CE} indicates a combination of all three chip enables. When active LOW, \overline{CE} indicates the \overline{CE}_1 , \overline{CE}_2 , and \overline{CE}_3 LOW. When HIGH, \overline{CE} indicates the \overline{CE}_1 , \overline{CE}_2 , or \overline{CE}_3 HIGH.
14. Typical values are included for reference only and are not guaranteed or tested. Typical values are measured at $V_{CC} = V_{CC(typ)}$, $T_A = 25^\circ\text{C}$.
15. Tested initially and after any design or process changes that affects these parameters.
16. Full device operation requires linear V_{CC} ramp from V_{DR} to $V_{CC(min)} \geq 50\ \mu\text{s}$ or stable at $V_{CC(min)} \geq 50\ \mu\text{s}$.
17. Device is continuously selected. \overline{OE} , \overline{CE} , \overline{B}_A , \overline{B}_B , \overline{B}_C , $\overline{B}_D = V_{IL}$.
18. \overline{WE} is HIGH for read cycle.

Switching Waveforms (continued)

Figure 5. Read Cycle No. 2 (\overline{OE} Controlled) [19, 20, 21]

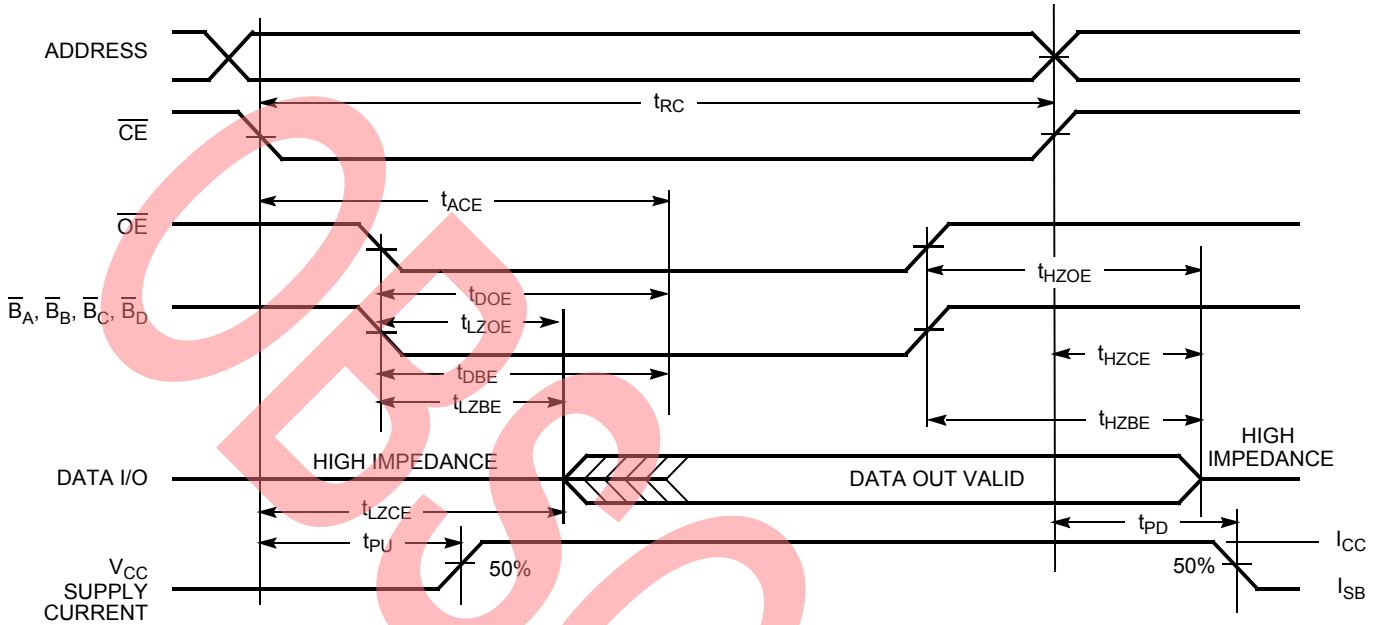
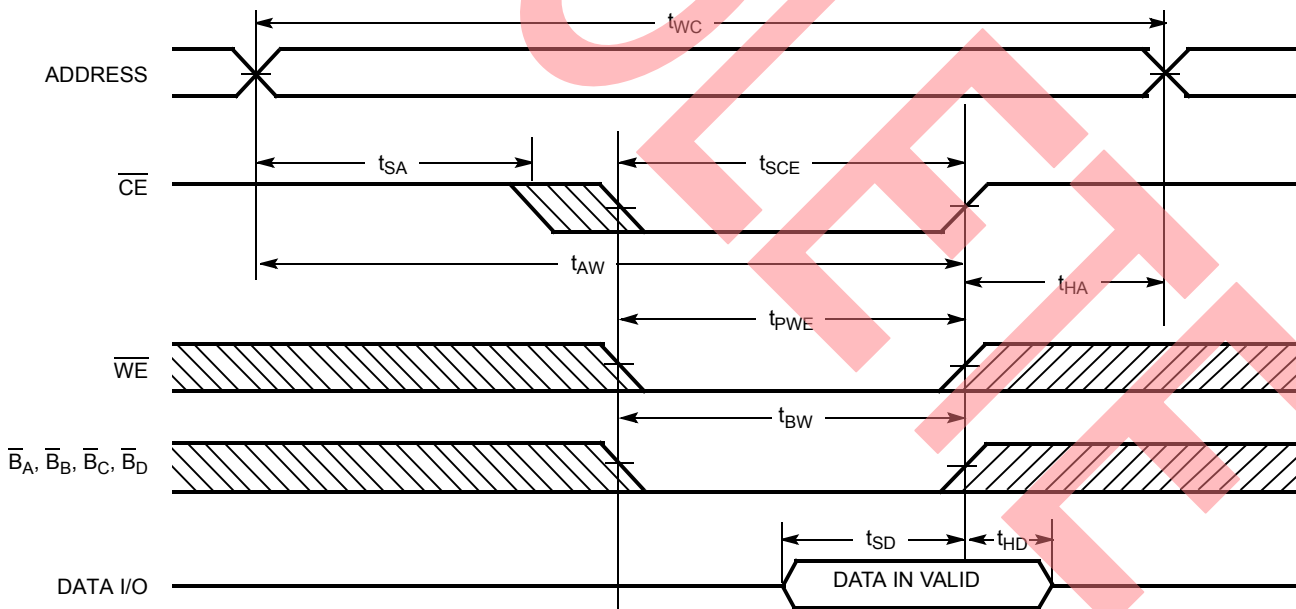

Figure 6. Write Cycle No. 1 (\overline{CE} Controlled) [19, 21, 22, 23]



Notes

- 19. \overline{CE} indicates a combination of all three chip enables. When active LOW, \overline{CE} indicates the \overline{CE}_1 , \overline{CE}_2 , and \overline{CE}_3 LOW. When HIGH, \overline{CE} indicates the \overline{CE}_1 , \overline{CE}_2 , or \overline{CE}_3 HIGH.
- 20. \overline{WE} is HIGH for read cycle.
- 21. Address valid before or similar to \overline{CE} transition LOW.
- 22. Data I/O is high impedance if \overline{OE} or \overline{BA} , \overline{BB} , \overline{BC} , \overline{BD} = V_{IH} .
- 23. If \overline{CE} goes HIGH simultaneously with \overline{WE} going HIGH, the output remains in a high impedance state.

Switching Waveforms (continued)

Figure 7. Write Cycle No. 2 (\overline{WE} Controlled, \overline{OE} LOW) [24, 25, 26, 27]

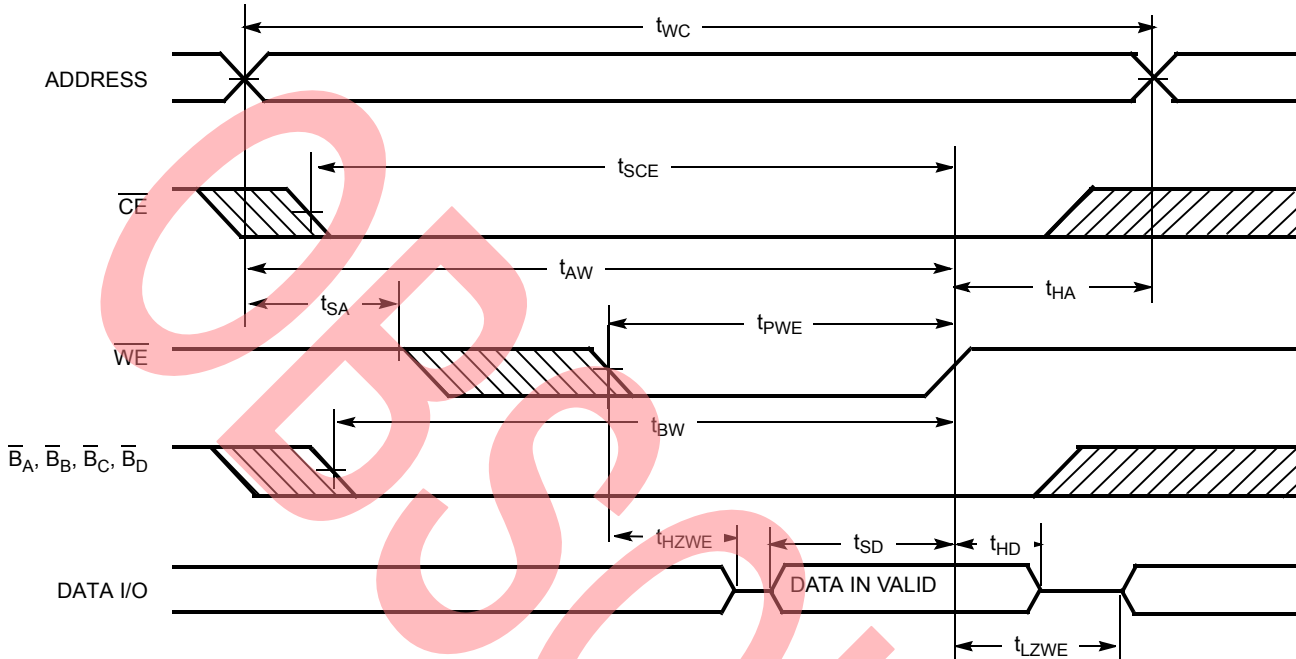
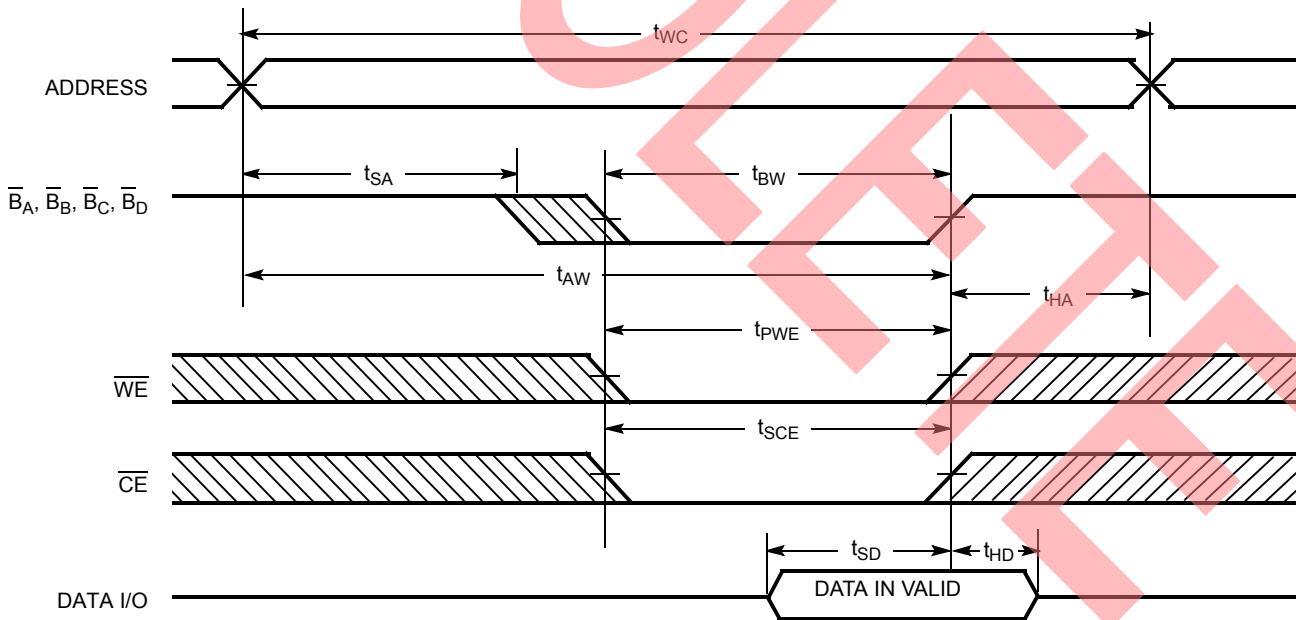

Figure 8. Write Cycle No. 3 (\overline{BA} , \overline{BB} , \overline{BC} , \overline{BD} Controlled) [24]



Notes

- 24. \overline{CE} indicates a combination of all three chip enables. When active LOW, \overline{CE} indicates the \overline{CE}_1 , \overline{CE}_2 , and \overline{CE}_3 LOW. When HIGH, \overline{CE} indicates the \overline{CE}_1 , \overline{CE}_2 , or \overline{CE}_3 HIGH.
- 25. Address valid before or similar to \overline{CE} transition LOW.
- 26. Data I/O is high impedance if \overline{OE} or \overline{BA} , \overline{BB} , \overline{BC} , \overline{BD} = V_{IH} .
- 27. If \overline{CE} goes HIGH simultaneously with \overline{WE} going HIGH, the output remains in a high impedance state.

Truth Table

\overline{CE}_1	\overline{CE}_2	\overline{CE}_3	\overline{OE}	\overline{WE}	\overline{B}_A	\overline{B}_B	\overline{B}_C	\overline{B}_D	I/O ₀ –I/O ₇	I/O ₈ –I/O ₁₅	I/O ₁₆ –I/O ₂₃	I/O ₂₄ –I/O ₃₁	Mode	Power
H	X	X	X	X	X	X	X	X	High Z	High Z	High Z	High Z	power-down	(I _{SB})
X	H	X	X	X	X	X	X	X	High Z	High Z	High Z	High Z	power-down	(I _{SB})
X	X	H	X	X	X	X	X	X	High Z	High Z	High Z	High Z	power-down	(I _{SB})
L	L	L	L	H	L	L	L	L	Data out	Data out	Data out	Data out	Read all bits	(I _{CC})
L	L	L	L	H	L	H	H	H	Data out	High Z	High Z	High Z	Read byte A bits only	(I _{CC})
L	L	L	L	H	H	L	H	H	High Z	Data out	High Z	High Z	Read byte B bits only	(I _{CC})
L	L	L	L	H	H	H	L	H	High Z	High Z	Data out	High Z	Read byte C bits only	(I _{CC})
L	L	L	L	H	H	H	H	L	High Z	High Z	High Z	Data out	Read Byte D bits only	(I _{CC})
L	L	L	X	L	L	L	L	L	Data in	Data in	Data in	Data in	Write all bits	(I _{CC})
L	L	L	X	L	L	H	H	H	Data in	High Z	High Z	High Z	Write byte A bits only	(I _{CC})
L	L	L	X	L	H	L	H	H	High Z	Data in	High Z	High Z	Write byte B bits only	(I _{CC})
L	L	L	X	L	H	H	L	H	High Z	High Z	Data in	High Z	Write byte C bits only	(I _{CC})
L	L	L	X	L	H	H	H	L	High Z	High Z	High Z	Data in	Write byte D bits only	(I _{CC})
L	L	L	H	H	X	X	X	X	High Z	High Z	High Z	High Z	Selected, outputs disabled	(I _{CC})
L	L	L	X	X	H	H	H	H	High Z	High Z	High Z	High Z	Selected, outputs disabled	(I _{CC})

Ordering Information

Speed (ns)	Ordering Code	Package Diagram	Package Type	Operating Range
10	CY7C1062DV33-10BGI	51-85115	119-ball Plastic Ball Grid Array (14 × 22 × 2.4 mm)	Industrial
	CY7C1062DV33-10BGXI		119-ball Plastic Ball Grid Array (14 × 22 × 2.4 mm) (Pb-free)	

Ordering Code Definitions

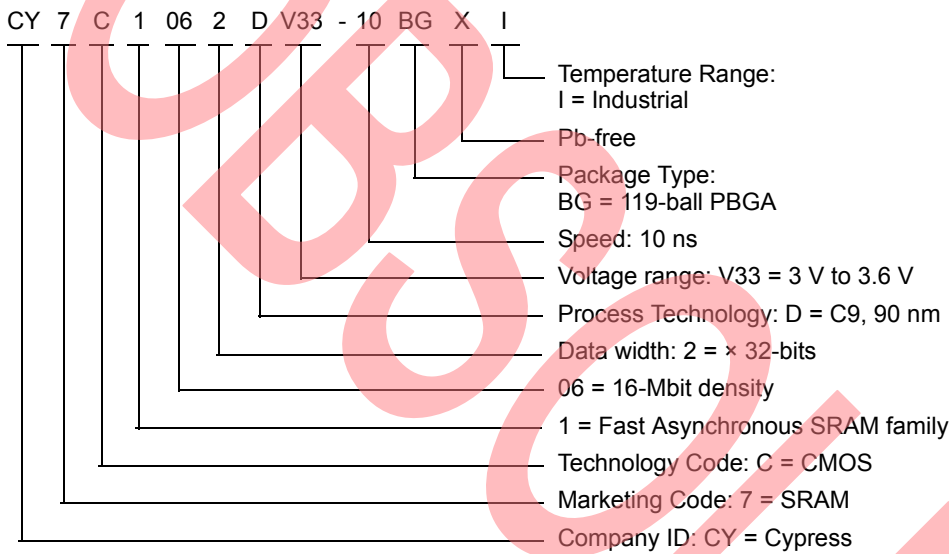

Package Diagram

Figure 9. 119-ball PBGA (14 × 22 × 2.4 mm) BG119 Package Outline, 51-85115

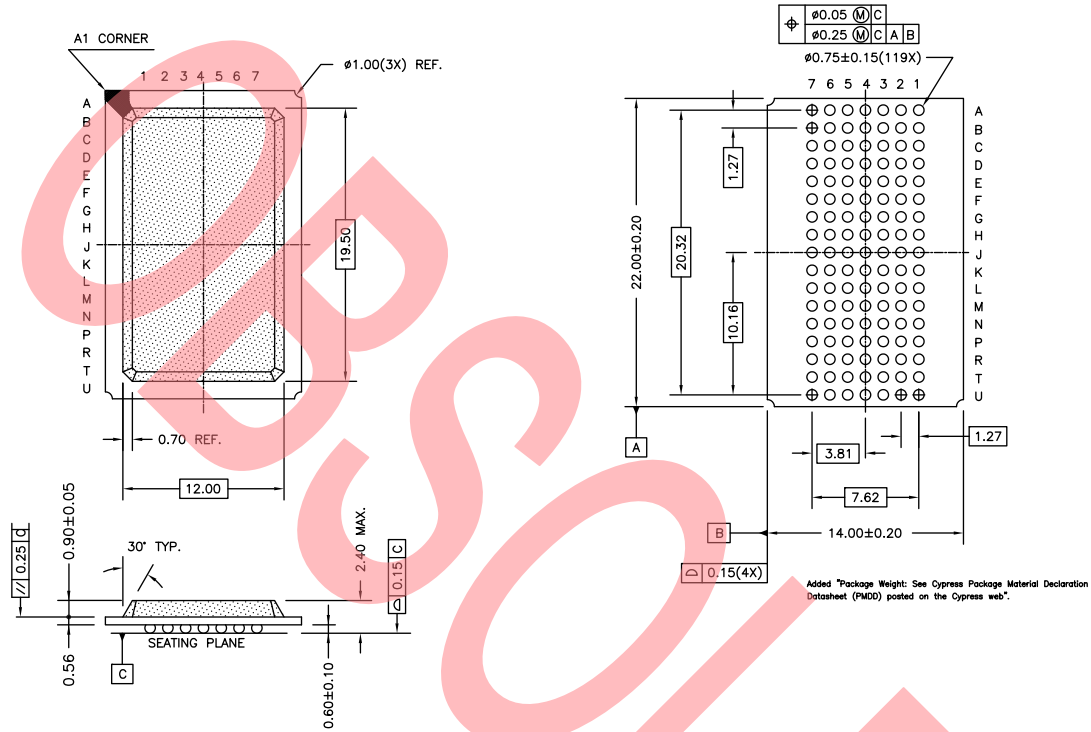

51-85115 *D

Acronyms

Acronym	Description
CE	chip enable
CMOS	complementary metal oxide semiconductor
I/O	input/output
OE	output enable
PBGA	plastic ball grid array
SRAM	static random access memory
TTL	transistor-transistor logic
WE	write enable

Document Conventions

Units of Measure

Symbol	Unit of Measure
°C	degree Celsius
MHz	megahertz
μA	microampere
μs	microsecond
mA	milliampere
ns	nanosecond
Ω	ohm
%	percent
pF	picofarad
V	volt
W	watt

Document History

Document Title: CY7C1062DV33, 16-Mbit (512K × 32) Static RAM				
Document Number: 38-05477				
Rev.	ECN No.	Orig. of Change	Submission Date	Description of Change
**	201560	SWI	See ECN	Advance data sheet for C9 IPP
*A	233748	RKF	See ECN	AC, DC parameters are modified as per EROS (Spec # 01-2165) Pb-free offering in the Ordering Information
*B	469420	NXR	See ECN	Converted from Advance Information to Preliminary Removed –8 and –12 speed bins from product offering Removed Commercial operating Range Changed J7 Ball of PBGA from DNU to NC in the pinout diagram Included the Maximum ratings for Static Discharge Voltage and Latch Up Current on page 2 Changed $I_{CC(Max)}$ from 220 mA to 150 mA Changed $I_{SB1(Max)}$ from 70 mA to 30 mA Changed $I_{SB2(Max)}$ from 40 mA to 25 mA Specified the Overshoot specification in footnote 1 Changed t_{SD} from 5.5 ns to 5 ns Added Data Retention Characteristics table and waveform on page 5. Updated the 48-pin FBGA package Updated the Ordering Information Table
*C	499604	NXR	See ECN	Added note 1 for NC pins Updated Test Condition for I_{CC} in DC Electrical Characteristics table Added note for t_{ACE} , t_{LZCE} , t_{HZCE} , t_{PU} , t_{PD} , and t_{SCE} in AC Switching Characteristics Table on page 4
*D	1462583	VKN / AESA	See ECN	Converted from preliminary to final Updated block diagram Changed I_{CC} spec from 150 mA to 175 mA Updated thermal specs
*E	2541850	VKN / PYRS	07/22/08	Added -10BGI part in the Ordering Information table
*F	3109102	AJU	12/13/2010	Added Ordering Code Definitions . Updated Package Diagram .
*G	3137613	PRAS	01/13/2011	Added Acronyms and Units of Measure . Updated all footnotes sequentially Updated to new template.
*H	3416006	TAVA	10/20/2011	Updated Features . Updated DC Electrical Characteristics . Updated Switching Waveforms . Updated to new template.
*I	4574311	TAVA	11/19/2014	Updated Functional Description : Added “For a complete list of related documentation, click here .” at the end. Updated Package Diagram : spec 51-85115 – Changed revision from *C to *D.
*J	5529532	VINI	11/22/2016	Obsolete document. Completing Sunset Review.

Sales, Solutions, and Legal Information

Worldwide Sales and Design Support

Cypress maintains a worldwide network of offices, solution centers, manufacturer's representatives, and distributors. To find the office closest to you, visit us at cypress.com/sales.

Products

Automotive	cypress.com/go/automotive
Clocks & Buffers	cypress.com/go/clocks
Interface	cypress.com/go/interface
Lighting & Power Control	cypress.com/go/powerpsoc
	cypress.com/go/plc
Memory	cypress.com/go/memory
Optical & Image Sensing	cypress.com/go/image
PSoC	cypress.com/go/psoc
Touch Sensing	cypress.com/go/touch
USB Controllers	cypress.com/go/USB
Wireless/RF	cypress.com/go/wireless

PSoC Solutions

psoc.cypress.com/solutions

PSoC 1 | PSoC 3 | PSoC 5

© Cypress Semiconductor Corporation, 2004-2016. The information contained herein is subject to change without notice. Cypress Semiconductor Corporation assumes no responsibility for the use of any circuitry other than circuitry embodied in a Cypress product. Nor does it convey or imply any license under patent or other rights. Cypress products are not warranted nor intended to be used for medical, life support, life saving, critical control or safety applications, unless pursuant to an express written agreement with Cypress. Furthermore, Cypress does not authorize its products for use as critical components in life-support systems where a malfunction or failure may reasonably be expected to result in significant injury to the user. The inclusion of Cypress products in life-support systems application implies that the manufacturer assumes all risk of such use and in doing so indemnifies Cypress against all charges.

Any Source Code (software and/or firmware) is owned by Cypress Semiconductor Corporation (Cypress) and is protected by and subject to worldwide patent protection (United States and foreign), United States copyright laws and international treaty provisions. Cypress hereby grants to licensee a personal, non-exclusive, non-transferable license to copy, use, modify, create derivative works of, and compile the Cypress Source Code and derivative works for the sole purpose of creating custom software and or firmware in support of licensee product to be used only in conjunction with a Cypress integrated circuit as specified in the applicable agreement. Any reproduction, modification, translation, compilation, or representation of this Source Code except as specified above is prohibited without the express written permission of Cypress.

Disclaimer: CYPRESS MAKES NO WARRANTY OF ANY KIND, EXPRESS OR IMPLIED, WITH REGARD TO THIS MATERIAL, INCLUDING, BUT NOT LIMITED TO, THE IMPLIED WARRANTIES OF MERCHANTABILITY AND FITNESS FOR A PARTICULAR PURPOSE. Cypress reserves the right to make changes without further notice to the materials described herein. Cypress does not assume any liability arising out of the application or use of any product or circuit described herein. Cypress does not authorize its products for use as critical components in life-support systems where a malfunction or failure may reasonably be expected to result in significant injury to the user. The inclusion of Cypress' product in a life-support systems application implies that the manufacturer assumes all risk of such use and in doing so indemnifies Cypress against all charges.

Use may be limited by and subject to the applicable Cypress software license agreement.