

FEATURES

Very High DC Precision

- 30 μV max Offset Voltage
- 0.3 $\mu\text{V}/^\circ\text{C}$ max Offset Voltage Drift
- 0.35 μV p-p max Voltage Noise (0.1 Hz to 10 Hz)
- 5 Million V/V min Open Loop Gain
- 130 dB min CMRR
- 120 dB min PSRR

Matching Characteristics

- 30 μV max Offset Voltage Match
- 0.3 $\mu\text{V}/^\circ\text{C}$ max Offset Voltage Drift Match
- 130 dB min CMRR Match

Single Version: AD707

Available in 8-Pin Plastic Mini-DIP,
Hermetic Cerdip and TO-99 Metal Can
Packages, Chips and /883B Parts Available.

PRODUCT DESCRIPTION

The AD708 is a very high precision, dual monolithic operational amplifier. Each amplifier individually offers excellent dc precision with the best available max offset voltage and offset voltage drift of any dual bipolar op amp. In addition, the matching specifications are the best available in any dual op amp.

The AD708 sets a new standards for dual precision op amps by providing 5 V/ μV min open loop gain and guaranteed max input voltage noise of 350 nV p-p (0.1 Hz to 10 Hz). All dc specifications show excellent stability over temperature, with offset voltage drift typically 0.1 $\mu\text{V}/^\circ\text{C}$ and input bias current drift of 25 pA/ $^\circ\text{C}$ max. Both CMRR (130 dB min) and PSRR (120 dB min) are an order of magnitude improved over any available single monolithic op amp except the AD707.

The AD708 is available in four performance grades. The AD708J is rated over the commercial temperature range of 0°C to $+70^\circ\text{C}$ and is available in a plastic mini-DIP package. The AD708A and AD708B are rated over the industrial temperature range of -40°C to $+85^\circ\text{C}$ and are available in a cerdip and TO-99 package. The AD708S is rated over the military temperature range of -55°C to $+125^\circ\text{C}$ and is available in cerdip and TO-99 packages. Military versions are available processed to MIL-STD-883B, Rev. C.

REV. B

Information furnished by Analog Devices is believed to be accurate and reliable. However, no responsibility is assumed by Analog Devices for its use, nor for any infringements of patents or other rights of third parties which may result from its use. No license is granted by implication or otherwise under any patent or patent rights of Analog Devices.

CONNECTION DIAGRAMS

TO-99 (H) Package

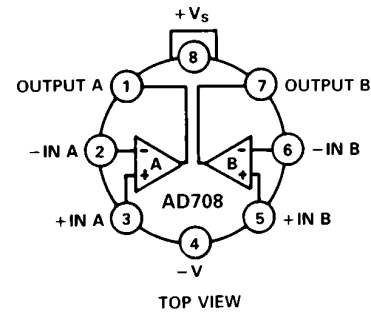

NOTE: PIN 4 CONNECTED TO CASE

Plastic (N), and Cerdip (Q) Packages

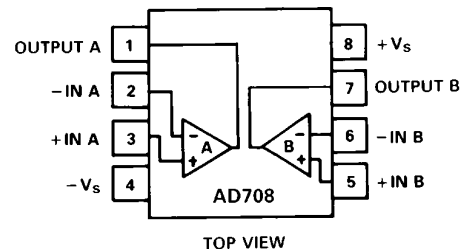

APPLICATION HIGHLIGHTS

1. The combination of outstanding matching and individual specifications make the AD708 ideal for constructing high gain, precision instrumentation amplifiers.
2. The low offset voltage drift and low noise of the AD708 allows the designer to amplify very small signals without sacrificing overall system performance.
3. The AD708's 10 V/ μV typical open loop gain and 140 dB common-mode rejection make it ideal for precision applications.
4. Unmounted dice are available for hybrid circuit applications.
5. The AD708 is an improved replacement for the LT1002.

AD708—SPECIFICATIONS (@ +25°C and ±15 V dc, unless otherwise noted)

Model	Conditions	AD708J/A			AD708B			AD708S			Units	
		Min	Typ	Max	Min	Typ	Max	Min	Typ	Max		
INPUT OFFSET VOLTAGE ¹	T_{MIN} to T_{MAX}		30	100		5	50		5	30	μV	
		Drift		50	150		15	65		15	50	μV
		Long Term Stability		0.3	1.0		0.1	0.4		0.1	0.3	μV/°C
				0.3			0.3			0.3		μV/Month
INPUT BIAS CURRENT	T_{MIN} to T_{MAX}		1.0	2.5		0.5	1.0		0.5	1	nA	
		Average Drift		2.0	4.0		1.0	2.0		1.0	4	nA
				15	40		10	25		10	30	pA/°C
OFFSET CURRENT	$V_{CM} = 0$ V T_{MIN} to T_{MAX}		0.5	2.0		0.1	1.0		0.1	1	nA	
		Average Drift		2.0	4.0		0.2	1.5		0.2	1.5	nA
				2	60		1	25		1	25	pA/°C
MATCHING CHARACTERISTICS ²	T_{MIN} to T_{MAX}	Offset Voltage		80			50			30	μV	
					150		75			50	μV	
		Offset Voltage Drift		1.0			0.4			0.3	μV/°C	
		Input Bias Current		4.0			1.0			1.0	nA	
	Common-Mode Rejection	T_{MIN} to T_{MAX}		120	140		130	140		130	140	dB
				110			130			130		dB
	Power Supply Rejection	T_{MIN} to T_{MAX}		110			120			120	dB	
	Channel Separation	T_{MIN} to T_{MAX}		110			120			120	dB	
			135			140			140	dB		
INPUT VOLTAGE NOISE	0.1 Hz to 10 Hz		0.23	0.6		0.23	0.6		0.23	0.35	μV p-p	
		f = 10 Hz		10.3	18		10.3	12		10.3	12	nV/√Hz
		f = 100 Hz		10.0	13.0		10.0	11.0		10.0	11	nV/√Hz
		f = 1 kHz		9.6	11.0		9.6	11.0		9.6	11	nV/√Hz
INPUT CURRENT NOISE	0.1 Hz to 10 Hz		14	35		14	35		14	35	pA p-p	
		f = 10 Hz		0.32	0.9		0.32	0.8		0.32	0.8	pA/√Hz
		f = 100 Hz		0.14	0.27		0.14	0.23		0.14	0.23	pA/√Hz
		f = 1 kHz		0.12	0.18		0.12	0.17		0.12	0.17	pA/√Hz
COMMON-MODE REJECTION RATIO	$V_{CM} = \pm 13$ V T_{MIN} to T_{MAX}		120	140		130	140		130	140	dB	
			120	140		130	140		130	140	dB	
OPEN-LOOP GAIN	$V_O = \pm 10$ V $R_{LOAD} \geq 2$ kΩ T_{MIN} to T_{MAX}		3	10		5	10		4	10	V/μV	
			3	10		5	10		4	7	V/μV	
POWER SUPPLY REJECTION RATIO	$V_S = \pm 3$ V to ± 18 V T_{MIN} to T_{MAX}		110	130		120	130		120	130	dB	
			110	130		120	130		120	130	dB	
FREQUENCY RESPONSE	Closed Loop Bandwidth		0.5	0.9		0.5	0.9		0.5	0.9	MHz	
		Slew Rate		0.15	0.3		0.15	0.3		0.15	0.3	V/μs
INPUT RESISTANCE	Differential			60			200			200	MΩ	
		Common Mode			200			400			400	GΩ
OUTPUT VOLTAGE	$R_{LOAD} \geq 10$ kΩ $R_{LOAD} \geq 2$ kΩ $R_{LOAD} \geq 1$ kΩ $R_{LOAD} \geq 2$ kΩ T_{MIN} to T_{MAX}		13.5	14		13.5	14.0		13.5	14	±V	
			12.5	13.0		12.5	13.0		12.5	13	±V	
			12.0	12.5		12.0	12.5		12.0	12.5	±V	
			12.0	13.0		12.0	13.0		12.0	13	±V	
			12.0	13.0		12.0	13.0		12.0	13	±V	
OPEN-LOOP OUTPUT RESISTANCE			60			60			60	Ω		

Model	Conditions	AD708J/A			AD708B			AD708S			Units	
		Min	Typ	Max	Min	Typ	Max	Min	Typ	Max		
POWER SUPPLY												
Quiescent Current	$V_S = \pm 15\text{ V}$ No Load	4.5	5.5		4.5	5.5		4.5	5.5		mA	
Power Consumption		$V_S = \pm 3\text{ V}$	135	165		135	165		135	165		mW
			12	18		12	18		12	18		mW
Operating Range		± 3		± 18	± 3		± 18	± 3		± 18	V	

NOTES

¹Input offset voltage specifications are guaranteed after 5 minutes of operation at $T_A = +25^\circ\text{C}$.

²Matching is defined as the difference between parameters of the two amplifiers.

All min and max specifications are guaranteed. Specifications in **boldface** are tested on all production units at final electrical test. Results from those tests are used to calculate outgoing quality levels.

Specifications subject to change without notice.

ABSOLUTE MAXIMUM RATINGS¹

Supply Voltage $\pm 22\text{ V}$

Internal Power Dissipation²

Input Voltage³ $\pm V_S$

Output Short Circuit Duration Indefinite

Differential Input Voltage $+V_S$ and $-V_S$

Storage Temperature Range (Q, H) -65°C to $+150^\circ\text{C}$

Storage Temperature Range (N) -65°C to $+125^\circ\text{C}$

Lead Temperature Range (Soldering 60 sec) $+300^\circ\text{C}$

NOTES

¹Stresses above those listed under “Absolute Maximum Ratings” may cause permanent damage to the device. This is a stress rating only and functional operation of the device at these or any other conditions above those indicated in the operational section of this specification is not implied. Exposure to absolute maximum rating conditions for extended periods may affect device reliability.

²Thermal Characteristics

8-Pin Plastic Package: $\theta_{JC} = 33^\circ\text{C/Watt}$, $\theta_{JA} = 100^\circ\text{C/Watt}$

8-Pin Cerdip package: $\theta_{JC} = 30^\circ\text{C/Watt}$, $\theta_{JA} = 110^\circ\text{C/Watt}$

8-Pin Metal Can Package: $\theta_{JC} = 65^\circ\text{C/Watt}$, $\theta_{JA} = 150^\circ\text{C/Watt}$.

³For supply voltages less than $\pm 22\text{ V}$, the absolute maximum input voltage is equal to the supply voltage.

METALIZATION PHOTOGRAPH

Dimensions shown in inches and (mm).

Contact factory for latest dimensions.

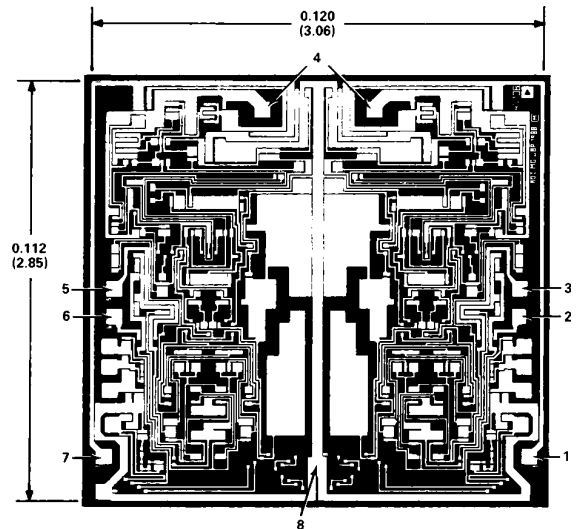

ORDERING GUIDE

Model	Temperature Range	Package Description	Package Option*
AD708JN	0°C to $+70^\circ\text{C}$	8-Pin Plastic DIP	N-8
AD708AQ	-40°C to $+85^\circ\text{C}$	8-Pin Cerdip	Q-8
AD708BQ	-40°C to $+85^\circ\text{C}$	8-Pin Cerdip	Q-8
AD708SQ	-55°C to $+125^\circ\text{C}$	8-Pin Cerdip	Q-8
AD708AH	-40°C to $+85^\circ\text{C}$	8-Pin Header	H-08A
AD708BH	-40°C to $+85^\circ\text{C}$	8-Pin Header	H-08A
AD708SH	-55°C to $+125^\circ\text{C}$	8-Pin Header	H-08A
AD708SH/883B	-55°C to $+125^\circ\text{C}$	8-Pin Header	H-08A
AD708J Grade Chips	0°C to $+70^\circ\text{C}$	Die	
AD708S Grade Chips	-55°C to $+125^\circ\text{C}$	Die	

*N = Plastic DIP; Q = Cerdip; H = Hermetic Metal Can.

AD708—Typical Characteristics ($V_S = \pm 15\text{ V}$ and $T_A = +25^\circ\text{C}$ unless otherwise noted)

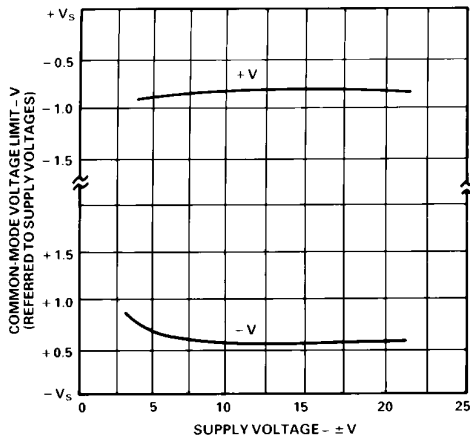

Figure 1. Input Common-Mode Range vs. Supply Voltage

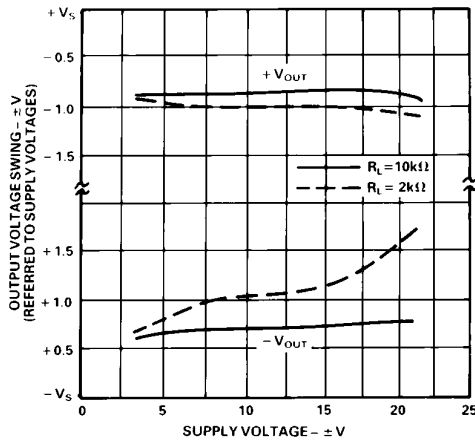

Figure 2. Output Voltage Swing vs. Supply Voltage

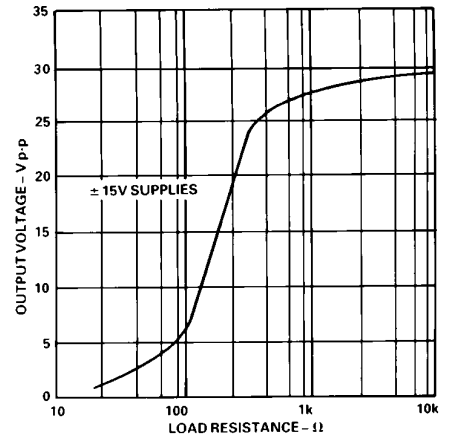

Figure 3. Output Voltage Swing vs. Load Resistance

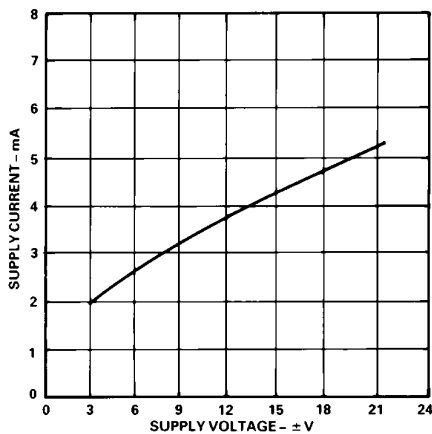

Figure 4. Supply Current vs. Supply Voltage

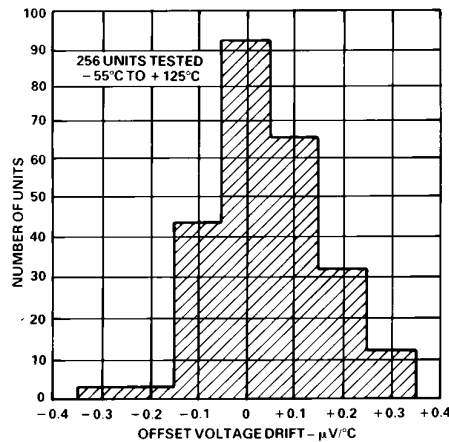

Figure 5. Typical Distribution of Offset Voltage Drift

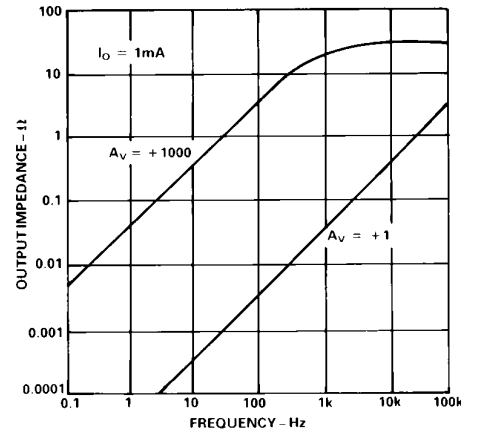

Figure 6. Output Impedance vs. Frequency

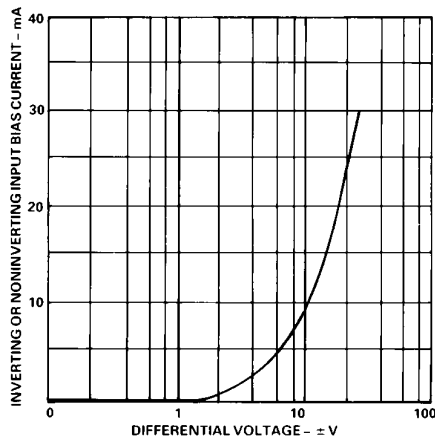

Figure 7. Input Bias Current vs. Differential Input Voltage

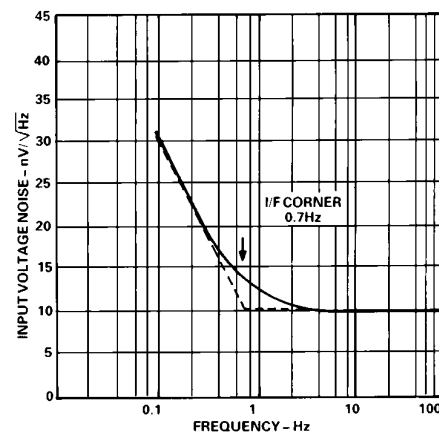

Figure 8. Input Noise Spectral Density

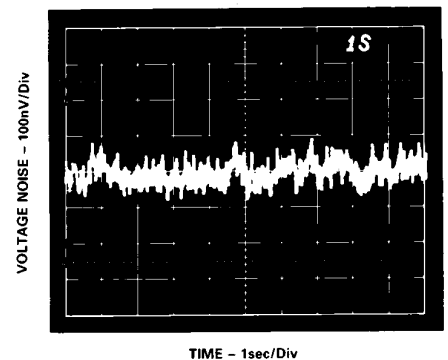

Figure 9. 0.1Hz to 10Hz Voltage Noise

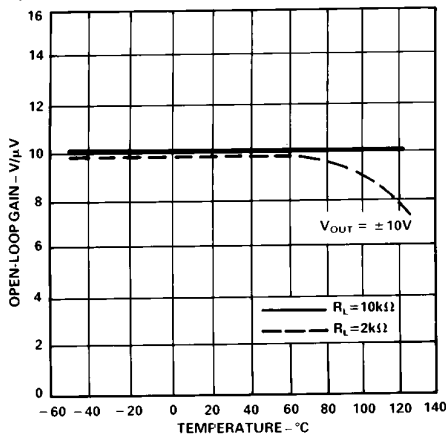

Figure 10. Open-Loop Gain vs. Temperature

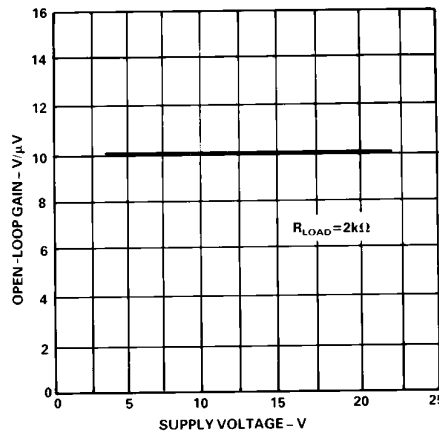

Figure 11. Open-Loop Gain vs. Supply Voltage

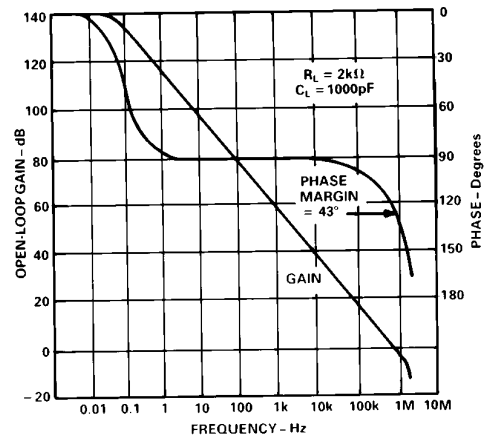

Figure 12. Open-Loop Gain and Phase vs. Frequency

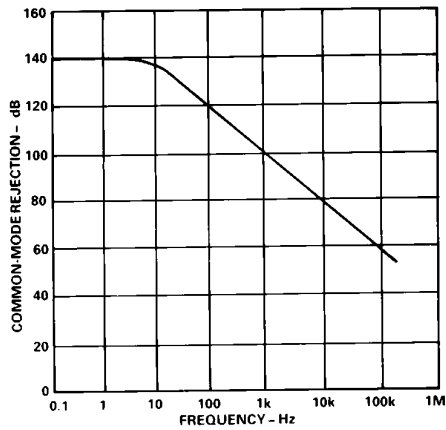

Figure 13. Common-Mode Rejection vs. Frequency

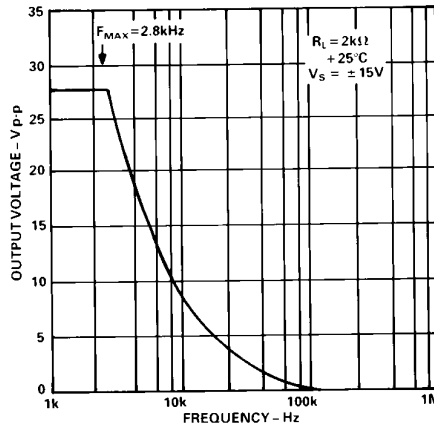

Figure 14. Large Signal Frequency Response

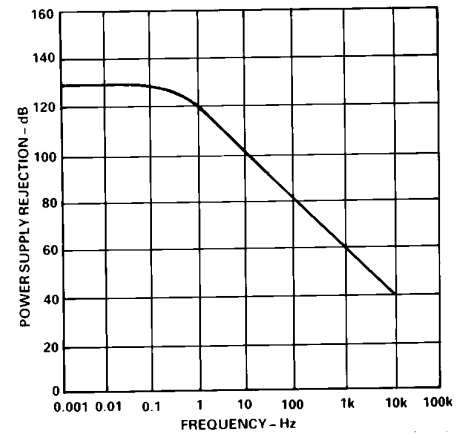

Figure 15. Power Supply Rejection vs. Frequency

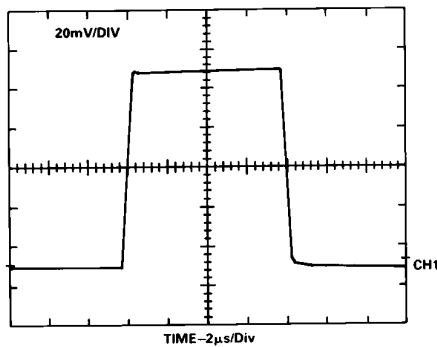

Figure 16. Small Signal Transient Response;
 $A_V = +1$, $R_L = 2k\Omega$, $C_L = 50pF$

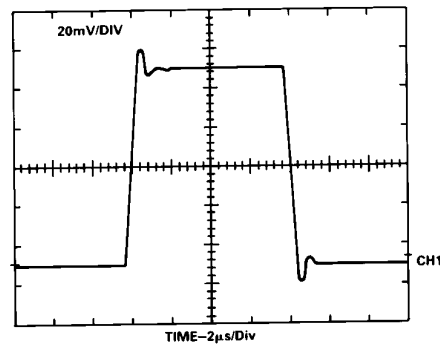

Figure 17. Small Signal Transient Response;
 $A_V = +1$, $R_L = 2k\Omega$, $C_L = 1000pF$

AD708—Matching Characteristics

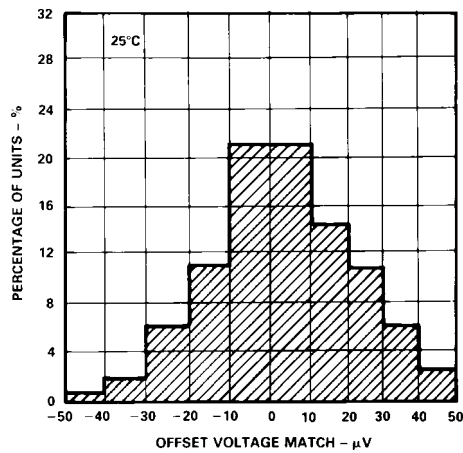

Figure 18. Typical Distribution of Offset Voltage Match

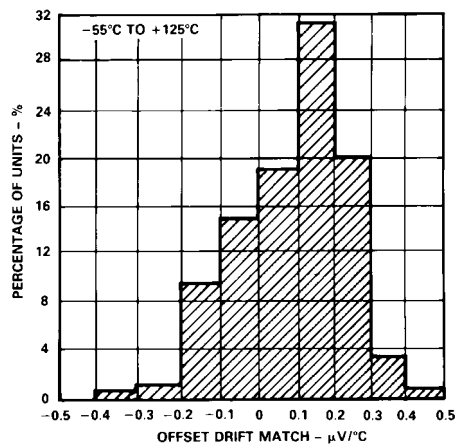

Figure 19. Typical Distribution of Offset Voltage Drift Match

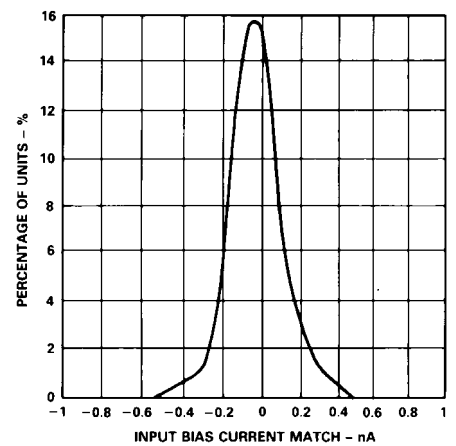

Figure 20. Typical Distribution of Input Bias Current Match

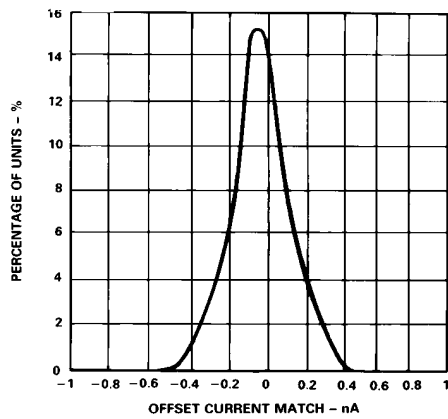

Figure 21. Typical Distribution of Input Offset Current Match

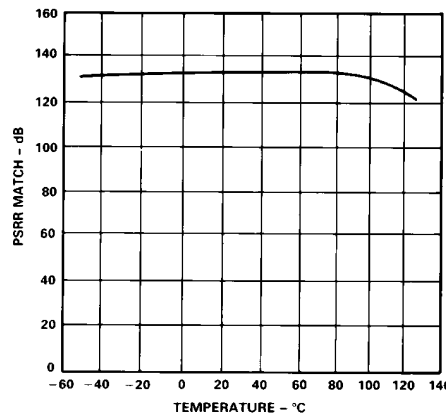

Figure 22. PSRR Match vs. Temperature

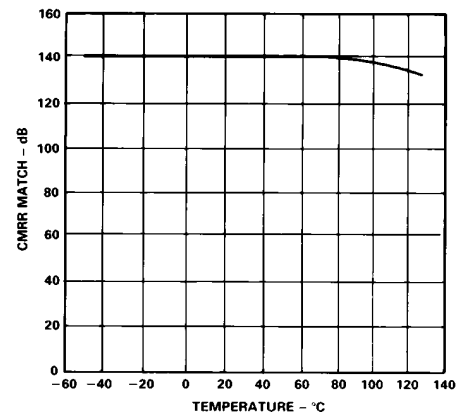

Figure 23. CMRR Match vs. Temperature

Crosstalk from Thermal Effects of Power Dissipation

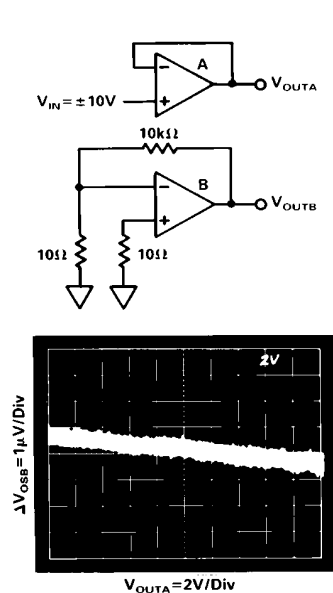

Figure 24. Crosstalk with No Load

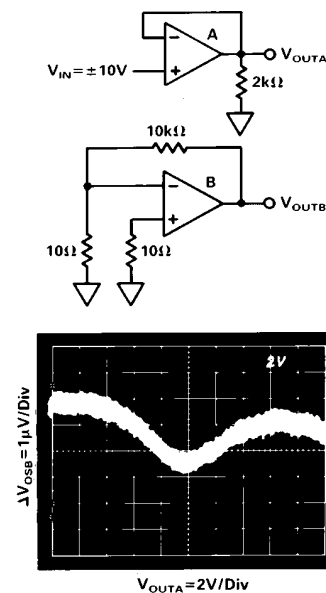

Figure 25. Crosstalk with 2 kΩ Load

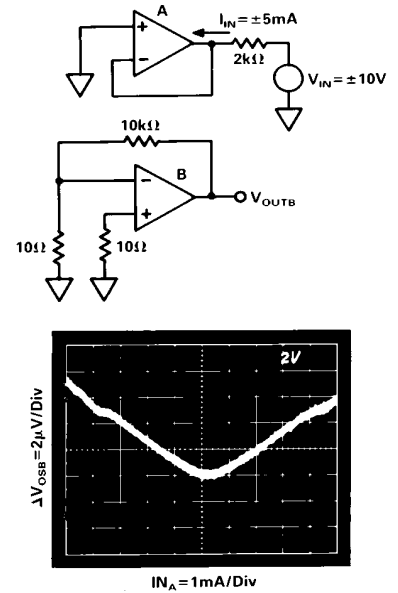

Figure 26. Crosstalk under Forced Source and Sink Conditions

CROSSTALK PERFORMANCE OF THE AD708

The AD708 exhibits very low crosstalk as shown in Figures 24, 25 and 26. Figure 24 shows the offset voltage induced in side B of the AD708 when side A's output is moving slowly (0.2 Hz) from -10 V to +10 V under no load. This is the least stressful situation to the part since the overall power in the chip does not change; only the location of the power in the output devices changes. Figure 25 shows side B's input offset voltage change when side A is driving a 2 kΩ load. Here the power is being changed in the chip with the maximum power change occurring at ±7.5 V. Figure 26 shows crosstalk under the most severe conditions. Side A is connected as a follower with 0 V input, and is now forced to sink and source ±5 mA of output current (Power = (30 V) (5 mA) = 150 mW). Even this large change in power causes only an 8 μV (linear) change in side B's input offset voltage.

OPERATION WITH A GAIN OF -100

To show the outstanding dc precision of the AD708 in real application, Table I shows an error budget calculation for a gain of -100 configuration shown in Figure 27.

Table I.

Error Sources	Maximum Error Contribution A _V = 100 (S Grade) (Full Scale: V _{OUT} = 10 V, V _{IN} = 100 mV)	
	V _{OS}	30 μV/100 mV
I _{OS}	(100 kΩ)(1 nA)/10 V	= 10 ppm
Gain (2 kΩ load)	10 V/(5*10 ⁶)/100 mV	= 20 ppm
Noise	0.35 μV/100 mV	= 4 ppm
V _{OS} Drift	(0.3 μV/°C)/100 mV	= 3 ppm/°C
Total Unadjusted Error		= 334 ppm
	@ 25°C	= 334 ppm > 11 Bits
	-55°C to +125°C	= 634 ppm > 10 Bits
With Offset Calibrated Out	@ 25°C	= 34 ppm > 14 Bits
	-55°C to +125°C	= 334 ppm > 11 Bits

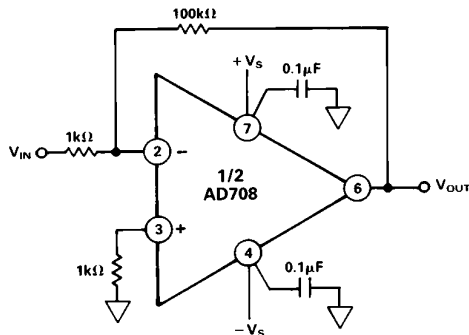

Figure 27. Gain of -100 Configuration

This error budget assumes no error in the resistor ratio and no error from power supply variation (the 120 dB minimum PSRR of the AD708S makes this a good assumption). The external resistors can cause gain error from mismatch and drift over temperature.

High Precision Programmable Gain Amplifier

The three op amp programmable gain amplifier shown in Figure 28 takes advantage of the outstanding matching characteristics of the AD708 to achieve high dc precision. The gains of the circuit

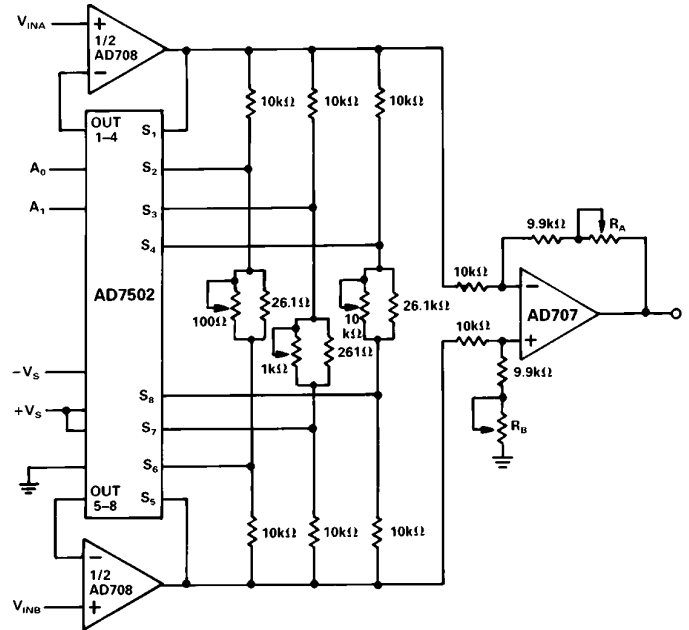

Figure 28. Precision PGA

are controlled by the select lines, A0 and A1 of the AD7502 multiplexer, and are 1, 10, 100 and 1000 in this design.

The input stage attains very high dc precision due to the 30 μV maximum offset voltage match of the AD708S and the 1 nA maximum input bias current match. The accuracy is maintained over temperature because of the ultralow drift performance of the AD708. The output stage uses an AD707J and well matched resistors configured as a precision subtracter.

To achieve 0.1% gain accuracy, along with high common-mode rejection, the circuit should be trimmed as follows:

To maximize common-mode rejection:

1. Set the select lines for Gain = 1 and ground V_{INB}.
2. Apply a precision dc voltage to V_{INA} and trim R_A until V_O = -V_{INA} to the required precision.
3. Next connect V_{INB} to V_{INA} and apply an input voltage equal to the full-scale common-mode expected.
4. Trim R_B until V_O = 0 V.

To minimize gain errors:

1. Select Gain = 10 with the control lines and apply a differential input voltage.
2. Adjust the 100 Ω potentiometer such that V_O = 10 V_{IN} (adjust V_{IN} magnitude as necessary).
3. Repeat for Gain = 100 and Gain = 1000, adjusting 1 kΩ and 10 kΩ potentiometers, respectively.

The design shown should allow for 0.1% gain accuracy and 0.1 μV/V common-mode rejection when ±1% resistors and ±5% potentiometers are used.

BRIDGE SIGNAL CONDITIONER

The AD708 can be used in the circuit in Figure 29 to produce an accurate and inexpensive dynamic bridge conditioner. The low offset voltage match and low offset voltage drift match of the AD708 combine to achieve circuit performance better than all but the best instrumentation amplifiers. The AD708's outstanding specs: open loop gain, input offset currents and low input bias currents, do not limit circuit accuracy.

AD708

As configured, the circuit only requires a gain resistor, R_G , of suitable accuracy and a stable, accurate voltage reference. The transfer function is:

$$V_O = V_{REF} [\Delta R / (R + \Delta R)] / [R_G / R]$$

and the only significant errors due to the AD708S are:

$$V_{OSout} = (V_{OSmatch})(2R_G/R) = 30 \text{ mV}$$

$$V_{OSout}(T) = (V_{OSdrift})(2R_G/R) = 0.3 \text{ mV}/^\circ\text{C}$$

To achieve high accuracy, the resistor R_G should be 0.1% or better and have a low drift coefficient.

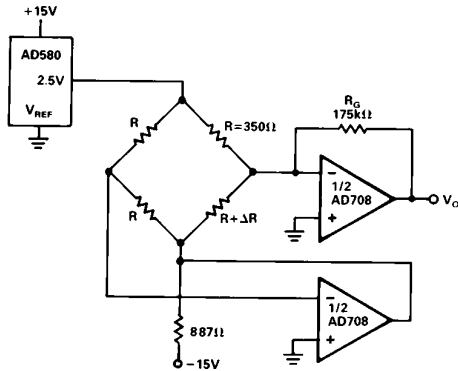

Figure 29. Bridge Signal Conditioning Circuit

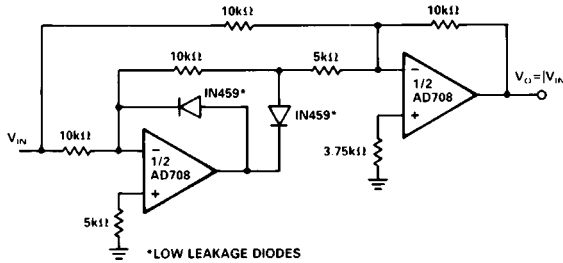

Figure 30. Precision Absolute Value Circuit

PRECISION ABSOLUTE VALUE CIRCUIT

The AD708 is ideally suited to the precision absolute value circuit shown in Figure 30. The low offset voltage match of the AD708 enables this circuit to accurately resolve the input signal. In addition, the tight offset voltage drift match maintains the resolution of the circuit over the full military temperature range. The AD708's high dc open loop gain and exceptional gain linearity allows the circuit to perform well at both large and small signal levels.

In this circuit, the only significant dc errors are due to the offset voltage of the two amplifiers, the input offset current match of the amplifiers, and the mismatch of the resistors. Errors associated with the AD708S contribute less than 0.001% error over -55°C to $+125^\circ\text{C}$.

Maximum error at 25°C

$$\frac{30 \mu\text{V} + (10 \text{ k}\Omega)(1 \text{ nA})}{10 \text{ V}} = 40 \mu\text{V}/10 \text{ V} = 4 \text{ ppm Maximum}$$

error at $+125^\circ\text{C}$ or -55°C

$$\frac{50 \mu\text{V} + (2 \text{ nA})(10 \text{ k}\Omega)}{10 \text{ V}} = 7 \text{ ppm @ } +125^\circ\text{C}$$

Figure 31 shows V_{OUT} vs. V_{IN} for this circuit with a $\pm 3 \text{ mV}$ input signal at 0.05 Hz. Note that the circuit exhibits very low offset at the zero crossing. This circuit can also produce $V_{OUT} = -|V_{IN}|$ by reversing the polarity of the two diodes.

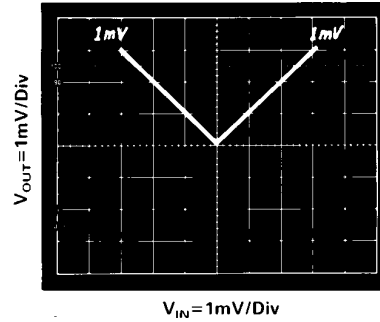

Figure 31. Absolute Value Circuit Performance (Input Signal = 0.05 Hz)

SELECTION OF PASSIVE COMPONENTS

To take full advantage of the high precision and low drift characteristics of the AD708, high quality passive components must be used. Discrete resistors and resistor networks with temperature coefficients of less than 10 ppm/ $^\circ\text{C}$ are available from Vishay, Caddock, PRP and others.

OUTLINE DIMENSIONS

Dimensions shown in inches and (mm).

TO-99 (H) Package

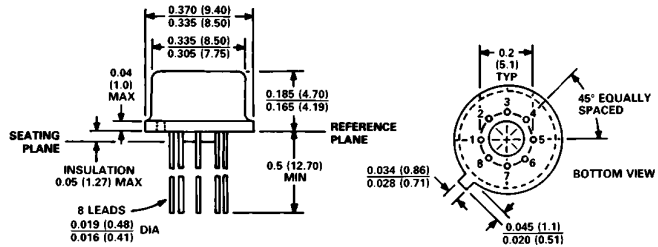

Cerdip (Q) Package

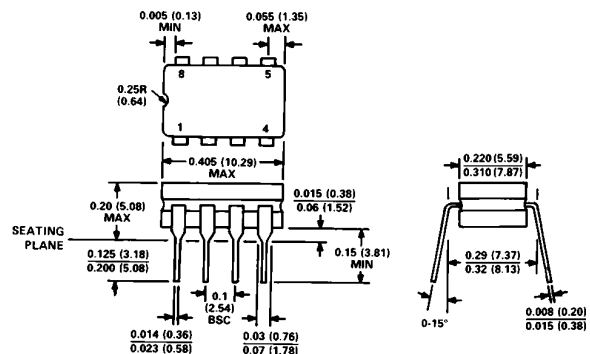

Mini-DIP (N) Package

