

FEATURES

- **SOP (SMALL OUTLINE PACKAGE)**
4.5 x 7.3 x 2.3 mm MAX
- **HIGH SPEED RESPONSE**
 $t_{PHL}, t_{PLH} = 50 \text{ ns TYP}$
- **HIGH ISOLATION VOLTAGE**
 $BV = 2500 \text{ Vr.m.s. MIN}$
- **LOW INPUT CURRENT**
 $I_{FHL} = 2.5 \text{ mA TYP}$
- **TAPING PRODUCT NUMBER**
PS9701-F3

DESCRIPTION

PS9701 is an optically coupled isolator containing a GaAlAs LED on the light emitting side (input side) and a photodiode and a signal processing circuit on the light receiving side (output side) on one chip. This is an SOP (Small Out-line Package) type for high density applications.

APPLICATIONS

- **COMPUTER AND PERIPHERAL MEMORY**
- **ELECTRONIC INSTRUMENT**
- **AUDIO-VISUAL INTERFACE**

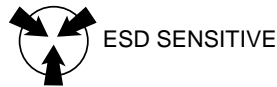

ELECTRICAL CHARACTERISTICS (TA = 25 °C)

PART NUMBER			PS9701			
SYMBOL	PARAMETERS	UNITS	MIN	TYP	MAX	
Diode	V _F	Forward Voltage, I _F = 10 mA	V	1.4	1.9	
	I _R	Reverse Current, V _R = 5 V	μA		10	
	C _t	Capacitance, V = 0, f = 1 MHz	pF	60		
Detector	I _{OH}	High Level Output Current V _{CC} = V _O = 5.5 V, I _F = 250 μA, T _A = 0 to 70°C	μA	2	250	
	V _{OL}	Low Level Output Voltage V _{CC} = 5.5 V, I _F = 7.5 mA, I _O = 13 mA, T _A = 0 to 70°C	V	0.3	0.6	
	I _{CCH}	High Level Supply Current, V _{CC} = 5.5 V, I _F = 0, T _A = 0 to 70°C	mA	4	6	8
	I _{CCL}	Low Level Supply Current, V _{CC} = 5.5 V, I _F = 10 mA, T _A = 0 to 70°C	mA	9	12	15
Coupled	I _{FHL}	Threshold Input Current, High → Low V _{CC} = 5 V, V _O = 0.8 V, R _L = 350 Ω, T _A = 25°C V _{CC} = 5 V, T _A = -40 to +85 °C, V _O = 0.8 V, R _L = 350 Ω	mA	0.5	2.5	5 7
	R ₁₋₂	Isolation Resistance, V _{in-out} = 1 k V _{DC} , R _H = 40 to 60%	Ω	10 ¹¹		
	C ₁₋₂	Isolation Capacitance, V = 0, f = 1 MHz	pF		0.4	
	t _{PHL}	Propagation Delay Time ¹ , High → Low V _{CC} = 5 V, I _F = 7.5 mA, R _L = 350 Ω, C _L = 15 pF	ns		50	75
	t _{PLH}	Propagation Delay Time ¹ , Low → High V _{CC} = 5 V, I _F = 7.5 mA, R _L = 350 Ω, C _L = 15 pF	ns		50	75
	t _r	Rise Time, V _{CC} = 5 V, I _F = 7.5 mA, R _L = 350 Ω, C _L = 15 pF	ns		20	
	t _f	Fall Time, V _{CC} = 5 V, I _F = 7.5 mA, R _L = 350 Ω, C _L = 15 pF	ns		10	

1. Test Circuit for Propagation delay time

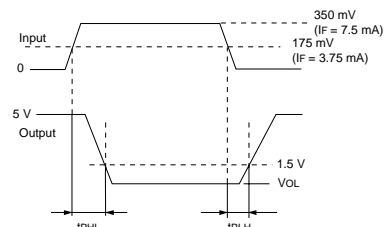
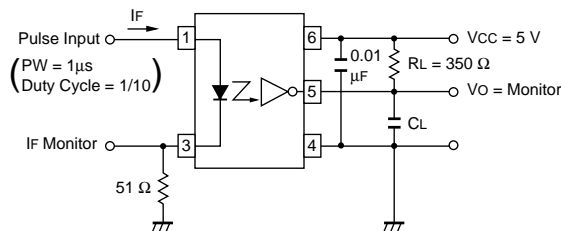

*C_L is approximately 15 pF, which includes probe and stray wiring capacitance.

ABSOLUTE MAXIMUM RATINGS¹ (T_A = 25 °C)

SYMBOLS	PARAMETERS	UNITS	RATINGS
Diode			
I _F	Forward Current	mA	30
V _R	Reverse Voltage	V	5
Detector			
V _{CC}	Supply Voltage	V	7
V _O	Output Voltage	V	7
I _O	Output Current	mA	50
P _C	Power Dissipation	mW	85
Coupled			
BV	Isolation Voltage ²	V _{r.m.s.}	2500
T _{OP}	Operating Temperature	°C	-40 to +85
T _{STG}	Storage Temperature	°C	-55 to +125

Notes:

1. Operation in excess of any one of these parameters may result in permanent damage.
2. AC voltage for 1 minute at T_A = 25 °C, RH = 60% between input and output.

RECOMMENDED OPERATING CONDITIONS

PART NUMBER			PS9701		
SYMBOLS	PARAMETERS	UNITS	MIN	TYP	MAX
I _{FL}	Low Level Input Current	μA	0		250
I _{FH}	High Level Input Current	mA	5	7.5	15
V _{CC}	Supply Voltage	V	4.5	5	5.5
T _{OP}	Operating Temperature	°C	0	25	70

* By-pass capacitor of more than 0.1 μF is used between V_{CC} and GND near the device.

OUTLINE DIMENSIONS (Units in mm)

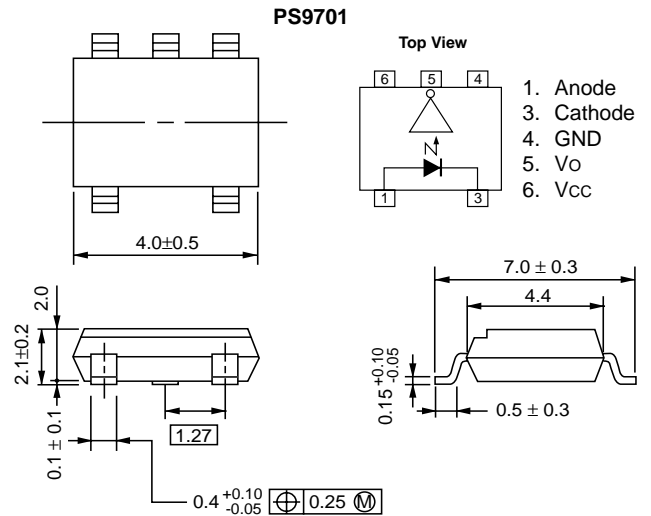

ORDERING INFORMATION

PART NUMBER	PACKAGE	PACKING STYLE	SAFETY STANDARDS APPROVAL
PS9701	5 Pin SOP	Magazine case 100 pcs	UL approved
PS9701-E3		Embossed Tape 900 pcs/reel	
PS9701-E4			
PS9701-F3		Embossed Tape 3500 pcs/reel	
PS9701-F3			
PS9701-V	5 Pin SOP	Magazine case 100 pcs	VDE0884 approved
PS9701-V-E3		Embossed Tape 900 pcs/reel	
PS9701-V-E4			
PS9701-V-F3		Embossed Tape 3500 pcs/reel	
PS9701-V-F4			

TYPICAL PERFORMANCE CURVES (T_A = 25 °C)

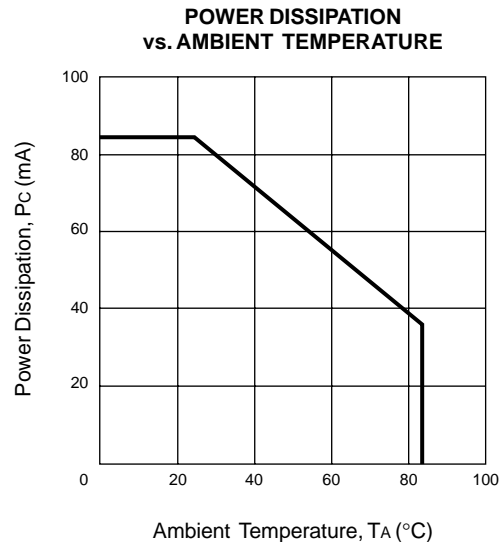
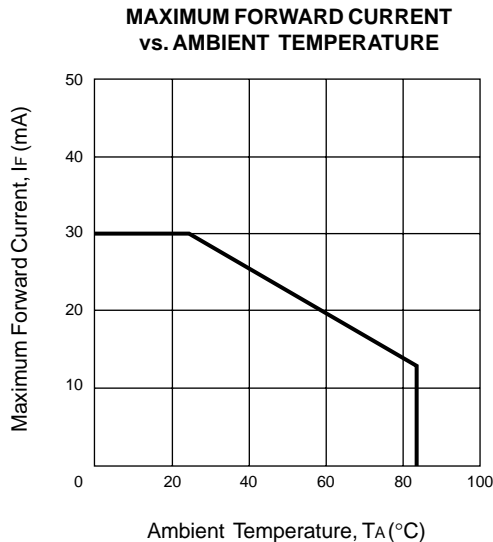

TYPICAL PERFORMANCE CURVES (TA = 25 °C)

FORWARD CURRENT vs. FORWARD VOLTAGE

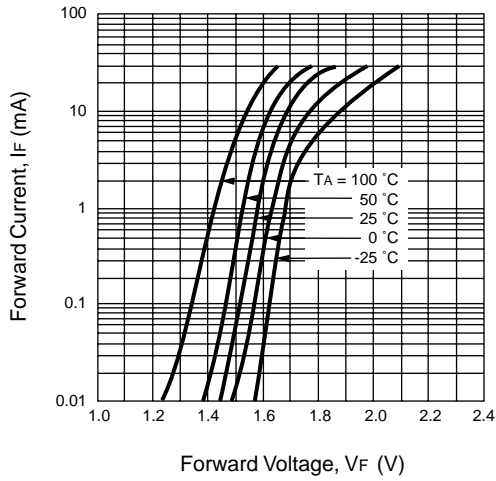

NORMALIZED THRESHOLD INPUT CURRENT vs. AMBIENT TEMPERATURE

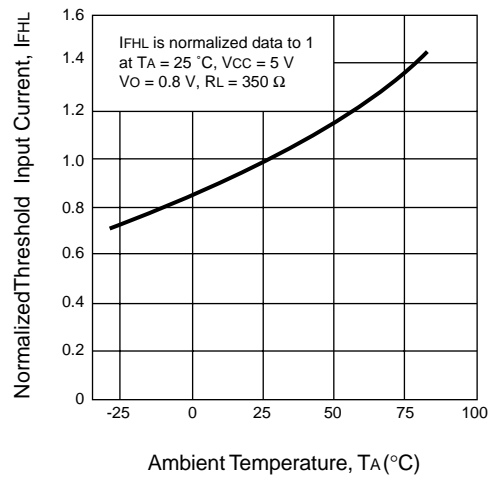

OUTPUT VOLTAGE vs. FORWARD CURRENT

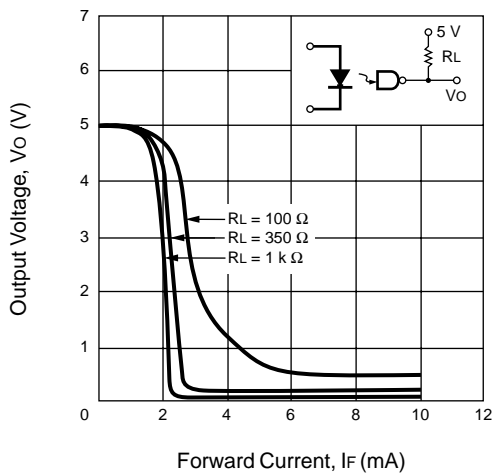

LOW LEVEL OUTPUT VOLTAGE vs. AMBIENT TEMPERATURE

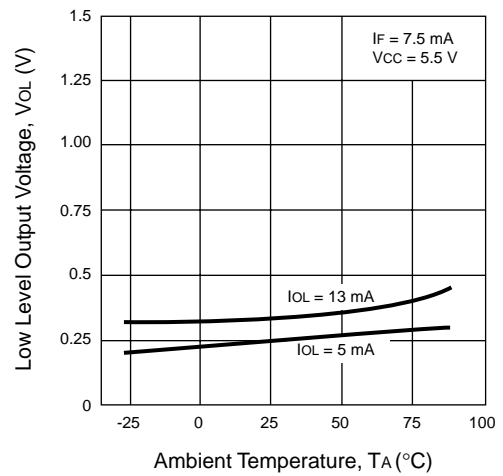

PROPAGATION DELAY TIME vs. FORWARD CURRENT

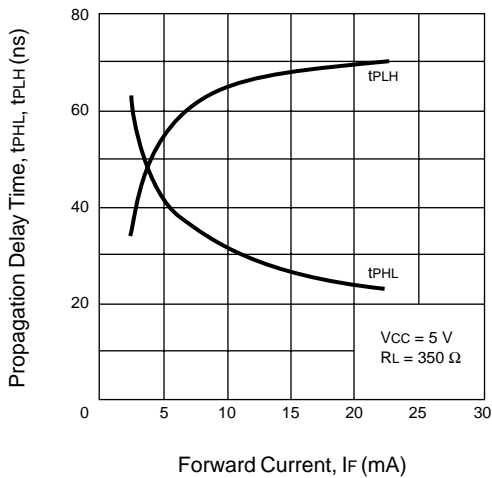

PROPAGATION DELAY TIME vs. LOAD RESISTANCE

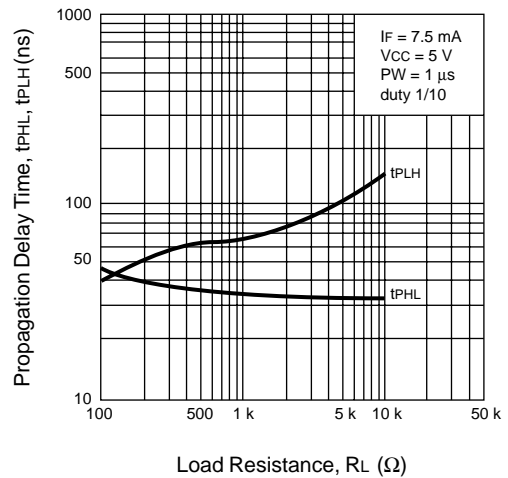

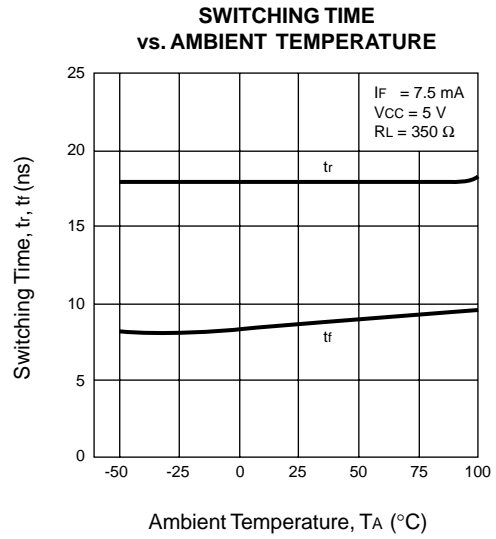
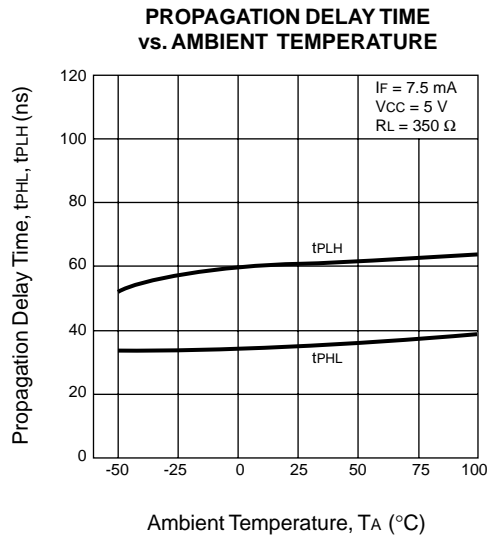
TYPICAL PERFORMANCE CURVES ($T_A = 25^\circ\text{C}$)

TAPING SPECIFICATIONS (Units in mm)

OUTLINE AND DIMENSIONS (TAPE)

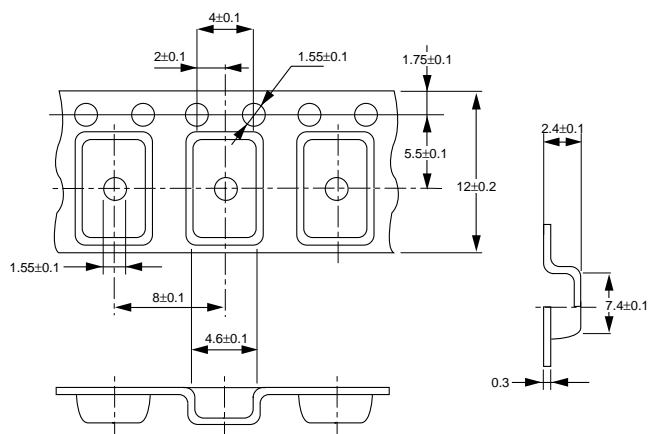

OUTLINE AND DIMENSIONS (REEL)

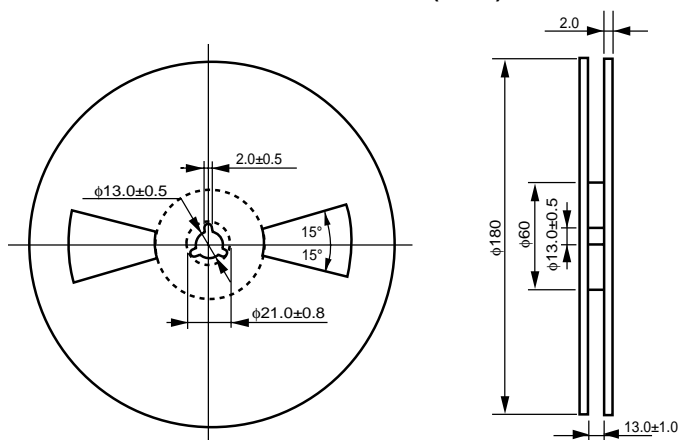

Packing : 900 pcs/reel

TAPE DIRECTION
PS9701-E3

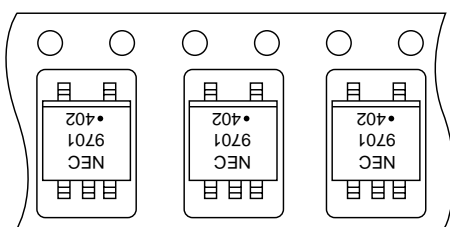

PS9701-E4

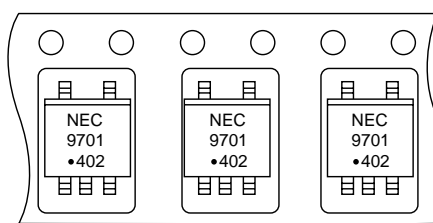

OUTLINE AND DIMENSIONS (TAPE)

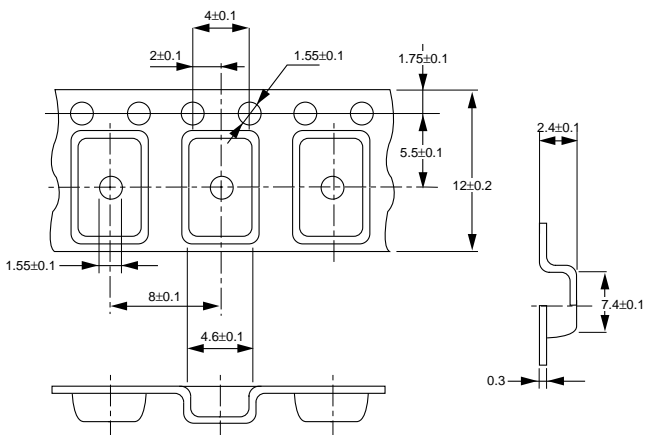

OUTLINE AND DIMENSIONS (REEL)

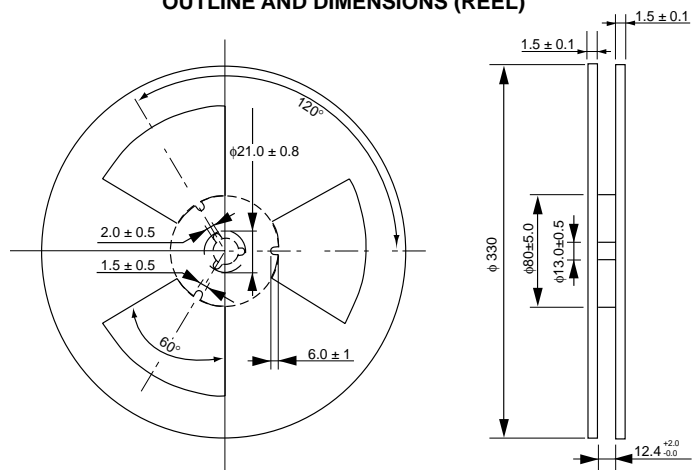

Packing : 3500 pcs/reel

TAPE DIRECTION

PS9701-F3

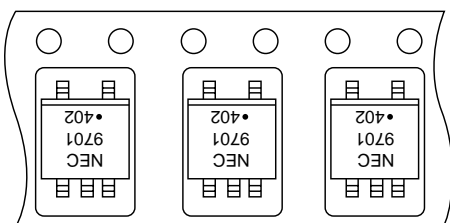

PS9701-F4

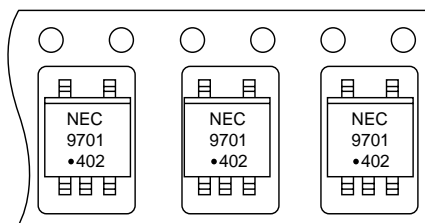

RECOMMENDED SOLDERING CONDITIONS

(1) Infrared reflow soldering

- Peak reflow temperature 235 °C or below (package surface temperature)
- Time of temperature higher than 210 °C 30 seconds or less
- Number of reflows Three
- Flux Rosin flux containing a small amount of chlorine
(The flux with a maximum chlorine content of 0.2 Wt % is recommended)

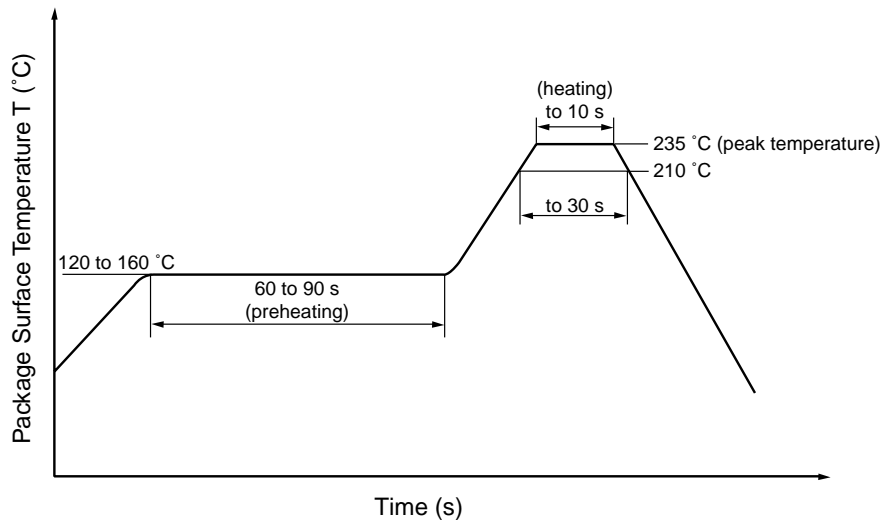

(2) Dip soldering

- Temperature 260 °C or below
- Time 10 seconds or less
- Number of times One
- Flux Rosin flux containing a small amount of chlorine
(The flux with a maximum chlorine content of 0.2 Wt % is recommended.)

(3) Cautions

- Fluxes
Avoid removing the residual flux with freon-based and chlorine-based cleaning solvent.

Life Support Applications

These NEC products are not intended for use in life support devices, appliances, or systems where the malfunction of these products can reasonably be expected to result in personal injury. The customers of CEL using or selling these products for use in such applications do so at their own risk and agree to fully indemnify CEL for all damages resulting from such improper use or sale.

EXCLUSIVE NORTH AMERICAN AGENT FOR **NEC** RF, MICROWAVE & OPTOELECTRONIC SEMICONDUCTORS

CEL CALIFORNIA EASTERN LABORATORIES • Headquarters • 4590 Patrick Henry Drive • Santa Clara, CA 95054-1817 • (408) 988-3500 • Telex 34-6393 • FAX (408) 988-0279
24-Hour Fax-On-Demand: 800-390-3232 (U.S. and Canada only) • Internet: <http://WWW.CEL.COM>

DATA SUBJECT TO CHANGE WITHOUT NOTICE

12/04/2001