



PART NAME

## EXTRUDED ALUMINUM IP65 PCB ENCLOSURES

PART No.

EXN-23355 (SEE TABULATION FOR COMBINATIONS)

REVISION DATE

10-23-15

PART NUMBER	ALUM. COVER	PLASTIC COVER	BODY COLOR
EXN-23355-BK	BLACK	-	BLACK
EXN-23355-BKP	-	BLACK	BLACK
EXN-23355-BL	BLACK	-	BLUE
EXN-23355-BLP	-	TRANSLUCENT BLUE	BLUE
EXN-23355-GD	BLACK	-	GOLD
EXN-23355-GDP	-	CLEAR	GOLD
EXN-23355-RD	BLACK	-	RED
EXN-23355-RDP	-	IR RED	RED
EXN-23355-SV	BLACK	-	SILVER
EXN-23355-SVP	-	CLEAR	SILVER

MATERIAL: ALUMINUM EXTRUSION BODY PROVIDED WITH ALUMINUM COVER (2X) AND GASKETS OR POLYCARBONATE COVER (2X) AND GASKETS - NOT ASSEMBLED

DIMENSIONS ARE INCH[MM]

**DRAWING FOR REFERENCE**  
WE RESERVE THE RIGHT TO MAKE CHANGES TO OUR STANDARD PRODUCTS. PLEASE CONSULT WITH BUD INDUSTRIES PRIOR TO USING THIS DRAWING FOR DESIGN PURPOSE.

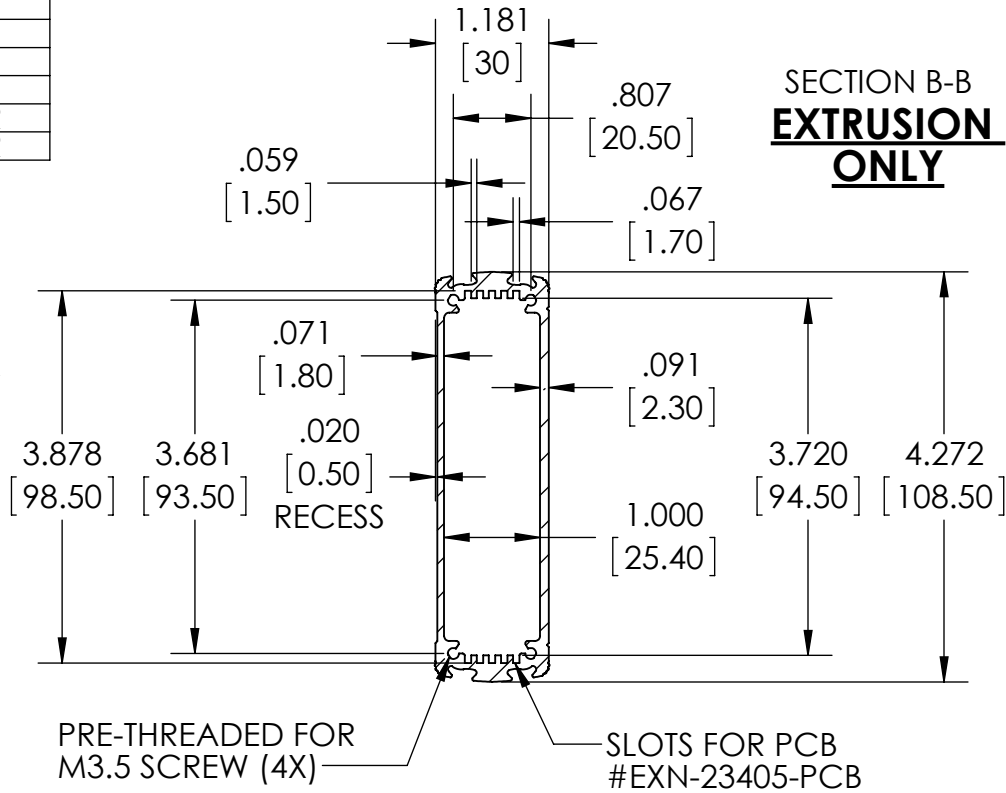
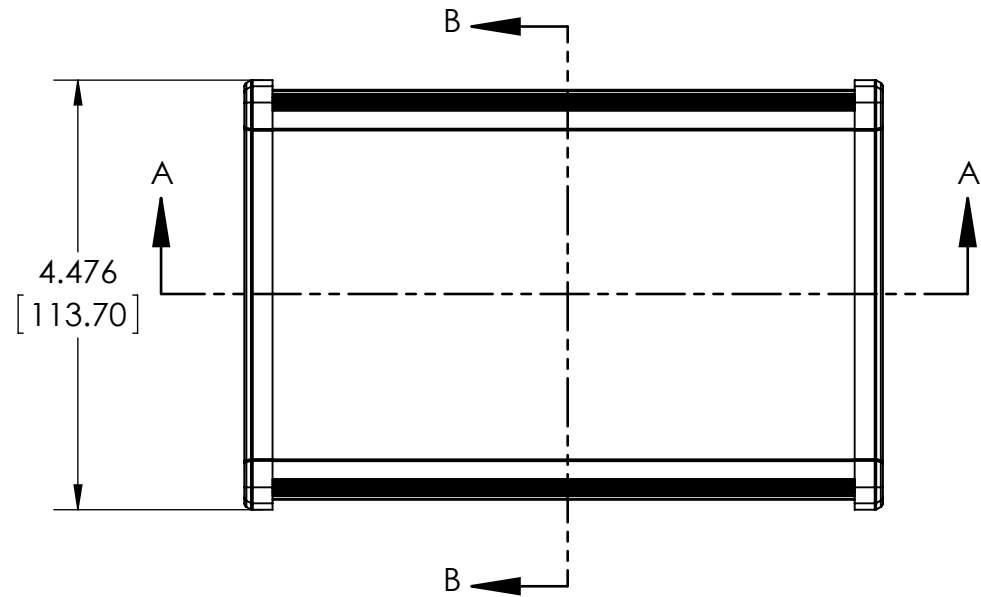
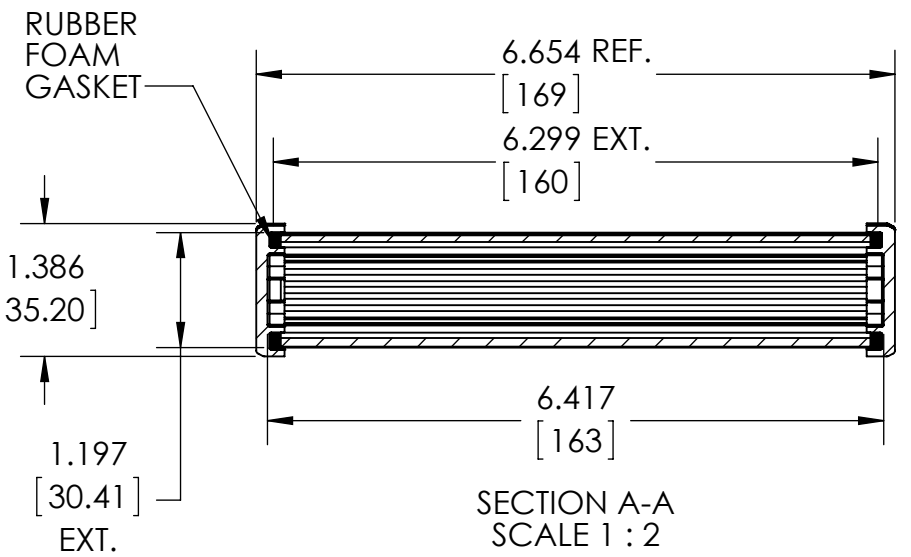
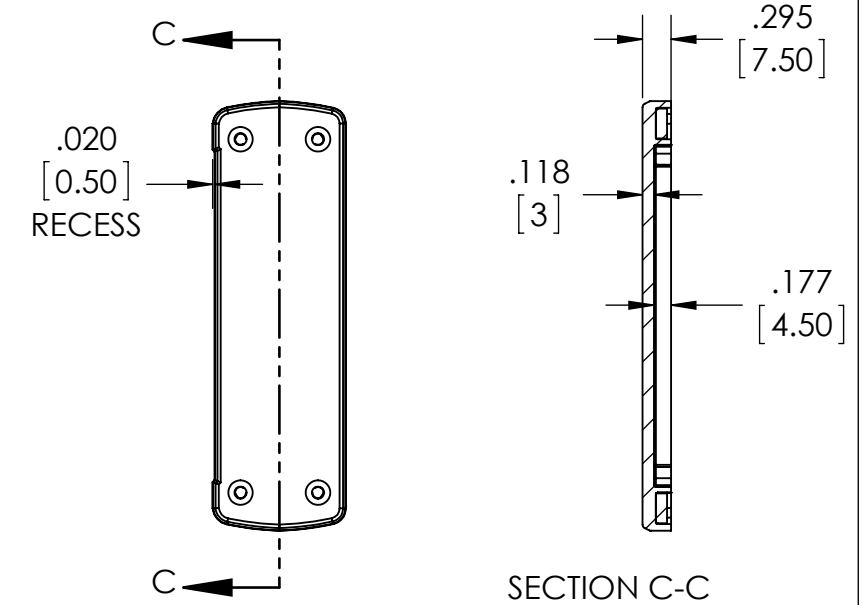
**DIE CAST ALUMINUM COVER**

SECTION A-A  
SCALE 1 : 2  
DIMENSIONS MAY VARY DEPENDING ON THE COMPRESSION OF THE GASKETS

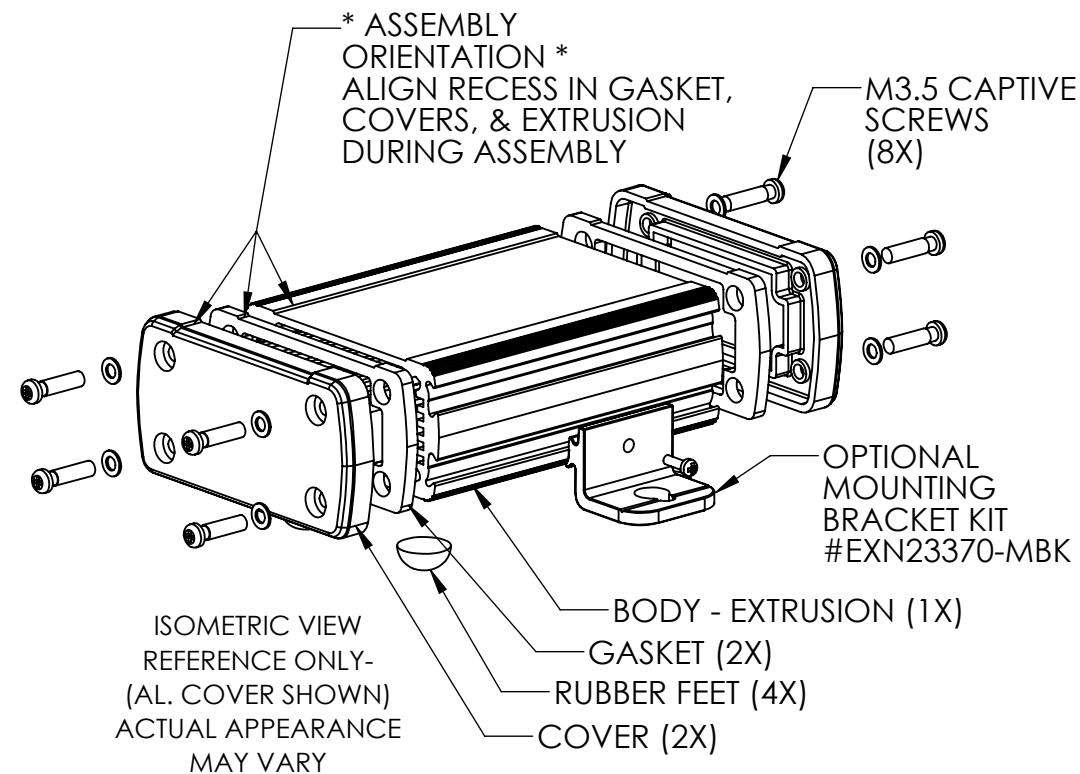
**PLASTIC COVER**