

\* = Mass durch Formkonizität nach unten verringert.  
Freimass - Toleranz nach DIN 16901-140

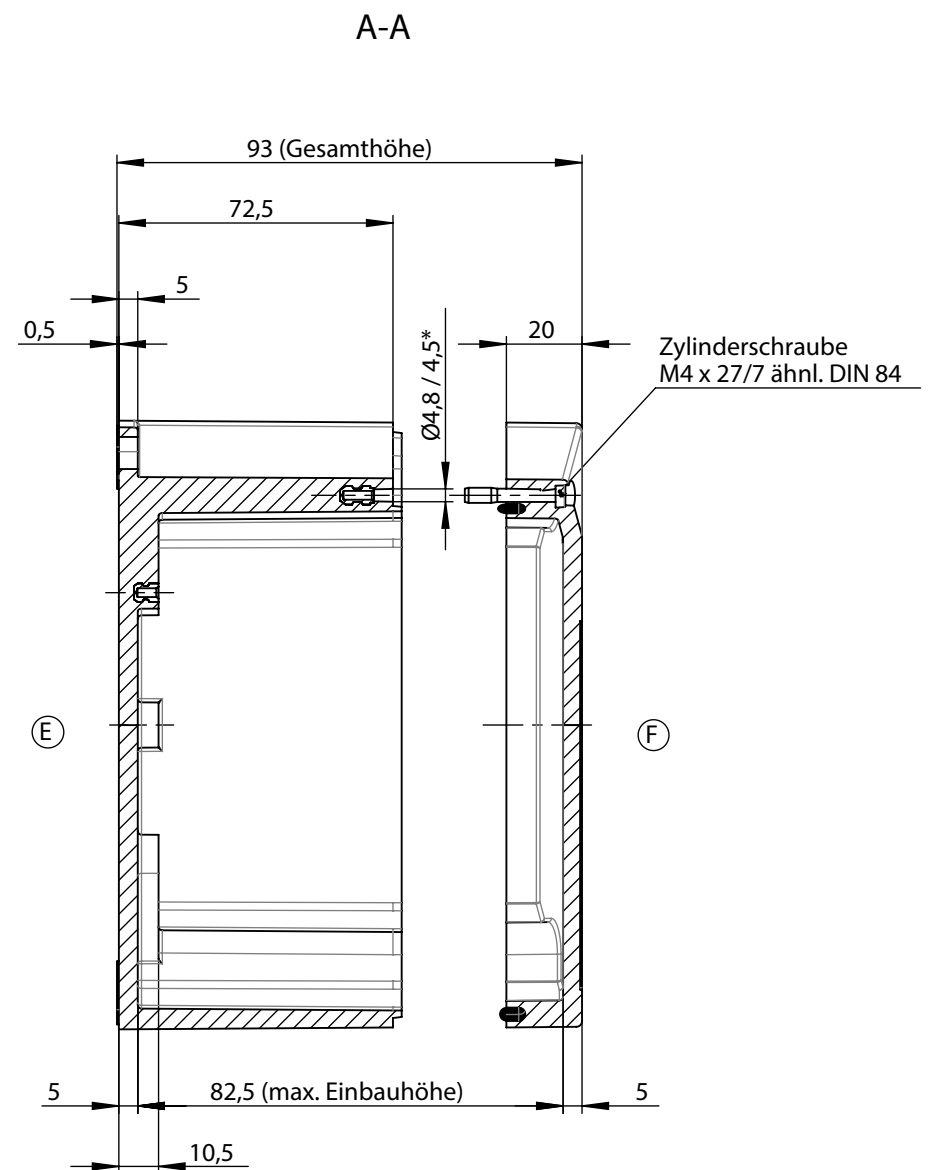
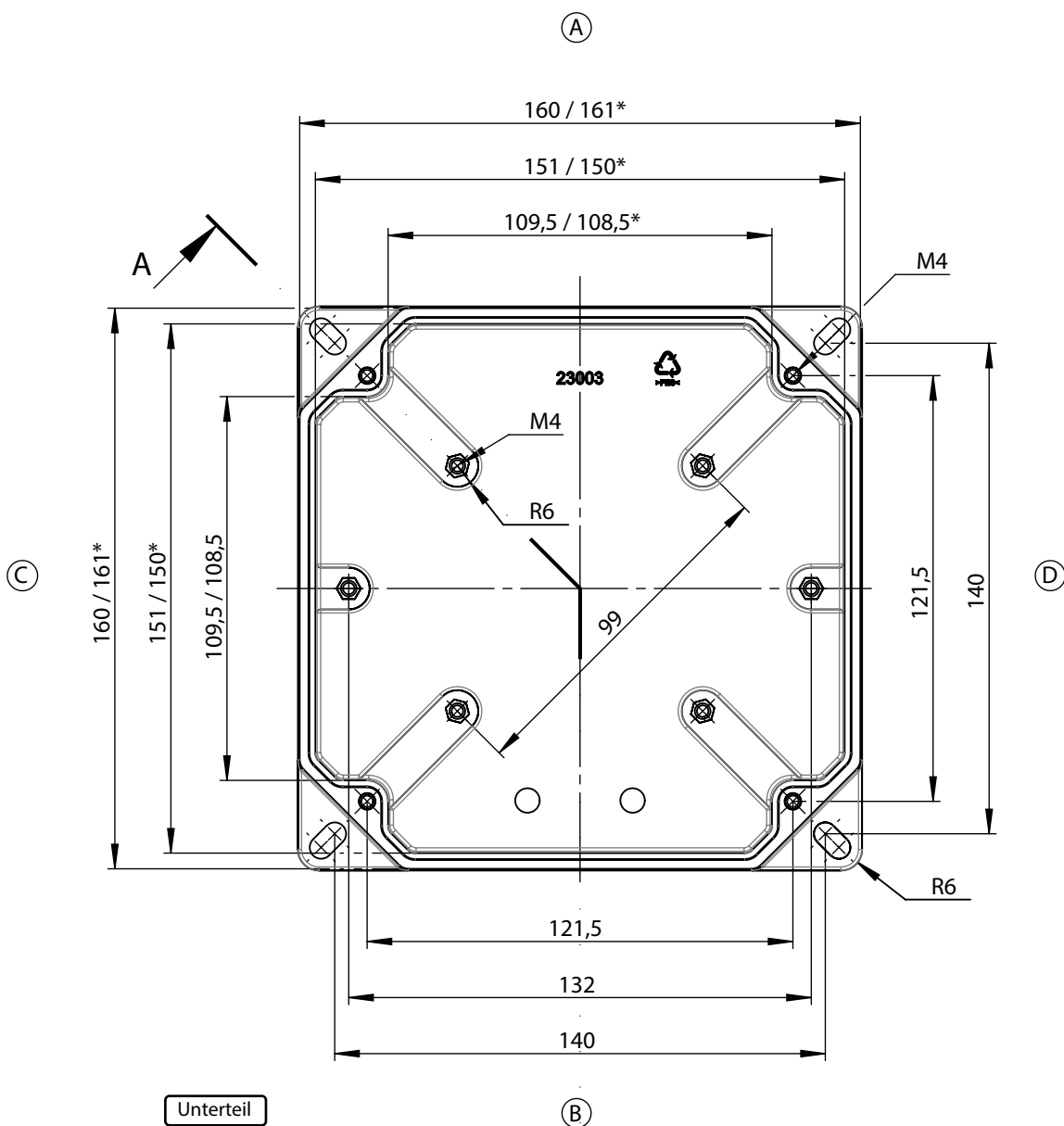

KAT26.880300