

Product data sheet

Specifications



Power relay, Harmony, DIN rail or panel mount, 25A, LED test button, screw terminals, 120V AC, 2NO

725BXXSC3ML-120A

Main

Product range	Harmony Electromechanical Relays
Product type	DIN rail/panel mount relay
[In] rated line current	25 A
Contact composition	2 NO
Contacts material	Silver alloy contacts
Series name	Power
Local signalling	LED indicator test button
Rated power in W	1.3 kW 120 V tungsten
Network frequency	50/60 Hz
Rated power in hp	1 hp at 120 V AC 2 hp at 277 V AC
[Uc] control circuit voltage	120 V
Connections - terminals	Screw clamp terminals

Complementary

Class number	725
Control type	Test button
Maximum switching voltage	240 V conforming to CE 277 V conforming to UL
[Ie] rated operational current	25 A at 277 V AC (on resistive load) conforming to UL 25 A at 240 V AC (general purpose) conforming to UL 25 A at 30 V DC (on resistive load) conforming to UL 25 A at 240 V AC (on resistive load) conforming to IEC 25 A at 28 V DC (on resistive load) conforming to IEC
Coil resistance	5200 Ohm Screw coil terminal M3.5 Screw contact terminal M4
Minimum switching current	100 mA at 5 V DC
Tightening torque	10.6...15 lb.in 1.2...1.7 N.m
Drop-out voltage threshold	AC
Nominal input voltage	102...132 V AC 50/60 Hz
Average coil consumption	2.50 VA
Electrical durability	100000 cycles resistive load conforming to IEC

Mechanical durability	5000000 cycles
Response time	30 ms
Dielectric strength	4000 V AC between coil and contact 2000 V AC between poles
Mounting	DIN rail Flange
Product weight	120 g

Environment

Ambient temperature range - operational	-20...55 °C
Ambient air temperature for storage	-55...100 °C
Product certifications	UL CSA CE
Standards	IEC 60947-1 UL 60947-4-1A
IP degree of protection	IP20
Height	67.7 mm
Width	34.9 mm
Depth	53.9 mm

Packing Units

Unit Type of Package 1	PCE
Number of Units in Package 1	1
Package 1 Height	4.94 cm
Package 1 Width	3.31 cm
Package 1 Length	6.77 cm
Package 1 Weight	120.0 g
Unit Type of Package 2	BB1
Number of Units in Package 2	10
Package 2 Height	7.6 cm
Package 2 Width	14.6 cm
Package 2 Length	31.9 cm
Package 2 Weight	1.2 kg
Unit Type of Package 3	CAR
Number of Units in Package 3	100
Package 3 Height	33.0 cm
Package 3 Width	31.0 cm
Package 3 Length	36.0 cm
Package 3 Weight	12.0 kg

Offer Sustainability

REACH Regulation	REACH Declaration
REACH free of SVHC	Yes
EU RoHS Directive	Pro-active compliance (Product out of EU RoHS legal scope) EU RoHS Declaration

Toxic heavy metal free	Yes
Mercury free	Yes
China RoHS Regulation	China RoHS declaration
RoHS exemption information	Yes
WEEE	The product must be disposed on European Union markets following specific waste collection and never end up in rubbish bins
California proposition 65	WARNING: This product can expose you to chemicals including: Nickel compounds, which is known to the State of California to cause cancer, and Di-isodecyl phthalate (DIDP), which is known to the State of California to cause birth defects or other reproductive harm. For more information go to www.P65Warnings.ca.gov

Dimensions

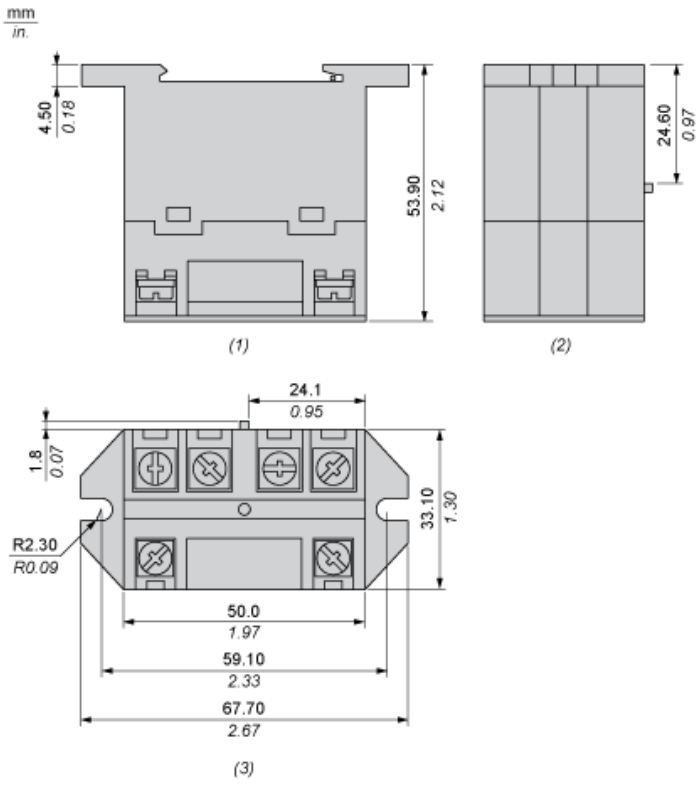

- (1) : Back View
- (2) : Side View
- (3) : Top View

Wiring



Recommended replacement(s)