

General information

Part number	S42F1C-P16MFD0-900S
Termination	solder
Size	2
Locking principle	push
Coding	1_halfshell
Cable Diameter	cable_mini_90
Cable outlet	bend_relief

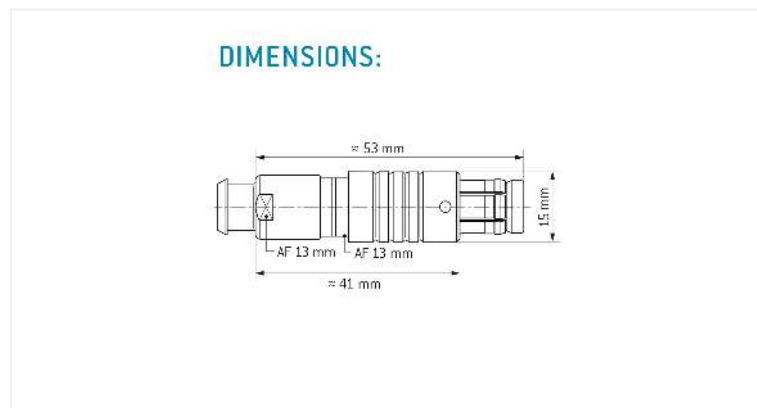

Contact insert description

Number of contacts	16
Contact type	pins
Contact diameter	07mm
Insulator material	peek
Wire cross section	26_awg
Termination	solder
Termination diameter	06mm

reverse_gender_on_request

Technical information

Max. creepage and air clearance distance	08_mm	06_mm
Nominal current single contact	06_a	iec_60512_5_2
Nominal current insert	3 A	vde_0298_4
Test voltage	11_kv_ac	sae_13441

safety_text

Mechanical and environmental data

Degree of protection*	ip68
Operating temperature	40_120_c
Mating cycles	5000

mated

Material and surface treatments

Housing	m_chrome
Contact	cu_alloy_gold

safety_text_2
ul_text
illustrative_text