

Description

The Smart Power Relay E-1048-8C – is a remotely controllable electronic load disconnecting relay with three functions in a single unit:

- electronic relay
- electronic overcurrent protection
- status and monitoring functions

The 7 pin CUBIC version is designed for use with standard automotive relay sockets. A choice of current ratings is available from 1 A through 25 A. An operating voltage range of DC 9...32 V allows the connection of DC 12 V and DC 24 V loads.

In order to switch and protect loads remotely, it has until now been necessary to connect several discreet components together

- an electro-mechanic relay, control cable and integral contact to close the load circuit
- an additional protective element (circuit breaker or fuse) for cable or equipment protection
- a device for current measurement (shunt)

Now type E-1048-8C combines all these functions in a single unit, thus minimising the number of connections in the circuit and thereby reducing the risk of failures.

Applications

Type E-1048-8C is suited to all applications with DC 12 V or DC 24 V circuits, where magnetic valves, motors or lamp loads have to be switched, protected and monitored:

- road vehicles (utility vehicles, buses, special vehicles)
- rail vehicles
- marine industry (ships, boats, yachts etc.)

The Power Relay is also suitable for industrial use (process control, machine-building, engineering) as an electronic coupling relay between PLC and DC 12 V or DC 24 V load

Features

- Integral power electronics provide a wear-resistant switching function, insensitive to shock, vibration and dust.
- Compared to electro-mechanical relays, only a fraction of the closed-circuit current or switching current is needed. This is important for battery buffered load circuits which have to remain controlled even with the generator off line.
- The extremely low induced current consumption of less than 1 mA is absolutely necessary for battery buffered applications.
- The load circuit is disconnected in the event of an overload or short circuit.
- The load circuit is permanently monitored for wire breakage.
- Two status outputs for control signal AS and group signal SF provide status indication. For processing the actual value of the current flow in a power management system an analogue output from 0 to 5 V is provided. This voltage signal may also be used as an input to a control circuit or to switch off the unit by means of external control in the event of low load current value.
- For switching and monitoring loads of 25 A plus it is possible to connect several units in parallel. Uniform power distribution between units must be ensured by symmetrical design of the supply cables (length and cross section).
- Coloured label, for the identification the rated current (e. g. red = 10 A)



E-1048-8C CUBIC version

Technical Data ($T_A = 25^\circ\text{C}$, U_N)

Power supply LINE +

Type	DC power supply with small R_i battery and generator etc.
Voltage ratings U_N	DC 12 V/DC 24 V
Operating voltage U_S :	DC 9...32 V
Closed-circuit current I_0 in the OFF condition	< 1 mA

Load circuit LOAD

Load output	Power MOSFET, high side switching HSS
Current rating range I_N	1 A ... 25 A (fixed rating) without load reduction up to 85° C (1 A...20 A), 25 A bis 60° C ambient temperature $I_N = 1\text{ A} \dots 10\text{ A}$: trip curve 1 $I_N = 15\text{ A} \dots 25\text{ A}$: trip curve 2
Types of loads	resistive, inductive, capacitive, lamp loads, motors (depending on duration of inrush current)

Typical voltage drop U_{ON} at rated current I_N ¹⁾

I_N	U_{ON}	I_N	U_{ON}
1 A	50 mV	10 A	110 mV
2 A	55 mV	15 A	70 mV
3 A	60 mV	20 A	90 mV
5 A	80 mV	25 A	120 mV
7.5 A	90 mV		

Switching point ¹⁾	typically $1.3 \times I_N$ (-40 °C...+85 °C: $1.1 \dots 1.5 \times I_N$)
Trip time ¹⁾	typically 200 ms with switch-on onto overload and/or load increase on duty
max. overload	$I_N = 1\text{ A} \dots 10\text{ A}$: 60 A (at L/R = 3ms) $I_N = 15\text{ A} \dots 25\text{ A}$: 250 A (at L/R = 3ms)
Temperature disconnection	power transistor > 150 °C
Parallel connection of channels	for loads of 25 A plus, several units of identical current ratings may be connected in parallel. To ensure equal distribution of current between units, symmetrical design of the supply feed is necessary (length and cross section).

Free-wheeling diode for connected load	integral $I_N = 1\text{ A} \dots 10\text{ A}$: 40 A $I_N = 15\text{ A} \dots 25\text{ A}$: 100 A
Delay time ¹⁾	t_{on} 5 ms / t_{off} 1.5 ms

¹⁾ typical

Technical Data ($T_A = 25\text{ °C}$, $U_N = \text{DC } 24\text{ V}$) (T_A = ambient temperature at U_N)

Wire breakage monitoring in ON and OFF condition of load ¹⁾ wire breakage thresholds:
 in OFF-condition (ver.1): $R_{load} > 100\text{ k}\Omega$
 in OFF-condition (ver.2): $R_{load} > 10\text{ k}\Omega$
 in ON-condition: $I_{load} < 0.2 \times I_N$
 indication via group fault signalisation SF (switching output)
 Fault indication will not be stored, i.e. after remedy of wire breakage fault indication will disappear
 Possible options:
 - wire breakage indication only in ON condition
 - wire breakage indication only in OFF condition
 - no wire breakage indication)
 - disconnection of load, indication via group signal SF
 - no automatic re-start
 - after remedy of the fault unit has to be reset via control input IN+

Short circuit, overload in load circuit

Control input IN+

Control voltage I_{IN+} 0...5 V = "OFF", 8.5...32 V = "ON"
 Control current I_E 1...10 mA (8.5...DC 32 V)
 Reset in the event of a failure - via external control signal (low-high) at control input IN+
 - high) at control input IN+
 - via reset of supply voltage

Switching frequency at resistive or inductive load max. 60 Hz
 Edge of IN < 5 ms

Status and diagnostic functions

Control signal AS transistor output low side switching (LSS), open collector, short circuit and overload proof, max. load: DC 32 V/2 A
 0 V-level: when unit is set (at $I_{IN+} = 8.4...32\text{ V}$)

Group signal SF transistor output low side switching (LSS), open collector, short circuit and overload proof, load max. DC 32 V/2 A
 0 V-level with overload and short circuit disconnection, wire breakage indication

Analogue output U(I) voltage output 0-5 V proportional to load current:
 $1\text{ V} = 0.2 \times I_N$
 $5\text{ V} = 1.0 \times I_N$
 5 V... typically 6.5 V = overload range
 tolerance: (for $I_{load} > 0.2 \times I_N$) $\pm 8\%$ of I_N
 max. output current 5 mA
 load resistance > 1 k Ω against GND
 response time when switching on a load: $t_{90} = 20\text{ ms}$
 response time of load change on duty: $t_{90} = 1\text{ ms}$

Visual status indication
 control signal AS LED yellow
 group fault signal SF LED red

General data

Reverse polarity protection
 Control circuit yes
 Load circuit no (due to integral free-wheeling diode)
 Status outputs interference voltage resistance max. DC 32 V

¹⁾ typically

Technical Data ($T_A = 25\text{ °C}$, $U_N = \text{DC } 24\text{ V}$) (T_A = ambient temperature at U_N)

Temperature range 1...20 A: -40...+85 °C
 ambient temperature 25 A: -40...+60 °C without load reduction
 Temperature shutdown power transistor > 150 °C

Tests

Humid heat combined test, 9 cycles with functional test
 test to DIN EN 60068-2-30, Z/AD

Temperature change min. temperature -40 °C, max. temperature +90 °C
 test to DIN IEC 60068-2-14, Nb in operation, with temperature change 6 g eff. (10 Hz...2,000 Hz)
 test to DIN EN 60068-2-64
 Vibration was tested with standard sockets for PCB mounting.
 Behaviour at vibrations depends on design, quality and age (number of push-in cycles) of the socket particularly regarding duration of the vibration and the mounting position

Vibration (random) 25 g/11 ms, 10 shocks
 test to DIN EN 60068-2-27

Shock 25 g/11 ms, 10 shocks
 test to DIN EN 60068-2-27

Corrosion test to DIN EN 60068-2-52, severity 3

Protection class housing -8C4 IP30 to DIN 40050
 housing -8C5 IP54 to DIN 40050, higher protection class upon request

EMC requirements EMC directive:
 emitted interference EN 50081-1
 noise immunity EN 61000-6-2
 Automotive directive:
 emitted interference, noise immunity: 72/245/EWG und 2006/28/EG

Terminals of CUBIC version (7 pin, standard)

5 blade terminals 6.3 mm x 0.8 mm and 2 blade terminals 2.8 mm x 0.6 mm to DIN 46244
 Contact material CuZn37F44
 on automotive relay socket 4-pole or 7-pole

Housing CUBIC version

max. dimensions 30 x 30 x 40 mm when plugged in
 30 x 30 x 51.6 mm including terminals
 housing PA66-GF30
 Materials base plate PA6-GF30
 Mass approx. 23 g...43 g, depending on version

Approvals

CE, E1 logo to EMC directive and vehicles directive
 Approved by Kraftfahrt-Bundesamt
 approvals no. E1 10R-043880



Ordering Information

Type

E-1048-8C Smart Power Relay DC 12 V/24 V - 1 A...25 A in CUBIC version

Housing / temperature range

- 4** with housing -40 °C...85 °C (60 °C at I_N = 25 A)
- 5** with housing -40 °C...85 °C (60 °C at I_N = 25 A) increased environmental requirements (IP protection class etc.)

Control input

- C** with control input (+ control 8.5...32 V)

LEDs

- 0** without
- 3** 2 LEDs: AS yellow, SF red

Status output minus-switching

- A** without
- D** with AS and SF

Contents of group fault signal SF/ LED indication SF

- 0** without
- 1** short circuit / overload
- 4** short circuit / overload + wire breakage

Analogue output

- V0** without
- V1** 0...5 V

Characteristic curve

- 4** 200 ms standard switch-off delay with overload)

Voltage rating

- U3** DC 12/24 V

Current ratings / colour of label

- 1 A / black**
- 2 A / grey**
- 3 A / purple**
- 5 A / light-brown**
- 7.5 A / brown**
- 10 A / red**
- 15 A / blue**
- 20 A / yellows**
- 25 A / white**

E-1048-8C 4 - C 3 D 4 V1 - 4 U3 - 20 A

ordering example 1: 7 pole version

E-1048-8C 4 - C 0 A 0 V0 - 4 U3 - 5 A

ordering example 2: 4 pole version

Preferred types

Preferred types	Standard current ratings (A)					
	5	7.5	10	15	20	25
E-1048-8C4-C3A1V0-4U3-	x	x	x	x	x	x

Approvals

Authority	Approval mark	Regulation
KBA	E1	ECE R 10

Dimensions „DELUXE“ version (7 pin version)

with all options: - LED indications AS/SF
- status outputs AS/SF
- analogue output U (I)

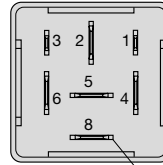

2, 4, 5, 6 and 8 - blade terminals 6.3 x 0.8
1 and 3 - blade terminals 2.8 x 0.6

footprint to ISO 7588

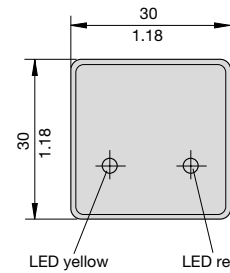
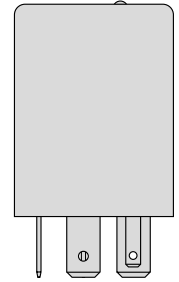
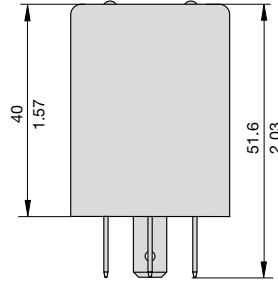

Dimensions „BASIC Version“ (4 pin version)

without options: - LED indication AS/SF
- status outputs AS/SF
- analogue output U (I)

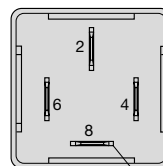

2, 4, 6 and 8 - blade terminals 6.3 x 0.8

footprint to ISO 7588

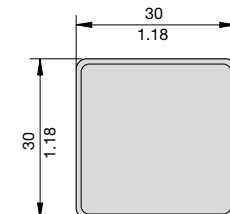
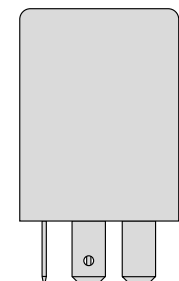
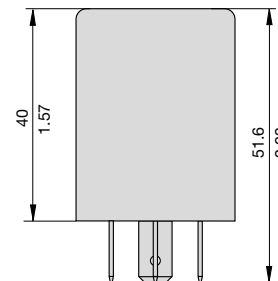

This is a metric design and millimeter dimensions take precedence (mm/inch)

5

Typical time/current characteristics ($T_U = 25\text{ }^\circ\text{C}$)

Trip curve 1:
1 A, 2 A, 3 A, 5 A, 7 1/2 A and 10 A (standard 200 ms)

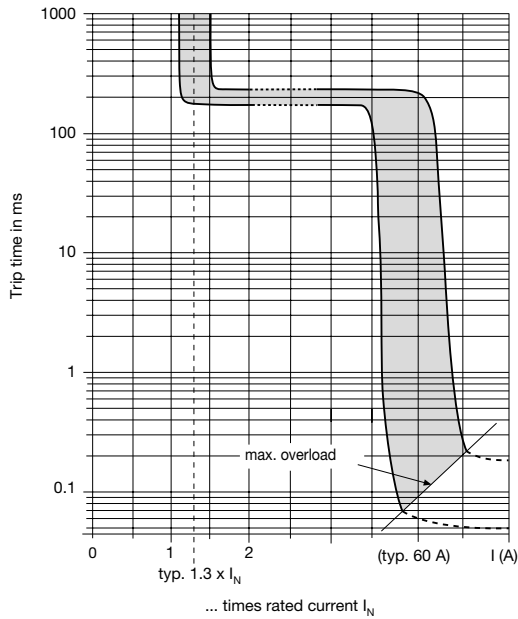

Trip curve 2: 15 A, 20 A and 25 A (standard 200 ms)

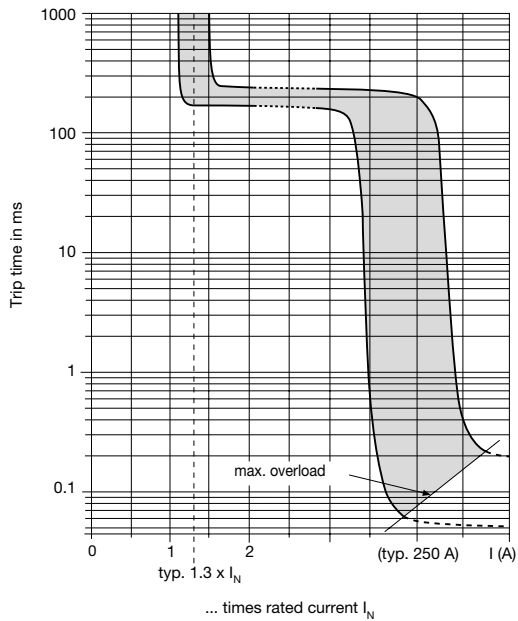

Connection diagram

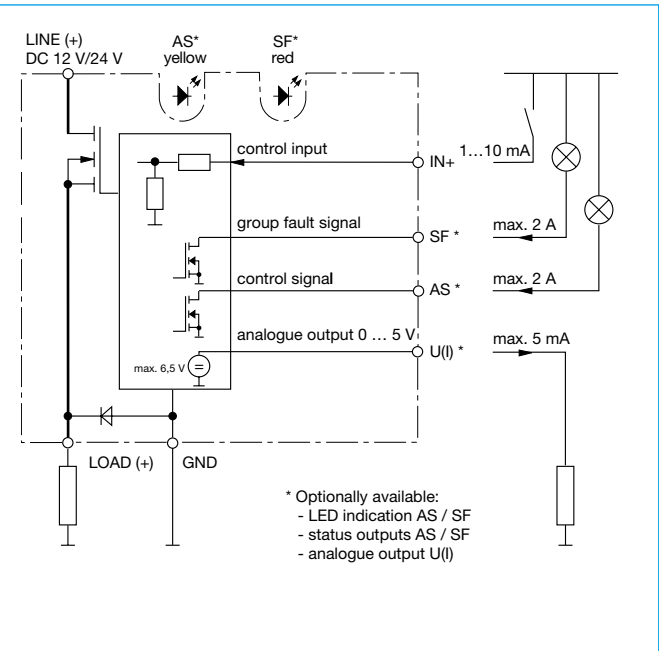

Pin selection CUBIC version (7 pin = "DELUXE")

E-1048-8C CUBIC version

AS	1	control signal ($\hat{=}$ LED yellow)
LINE +	2 (30)	plus U_S (DC 12 V/24 V)
SF	3	group fault signal ($\hat{=}$ LED red)
IN+	4 (86)	control input
U(I)	5	0...5 V analogue output
GND	6 (31)	minus U_S
LOAD	8 (88a)	load output

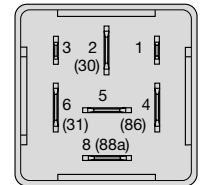

($\hat{=}$) $\hat{=}$ automotive terminal labeling

Pin selection CUBIC version (4 pin = "BASIC")

E-1048-8C CUBIC version

LINE +	1	
	2 (30)	plus U_S (DC 12 V/24 V)
	3	
IN+	4 (86)	control input
	5	
GND	6 (31)	minus U_S
LOAD	8 (88a)	load output

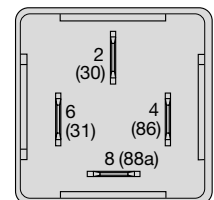

($\hat{=}$) $\hat{=}$ automotive terminal labeling

All dimensions without tolerances are for reference only. In the interest of improved design, performance and cost effectiveness the right to make changes in these specifications without notice is reserved. Product markings may not be exactly as the ordering codes. Errors and omissions excepted.

5