

PNA4602M

Photodiode with Photodetection Function

For infrared remote control systems

■ Features

- Extension distance: 8 m or more
- External parts not required
- Adoption of visible light cutoff resin

■ Absolute Maximum Ratings $T_a = 25^\circ\text{C}$

Parameter	Symbol	Rating	Unit
Operating supply voltage	V_{CC}	-0.5 to +7	V
Power dissipation	P_D	200	mW
Operating ambient temperature	T_{opr}	-20 to +75	$^\circ\text{C}$
Storage temperature	T_{stg}	-40 to +100	$^\circ\text{C}$
Soldering temperature *	T_{sol}	260	$^\circ\text{C}$

Note) *: Less than 5 s

■ Electrical-Optical Characteristics $T_a = 25^\circ\text{C} \pm 3^\circ\text{C}$

Parameter	Symbol	Conditions	Min	Typ	Max	Unit
Operating supply voltage	V_{CC}		4.7	5.0	5.3	V
Supply current	I_{CC}	No signal condition	1.8	2.4	3.0	mA
Maximum reception distance *1	L_{max}		8.0	10.0		m
Low level output voltage *2	V_{OL}	$L \leq 8.0 \text{ m}, I_{OL} = 400 \mu\text{A}$		0.35	0.5	V
High level output voltage	V_{OH}	No signal condition, $I_{OH} = -10 \mu\text{A}$	4.75	4.8		V
Low level pulse width *1	T_{WL}	$L = 0.1 \text{ m to } 8.0 \text{ m}, 16 \text{ pulse}$	200	400	600	μs
High level pulse width *1	T_{WH}	$L = 0.1 \text{ m to } 8.0 \text{ m}, 16 \text{ pulse}$	200	400	600	μs
Center frequency	f_O			38.0		kHz
Load resistance	R_L		15	20	25	$\text{k}\Omega$

Note) 1. Measuring methods are based on JAPANESE INDUSTRIAL STANDARD JIS C 7031 measuring methods for diodes.

2. *1: Burst wave form figure 1.

*2: Constant wave form Figure 2.

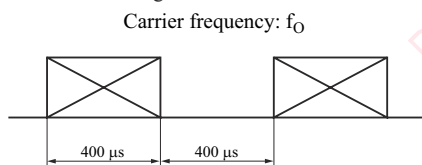

Figure 1

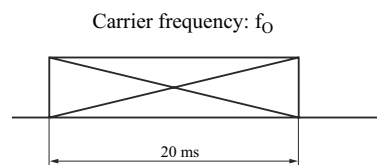
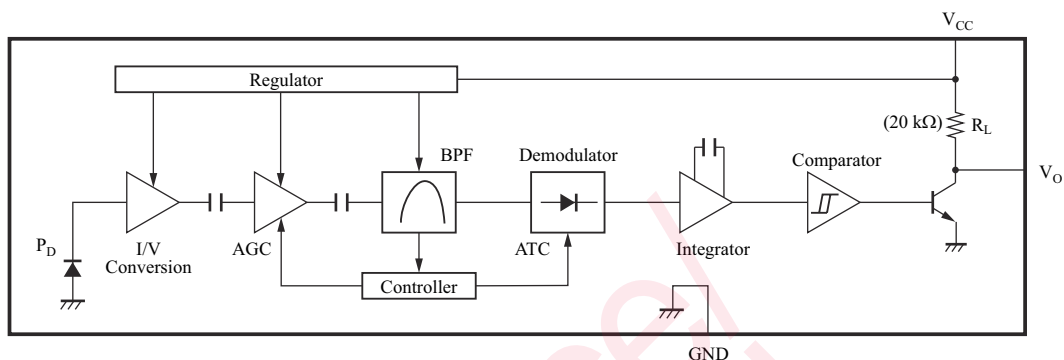
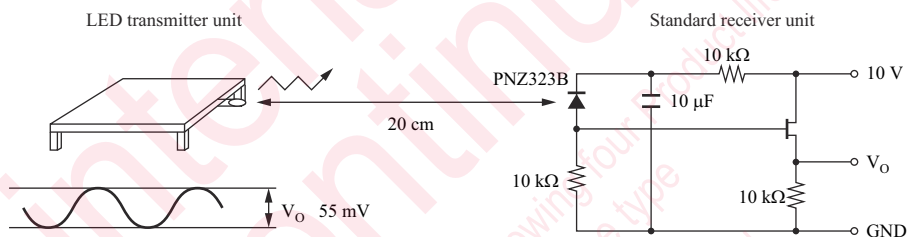

Figure 2

■ Block Diagram



■ Panasonic Transmitter Specifications



1. The output of the LED transmitter unit is adjusted so that the output standard receiver unit, V_O may be 55 mV when transmitting waves (duty = 50%) are output from the transmitter unit, where the sensitivity to infrared emitters (SIR) of PNZ323B is $0.53 \mu\text{A}$ when the irradiance H is $12.45 \mu\text{W}/\text{cm}^2$.
2. The maximum detection distance of this specification is guaranteed by T_{WH} and T_{WL} being within the limits when constant 16 pulses are transmitted with the output of the transmitter unit corresponded to the maximum detection distance in the system above. (The maximum detection distance is measured in the darkness without disturbing noises.)

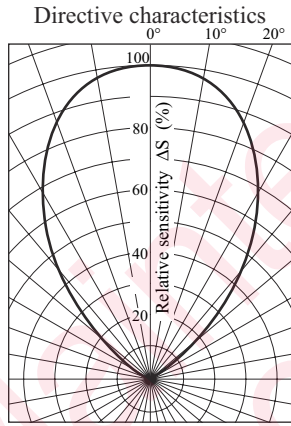
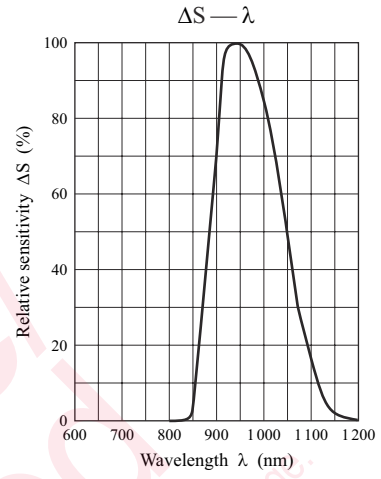
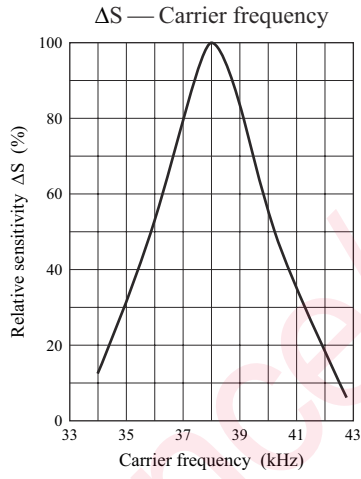
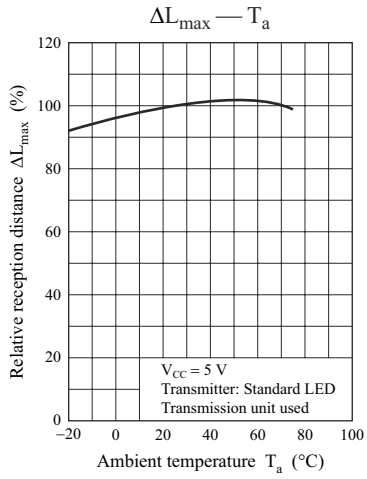

Request for your special attention and precautions in using the technical information and semiconductors described in this book

- (1) If any of the products or technical information described in this book is to be exported or provided to non-residents, the laws and regulations of the exporting country, especially, those with regard to security export control, must be observed.
- (2) The technical information described in this book is intended only to show the main characteristics and application circuit examples of the products. No license is granted in and to any intellectual property right or other right owned by Panasonic Corporation or any other company. Therefore, no responsibility is assumed by our company as to the infringement upon any such right owned by any other company which may arise as a result of the use of technical information described in this book.
- (3) The products described in this book are intended to be used for standard applications or general electronic equipment (such as office equipment, communications equipment, measuring instruments and household appliances).
Consult our sales staff in advance for information on the following applications:
 - Special applications (such as for airplanes, aerospace, automobiles, traffic control equipment, combustion equipment, life support systems and safety devices) in which exceptional quality and reliability are required, or if the failure or malfunction of the products may directly jeopardize life or harm the human body.
 - Any applications other than the standard applications intended.
- (4) The products and product specifications described in this book are subject to change without notice for modification and/or improvement. At the final stage of your design, purchasing, or use of the products, therefore, ask for the most up-to-date Product Standards in advance to make sure that the latest specifications satisfy your requirements.
- (5) When designing your equipment, comply with the range of absolute maximum rating and the guaranteed operating conditions (operating power supply voltage and operating environment etc.). Especially, please be careful not to exceed the range of absolute maximum rating on the transient state, such as power-on, power-off and mode-switching. Otherwise, we will not be liable for any defect which may arise later in your equipment.
Even when the products are used within the guaranteed values, take into the consideration of incidence of break down and failure mode, possible to occur to semiconductor products. Measures on the systems such as redundant design, arresting the spread of fire or preventing glitch are recommended in order to prevent physical injury, fire, social damages, for example, by using the products.
- (6) Comply with the instructions for use in order to prevent breakdown and characteristics change due to external factors (ESD, EOS, thermal stress and mechanical stress) at the time of handling, mounting or at customer's process. When using products for which damp-proof packing is required, satisfy the conditions, such as shelf life and the elapsed time since first opening the packages.
- (7) This book may be not reprinted or reproduced whether wholly or partially, without the prior written permission of our company.