

Small Signal Product

High Speed SMD Switching Diode

FEATURES

- Fast switching device ($t_{rr} < 4.0\text{ns}$)
- Surface device type mounting
- Matte Tin(Sn) terminal finish
- Pb free version and RoHS compliant



MECHANICAL DATA

- Case: Mini-MELF Package
- High temperature soldering guaranteed: $270^{\circ}\text{C}/10\text{s}$
- Polarity: Indicated by black cathode band
- Weight: 31mg (approximately)

MINI MELF

Hermetically Sealed Glass



MAXIMUM RATINGS AND ELECTRICAL CHARACTERISTICS ($T_A=25^{\circ}\text{C}$ unless otherwise noted)			
PARAMETER	SYMBOL	VALUE	UNIT
Power Dissipation	P_D	500	mW
Repetitive Peak Reverse Voltage	V_{RRM}	75	V
Reverse Voltage	V_R	75	V
Peak Forward Surge Current (Note 1)	I_{FSM}	2	A
Non-Repetitive Peak Forward Current	I_{FM}	450	mA
Mean Forward Current	$I_{F(AV)}$	150	mA
Forward Continuous Current	I_F	150	mA
Repetitive Peak Forward Current	I_{FRM}	450	mA
Thermal Resistance (Junction to Ambient) (Note 2)	$R_{\theta JA}$	300	$^{\circ}\text{C}/\text{W}$
Junction and Storage Temperature Range	T_J, T_{STG}	-65 to +175	$^{\circ}\text{C}$

PARAMETER	SYMBOL	MIN	MAX	UNIT		
Reverse Breakdown Voltage	$V_{(BR)}$	$I_R=100\mu\text{A}$	100	-	V	
		$I_R=5\mu\text{A}$	75	-		
Forward Voltage	V_F	-	-	V		
		LL4448, LL914B	$I_F=5\text{ mA}$		0.62	0.72
		LL4148	$I_F=50\text{ mA}$		-	1
		LL4448, LL914B	$I_F=100\text{ mA}$		-	1
Reverse Leakage Current	I_R	$V_R=20\text{V}$	-	25	nA	
		$V_R=75\text{V}$	-	5	μA	
Junction Capacitance	C_J	$V_R=0$ $f=1.0\text{MHz}$	-	4	pF	
Reverse Recovery Time	t_{rr}	(Note 3)	-	4	ns	

Note 1: Test condition : 8.3 ms single half sine-wave superimposed on rated load (JEDEC method)

Note 2: Valid provided that electrodes are kept at ambient temperature

 Note 3: Reverse recovery test conditions : $I_F=I_R=10\text{mA}$, $R_L=100\Omega$, $I_{RR}=1\text{mA}$

Small Signal Product

RATINGS AND CHARACTERISTICS CURVES

($T_A=25^\circ\text{C}$ unless otherwise noted)

Fig. 1 Typical Forward Characteristics

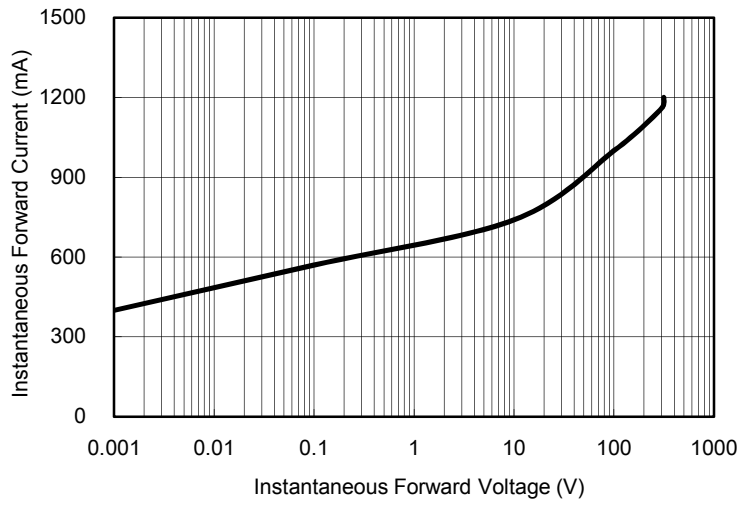

Fig. 2 Reverse Current VS. Reverse Voltage

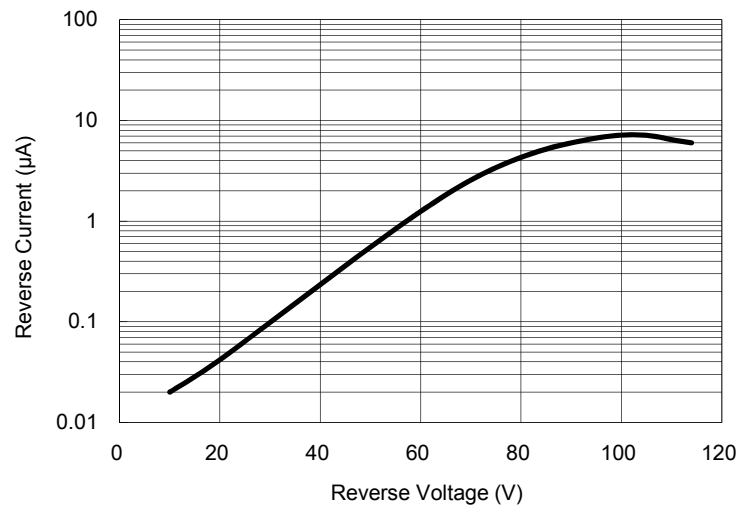

Fig. 3 Admissible Power Dissipation Curve

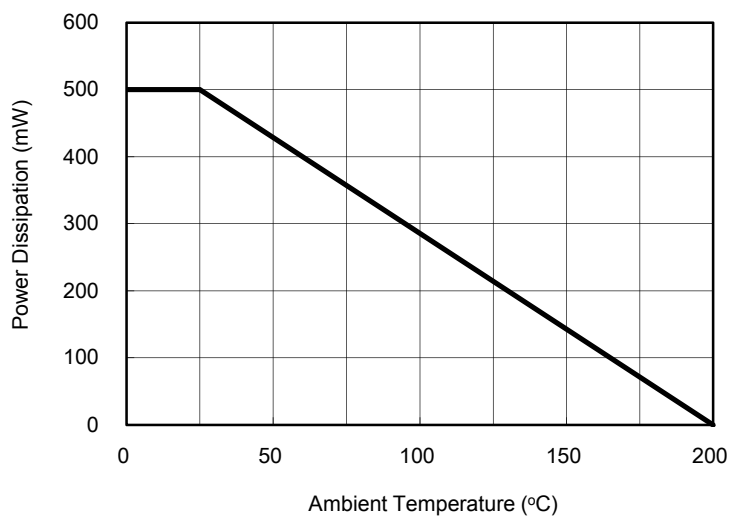

Fig. 4 Typical Junction Capacitance

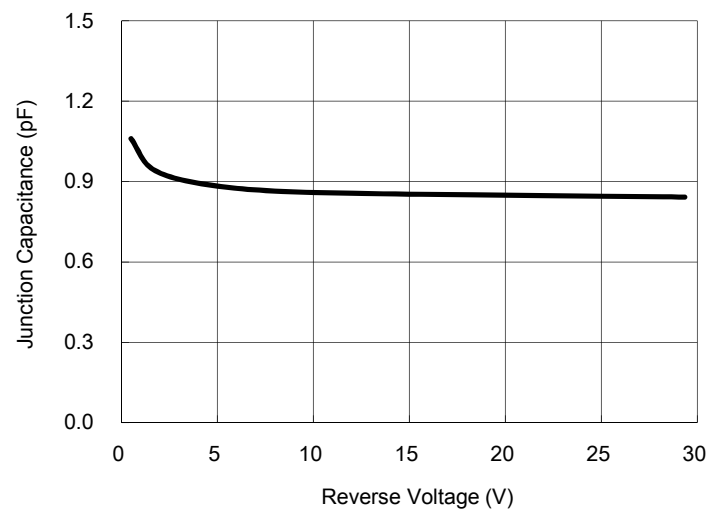
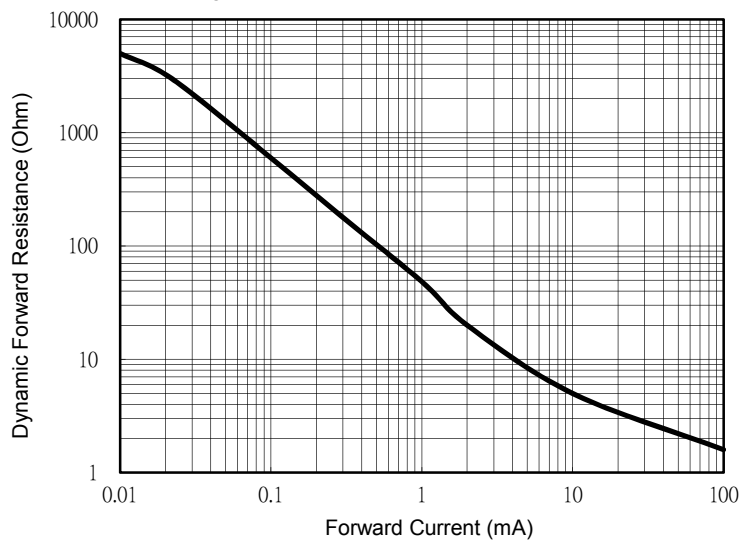

Fig. 5 Forward Resistance VS. Forward Current



Small Signal Product

ORDER INFORMATION (EXAMPLE)

LL4148 LOG

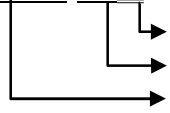

Green compound code
Packing code
Part no.

PACKAGE OUTLINE DIMENSION

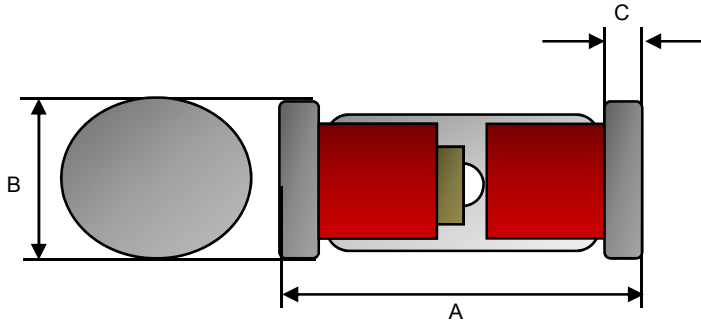

DIM.	Unit (mm)		Unit (inch)	
	Min	Max	Min	Max
A	3.30	3.70	0.130	0.146
B	1.40	1.60	0.055	0.063
C	0.20	0.50	0.008	0.020

SUGGEST PAD LAYOUT

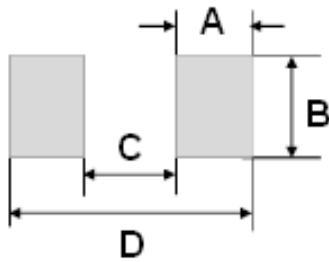

DIM.	Unit (mm)	Unit (inch)
	Typ.	Typ.
A	1.25	0.049
B	2.00	0.079
C	2.50	0.098
D	5.00	0.197

Notice

Specifications of the products displayed herein are subject to change without notice. TSC or anyone on its behalf, assumes no responsibility or liability for any errors or inaccuracies.

Information contained herein is intended to provide a product description only. No license, express or implied, to any intellectual property rights is granted by this document. Except as provided in TSC's terms and conditions of sale for such products, TSC assumes no liability whatsoever, and disclaims any express or implied warranty, relating to sale and/or use of TSC products including liability or warranties relating to fitness for a particular purpose, merchantability, or infringement of any patent, copyright, or other intellectual property right.

The products shown herein are not designed for use in medical, life-saving, or life-sustaining applications. Customers using or selling these products for use in such applications do so at their own risk and agree to fully indemnify TSC for any damages resulting from such improper use or sale.