



COILTRONICS
INCORPORATED



THIN-PAC

THIN-PAC™

GENERAL

THIN-PACs are extremely thin, highly efficient surface mount inductors specifically designed for applications where physical size, especially component height, is critical. With heights as low as 1.8 mm, THIN-PACs offer circuit design engineers a choice of very powerful inductors in very small and thin packages.

THIN-PACs deliver inductance values from 0.47 to 47.0 μ H with current ranges from 0.59 to 2.8 Amps. They are manufactured using toroidal cores for low EMI, high Q, and high efficiency. The devices incorporate advanced technology materials and processes resulting in the highest possible power density in the thinnest possible case.

THIN-PACs provide circuit design engineers the highest performance to height ratio of any SMT inductors. Their ideal applications include DC-DC converters, PC cards, disk drives, and small-scale power supplies.

THIN-PACs are packaged on standard 13" reels to facilitate pick-and-place assembly. Their rugged construction permits normal exposure to infrared reflow soldering to +240°C.

In addition to the standard inductance values shown, modified THIN-PAC inductors are available to meet your high volume requirements.

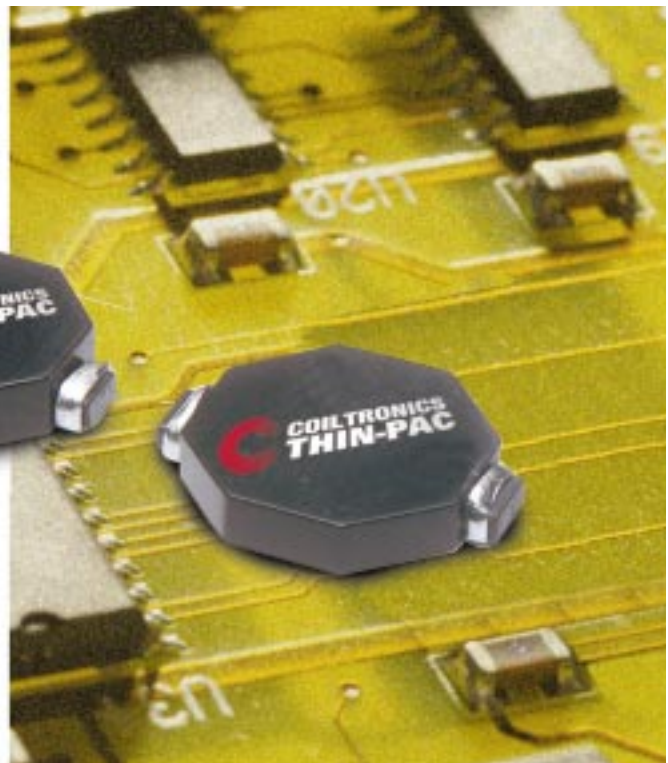
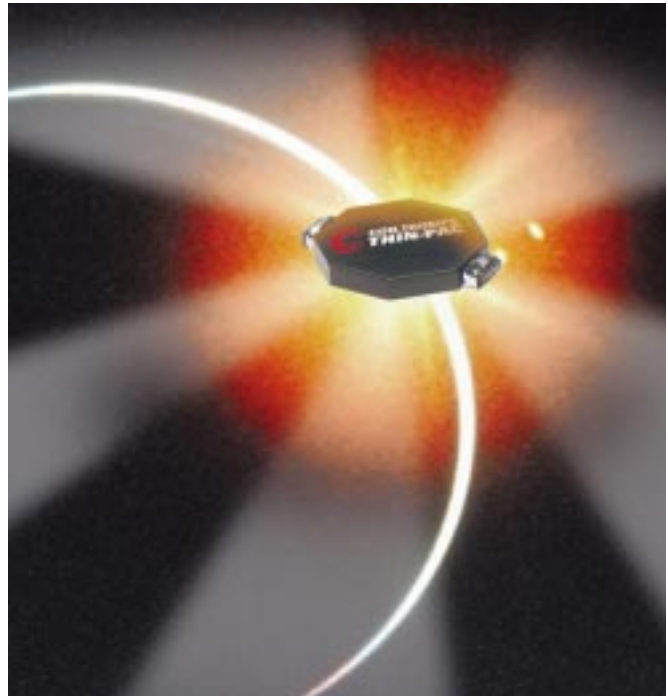

FEATURE - BENEFITS

- Ultrathin Product Profile - as Thin as 1.8 mm
- Highest Performance to Height Ratio of Any SMT Inductors
- Inductance Range from 0.47 to 47.0 μ H
- Current Range from 0.59 to 2.8 Amps
- Toroidal Cores provide Low EMI
- High Efficiency and High Q
- Supplied in Tape-and-Reel Packaging for Pick-and-Place Assembly
- Modified Standard Products Available

Coiltronics designs and manufactures standard and custom electromagnetic components. Contact the factory or your Coiltronics representative with your transformer and inductor requirements.

THIN-PAC 1 FAMILY TABLE

Part Number	Inductance μH (rated)	OCL ⁽¹⁾ μH +/-20%	I _{RMS} ⁽²⁾ Amperes	I _{SAT} ⁽³⁾ Amperes	DCR ⁽⁴⁾ Ohms max.
TP1-R47	0.47	0.544	1.7	3.0	0.1085
*TP1-1R0	1.0	1.17	1.5	2.6	0.1401
TP1-1R5	1.5	1.57	1.4	2.2	0.1560
*TP1-2R2	2.2	2.55	1.3	1.8	0.1876
TP1-3R3	3.3	3.73	1.2	1.5	0.2246
*TP1-4R7	4.7	5.10	1.1	1.3	0.2647
TP1-6R8	6.8	7.45	0.96	1.1	0.3240
*TP1-100	10.0	10.31	0.90	0.92	0.3739
*TP1-150	15.0	16.57	0.81	0.73	0.4612
*TP1-220	22.0	24.25	0.74	0.60	0.5483
*TP1-330	33.0	38.56	0.66	0.47	0.6847
*TP1-470	47.0	49.49	0.62	0.43	0.7699

Notes: (1) Open Circuit Inductance Test Parameters: 100 KHz, 0.250 Vrms, 0.0 Adc.
 (2) RMS current for an approximate ΔT of 40°C. at an ambient temperature of 85°C.
 (3) Peak current for approximately 30% rolloff.
 (4) Values @ 20°C.

***BOLD are available from stock**

Coiltronics Incorporated reserves the right to change component specifications without notice.

TP1-1R0

Typical Inductance & Energy vs Saturation Current

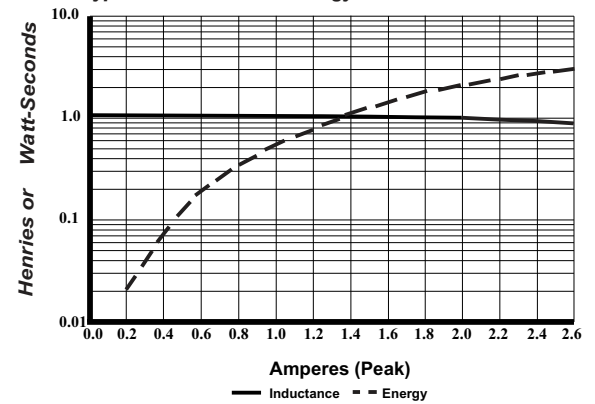

TP1-100

Typical Inductance & Energy vs Saturation Current

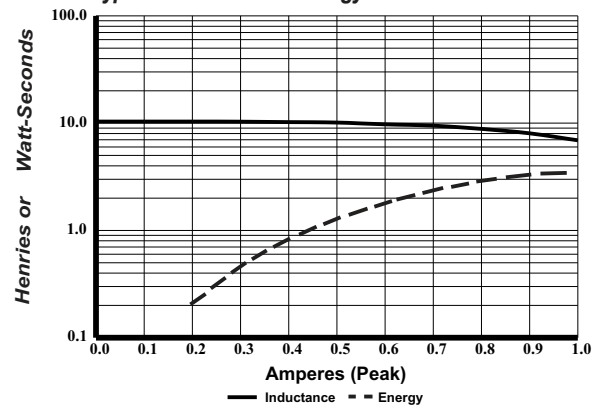

TP1-470

Typical Inductance & Energy vs Saturation Current

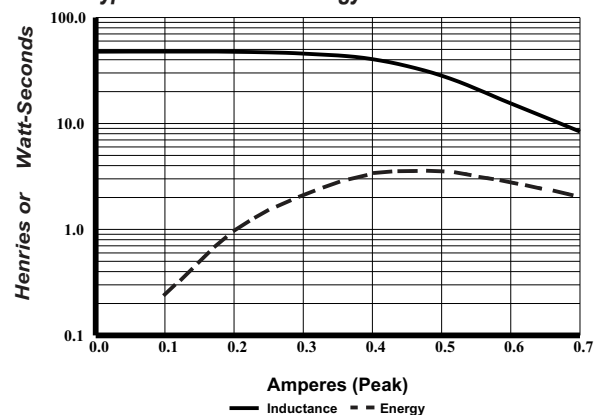

MECHANICAL DIAGRAM

TOP VIEW

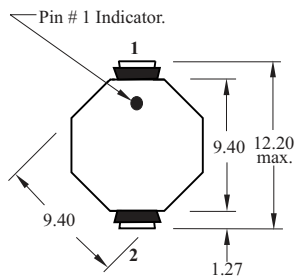

SIDE VIEW

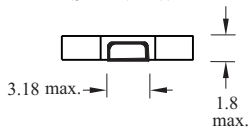

CONNECTION DIAGRAM

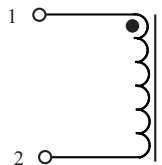

PACKAGING INFORMATION

Parts are packaged on 13" reels. 2250 parts per reel.

PCB PAD LAYOUT

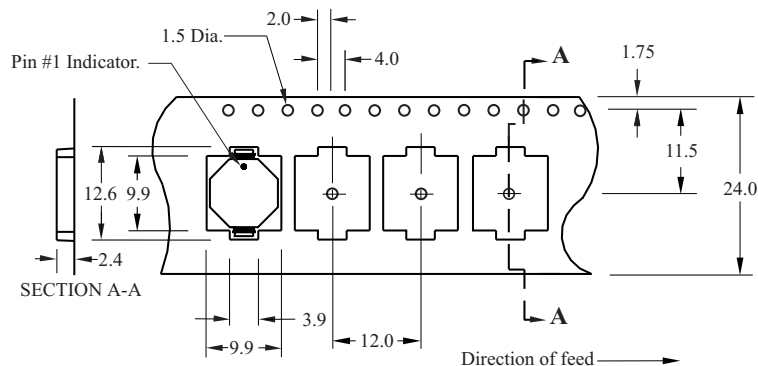
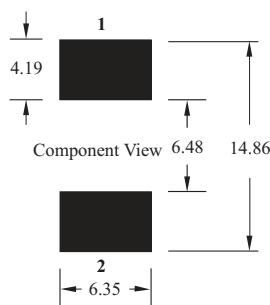

ACTUAL SIZE
THIN PAC 1

THIN-PAC 2 FAMILY TABLE

Part Number	Inductance μH (rated)	OCL ⁽¹⁾ μH +/-20%	I _{RMS} ⁽²⁾ Amperes	I _{SAT} ⁽³⁾ Amperes	DCR ⁽⁴⁾ Ohms max.
TP2-R47	0.47	0.399	2.2	3.2	0.0537
*TP2-1R0	1.0	1.00	1.8	2.1	0.0805
TP2-1R5	1.5	1.53	1.7	1.7	0.0910
*TP2-2R2	2.2	2.15	1.5	1.4	0.1110
TP2-3R3	3.3	3.45	1.4	1.1	0.1328
*TP2-4R7	4.7	4.56	1.3	0.97	0.1472
TP2-6R8	6.8	6.84	1.2	0.80	0.1797
*TP2-100	10.0	9.53	1.1	0.68	0.2151
*TP2-150	15.0	14.83	1.0	0.54	0.2512
*TP2-220	22.0	23.11	0.88	0.44	0.3269
*TP2-330	33.0	32.34	0.67	0.37	0.5677
*TP2-470	47.0	47.68	0.60	0.30	0.6962

Notes: (1) Open Circuit Inductance Test Parameters: 100 KHz, 0.250 Vrms, 0.0 Adc.
 (2) RMS current for an approximate ΔT of 40°C. at an ambient temperature of 85°C.
 (3) Peak current for approximately 30% rolloff.
 (4) Values @ 20°C.

***BOLD are available from stock**

Coiltronics Incorporated reserves the right to change component specifications without notice.

MECHANICAL DIAGRAM

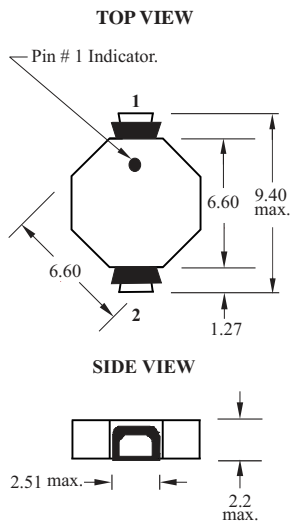

CONNECTION DIAGRAM

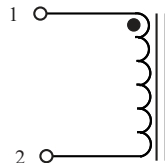

PCB PAD LAYOUT

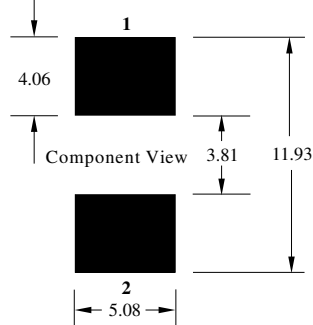

PACKAGING INFORMATION

Parts are packaged on 13" reels. 2000 parts per reel.

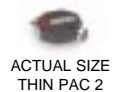
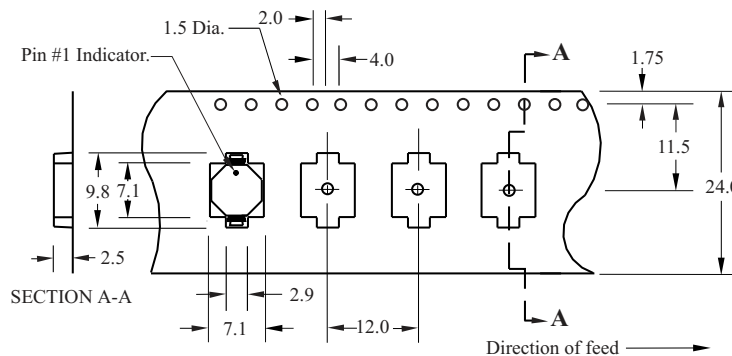

TP2-1R0

Typical Inductance & Energy vs Saturation Current

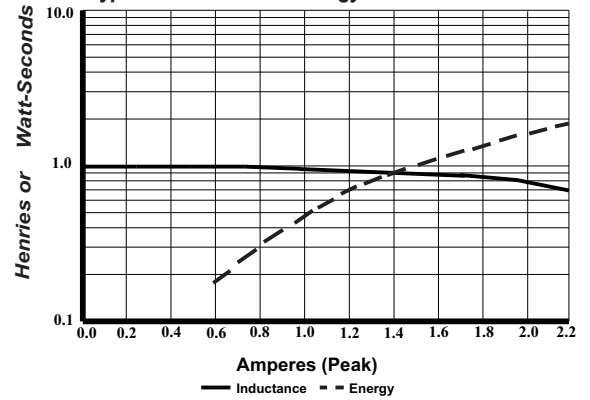

TP2-100

Typical Inductance & Energy vs Saturation Current

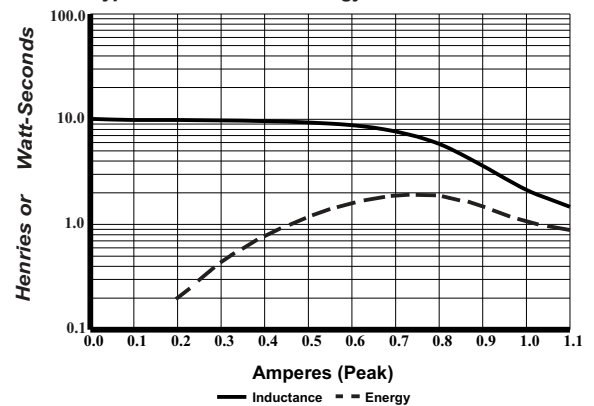

TP2-470

Typical Inductance & Energy vs Saturation Current

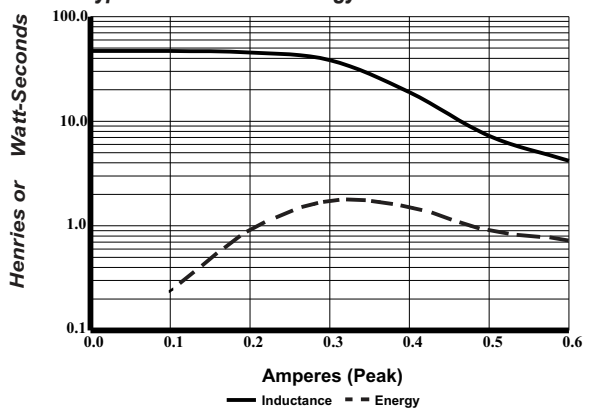

THIN-PAC 3 FAMILY TABLE

Part Number	Inductance μH (rated)	OCL ⁽¹⁾ μH +/-20%	I _{RMS} ⁽²⁾ Amperes	I _{SAT} ⁽³⁾ Amperes	DCR ⁽⁴⁾ Ohms max.
TP3-R47	0.47	0.417	2.6	4.2	0.0644
*TP3-1R0	1.0	1.15	2.1	3.4	0.0949
TP3-1R5	1.5	1.65	2.0	2.8	0.1064
*TP3-2R2	2.2	2.24	1.8	2.4	0.1241
TP3-3R3	3.3	3.68	1.7	1.9	0.1471
*TP3-4R7	4.7	5.45	1.5	1.6	0.1806
TP3-6R8	6.8	7.47	1.4	1.3	0.2051
*TP3-100	10.0	11.09	1.3	1.1	0.2550
*TP3-150	15.0	15.17	1.2	0.97	0.2966
*TP3-220	22.0	23.99	1.1	0.78	0.3700
*TP3-330	33.0	35.08	0.96	0.64	0.4433
*TP3-470	47.0	47.71	0.90	0.55	0.5122

Notes: (1) Open Circuit Inductance Test Parameters: 100 KHz, 0.250 Vrms, 0.0 Adc.
 (2) RMS current for an approximate ΔT of 40°C. at an ambient temperature of 85°C.
 (3) Peak current for approximately 30% rolloff.
 (4) Values @ 20°C.

***BOLD are available from stock**

Coiltronics Incorporated reserves the right to change component specifications without notice.

TP3-1R0
Typical Inductance & Energy vs Saturation Current

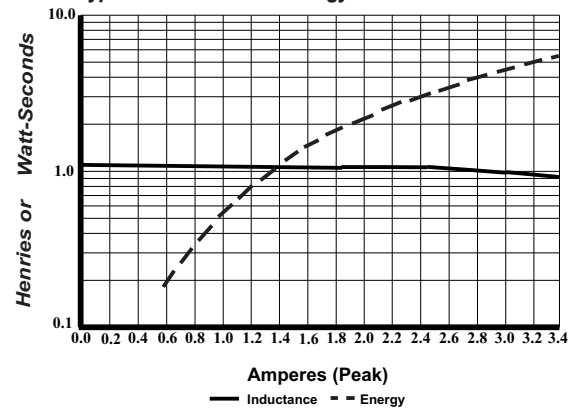

TP3-100
Typical Inductance & Energy vs Saturation Current

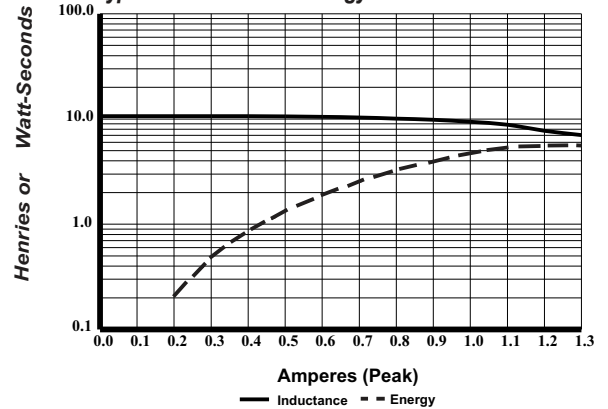

TP3-470
Typical Inductance & Energy vs Saturation Current

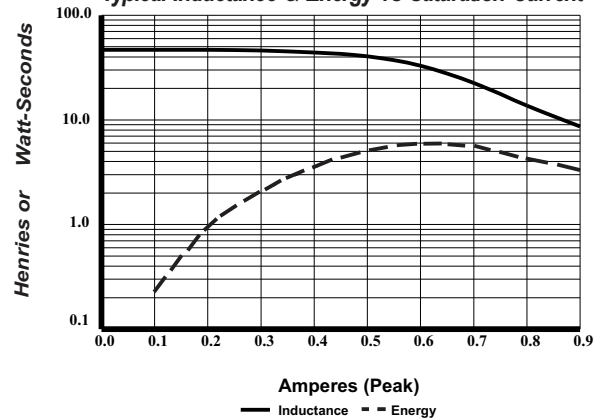

MECHANICAL DIAGRAM

TOP VIEW

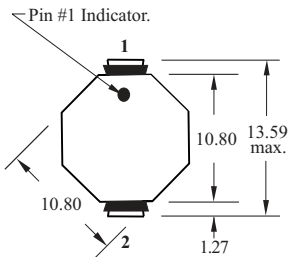

SIDE VIEW

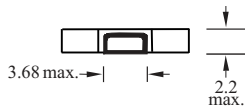

PCB PAD LAYOUT

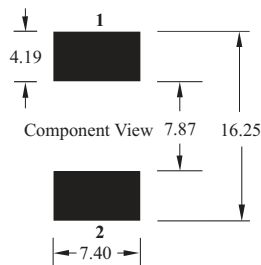

CONNECTION DIAGRAM

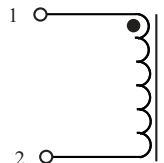

PACKAGING INFORMATION

Parts are packaged on 13" reels. 1500 parts per reel.

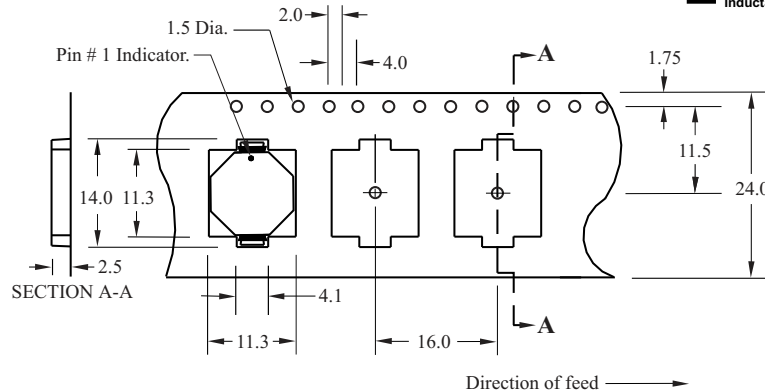

ACTUAL SIZE
THIN PAC 3

THIN-PAC 4 FAMILY TABLE

Part Number	Inductance μH (rated)	OCL ⁽¹⁾ μH +/-20%	I _{RMS} ⁽²⁾ Amperes	I _{SAT} ⁽³⁾ Amperes	DCR ⁽⁴⁾ Ohms max.
TP4-R47	0.47	0.507	2.8	6.3	0.0411
*TP4-1R0	1.0	1.09	2.4	4.4	0.0536
TP4-1R5	1.5	1.85	2.2	3.4	0.0641
*TP4-2R2	2.2	2.22	2.1	3.2	0.0715
TP4-3R3	3.3	3.21	2.0	2.7	0.0802
*TP4-4R7	4.7	5.05	1.8	2.2	0.1037
TP4-6R8	6.8	6.54	1.7	1.9	0.1168
*TP4-100	10.0	10.14	1.5	1.6	0.1458
*TP4-150	15.0	14.49	1.4	1.3	0.1727
*TP4-220	22.0	21.33	1.0	1.1	0.3068
*TP4-330	33.0	32.74	0.80	0.87	0.4922
*TP4-470	47.0	47.42	0.59	0.72	0.9080

Notes: (1) Open Circuit Inductance Test Parameters: 100 KHz, 0.250 Vrms, 0.0 Adc.
 (2) RMS current for an approximate ΔT of 40°C. at an ambient temperature of 85°C.
 (3) Peak current for approximately 30% rolloff.
 (4) Values @ 20°C.

***BOLD are available from stock**

Coiltronics Incorporated reserves the right to change component specifications without notice.

MECHANICAL DIAGRAM

TOP VIEW

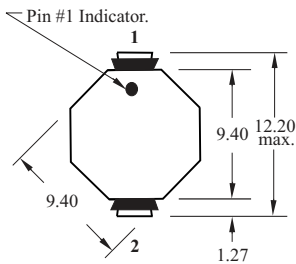

SIDE VIEW

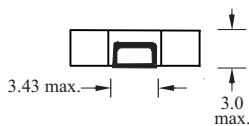

PCB PAD LAYOUT

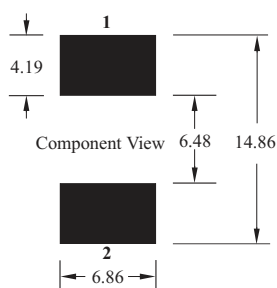

CONNECTION DIAGRAM

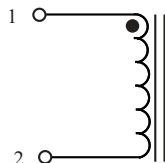

PACKAGING INFORMATION

Parts are packaged on 13" reels. 1500 parts per reel.

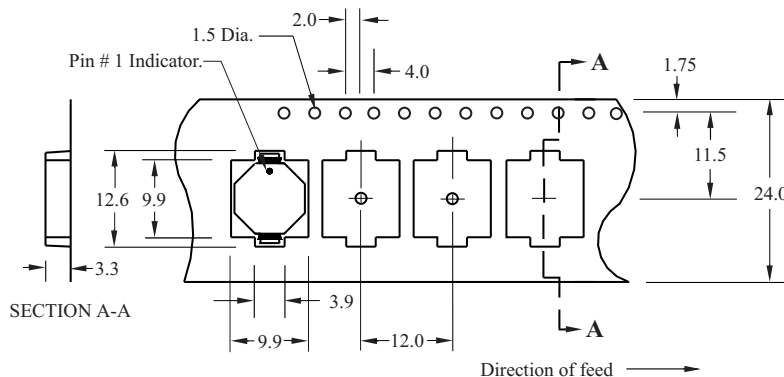

ACTUAL SIZE
THIN PAC 4

TP4-1R0

Typical Inductance & Energy vs Saturation Current

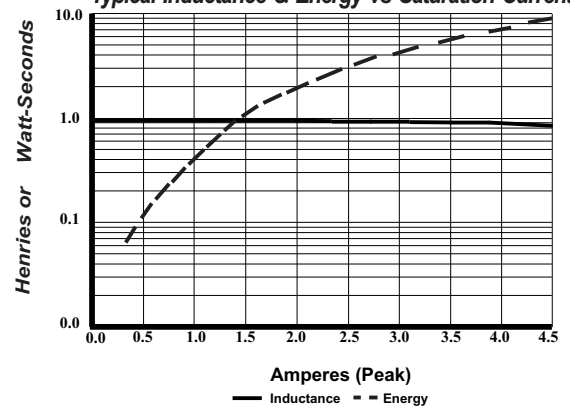

TP4-100

Typical Inductance & Energy vs Saturation Current

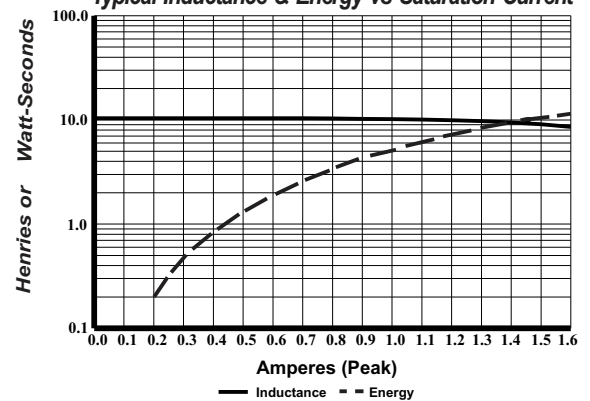

TP4-470

Typical Inductance & Energy vs Saturation Current

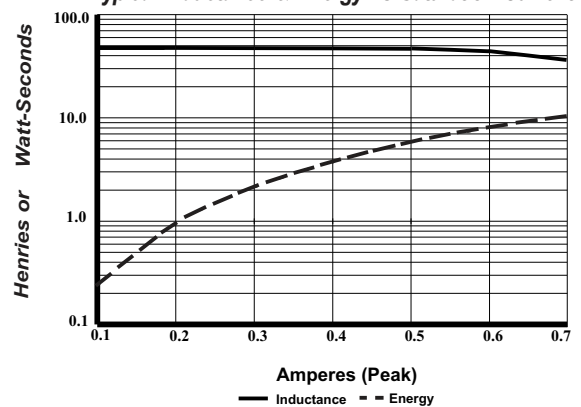

ENVIRONMENTAL SPECIFICATIONS

- Storage Temperature Range:
-40°C to +125°C.
- Operating Ambient Temperature Range:
-40°C to +85°C
Range is application specific
- Infrared Reflow Temperature:
+240°C for 30 seconds maximum
- Meets UL 94V-O Flammability Standard

DESIGN KITS AVAILABLE

To assist in prototyping, Coiltronics offers low-cost Design Kits for the THIN-PAC product family. Each Kit contains an assortment of inductance values complete with specifications. Coiltronics Design Kits can save hours (even days) of searching for parts and waiting on samples.

- Order Part Number TPK01-13692



Information furnished herein by Coiltronics Incorporated is believed to be accurate and reliable. However, Coiltronics Incorporated cannot assume responsibility for the use of any of our components, nor for any liabilities which may result from component use. Coiltronics Incorporated reserves the right to change component specifications without notice.

Life Support Policy: Coiltronics Incorporated does not authorize the use of any of its products for use in life support devices or systems without the express written approval of an officer of Coiltronics Incorporated. Life support systems are devices which support or sustain life, and whose failure to perform, when properly used in accordance with instructions for use provided in the labeling, can be reasonably expected to result in significant injury to the user.

©1997 Coiltronics Incorporated. All rights reserved.

