

**Unlocking
Tool**

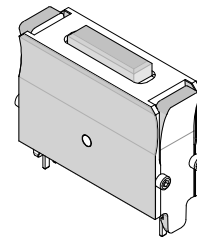

**Application Tooling
Specification Sheet**



Order No. 63824-3900

FEATURES

- This Tool is for locking and unlocking the TPA from a 70 Way CMX or Euro6 Connector.

SCOPE

Products: CMX Receptacle Connectors

Connector Series No.	Connector Order No.					
34853	34853-0111	34853-0112	34853-0113	34853-0114	34853-0115	34853-0116
	34853-0121	34853-0122	34853-0123	34853-0124	34853-0125	34853-0126

Unlocking and Opening the (TPA) Secondary Lock

For the CMX receptacle assembly, follow the steps below:

1. Insert the tool into the (2) side slots of the (TPA) secondary lock on each sides until it stops. See Figure 1. The (2) two catch pivots on the sides of the tool will engage the TPA.
2. Push on the tool until the TPA contacts with the inside edge of the tool and the locking latches click into place.
3. The tool is now secure on the in the TPA. See Figure 2.
4. Gently push the blade engagement slide "IN" until it is about even with the face of the tool.
5. Still holding the front of the tool, pull out until the TPA stops.
6. Remove the tool and check the position of the TPA.

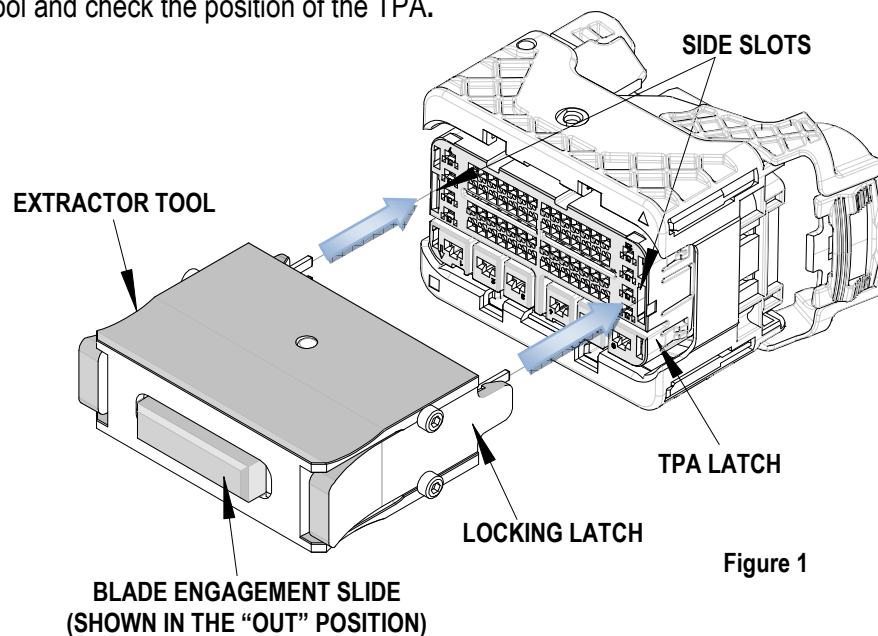

Figure 1

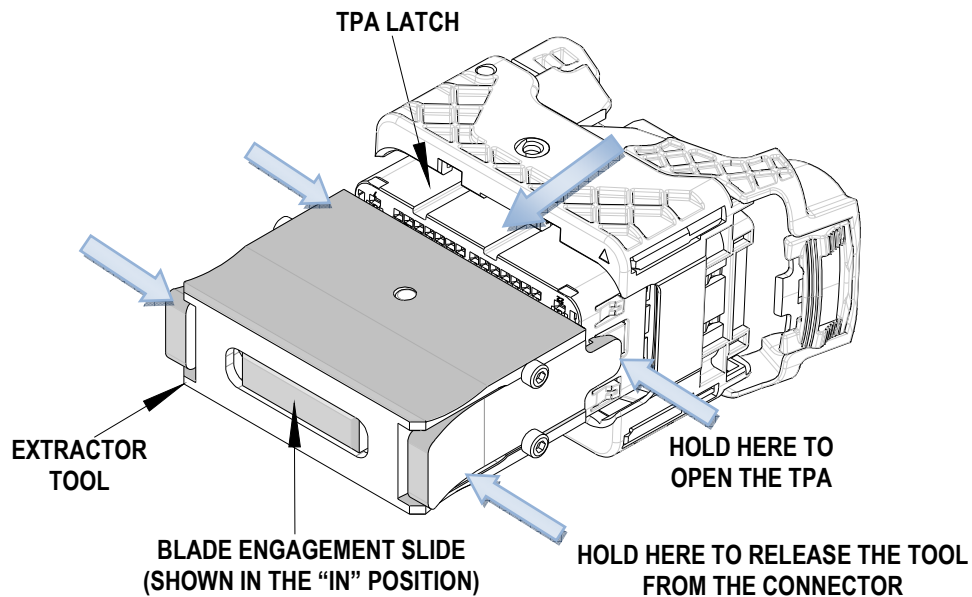

Figure 2

Closing the (TPA) secondary lock

On a CMX receptacle assembly, follow the steps below:

Secondary lock can be closed manually or during the final connector check.

This procedure is done after the insertion of all female terminals.

1. Insert the extractor tool into the (2) side slots of the (TPA) secondary lock on each sides.
2. Pull out with the tool. See Figure 2.
3. Remove the tool and check for placement.

Note:

One of the functions of the secondary lock (TPA) is to detect if any of the terminals are not fully seated in the cavities. If the secondary lock does not close, reopen the TPA.

Push on the terminals one at a time to make sure they are locked in place.

Close the secondary lock see step 2 and 3.

Check visually the locking latches are in the correct position.

Visit our Web site at <http://www.molex.com>