

REVISIONS

P	LTR	DESCRIPTION	DATE	DWN	APVD
C4		NOTES CORRECTED AND PART STATUS UPDATED	06APR2018	RK	PS
C5		3-1546105-4 PART OBSOLETE	27AUG2020	DV	PS

NOTES:

- MATERIALS AND FINISH
HOUSING: PA 6-6, UL 94-V0, COLOR: GREEN.
CLAMP: BRASS, NICKEL PLATED.
CONTACT SPRING: PHOSPHOR BRONZE, FINISH: SEE TABLE.
CLAMPING SCREW: M3, BRASS, NICKEL PLATED.
- MECHANICAL
WIRE STRIPPING LENGTH : 6.0-7.5 mm
RECOMMENDED TIGHTENING TORQUE FOR SCREW : 0.5 Nm.
- ELECTRICAL
WIRE RANGE : 12-30 AWG
MAX. VOLTAGE : 300 V
MAX CURRENT : 15 A
CONTACT RESISTANCE : <15 m Ohm
INSULATION RESISTANCE : >1000 M Ohm (500V DC)
- INK MARKING: WHITE COLOR.

5 TOLERANCE NOT CUMULATIVE.

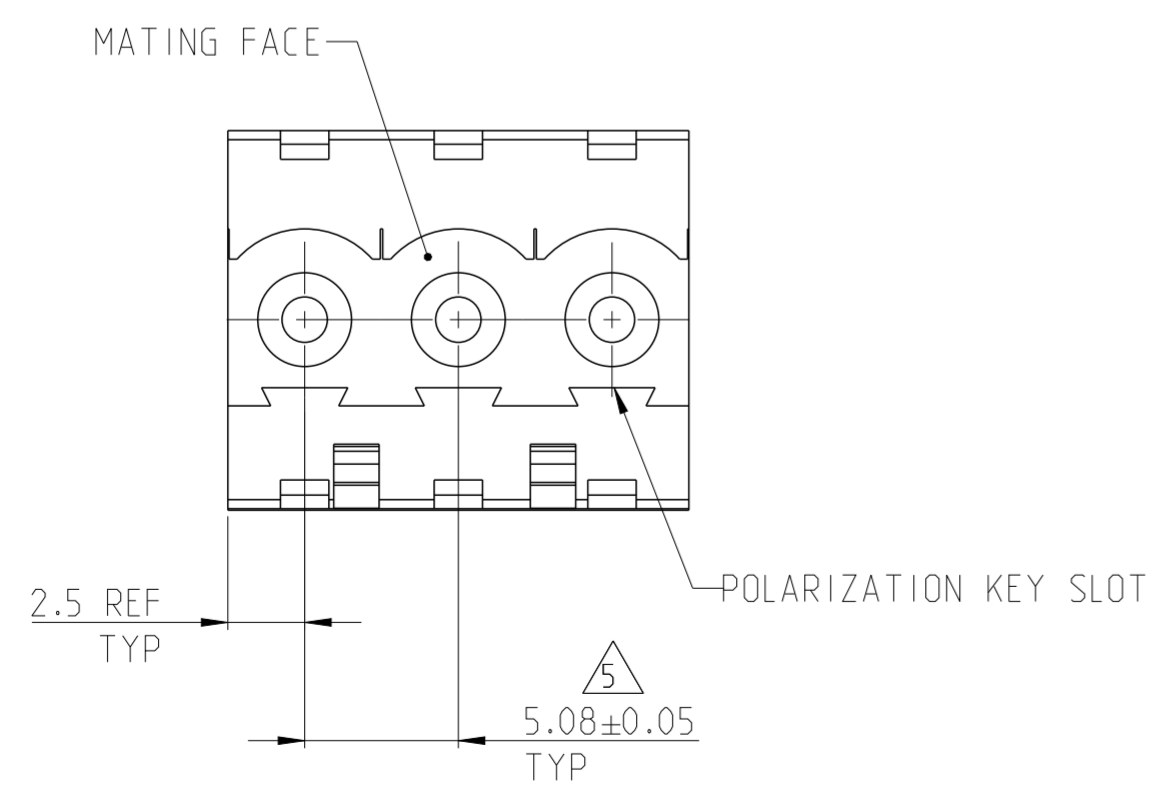
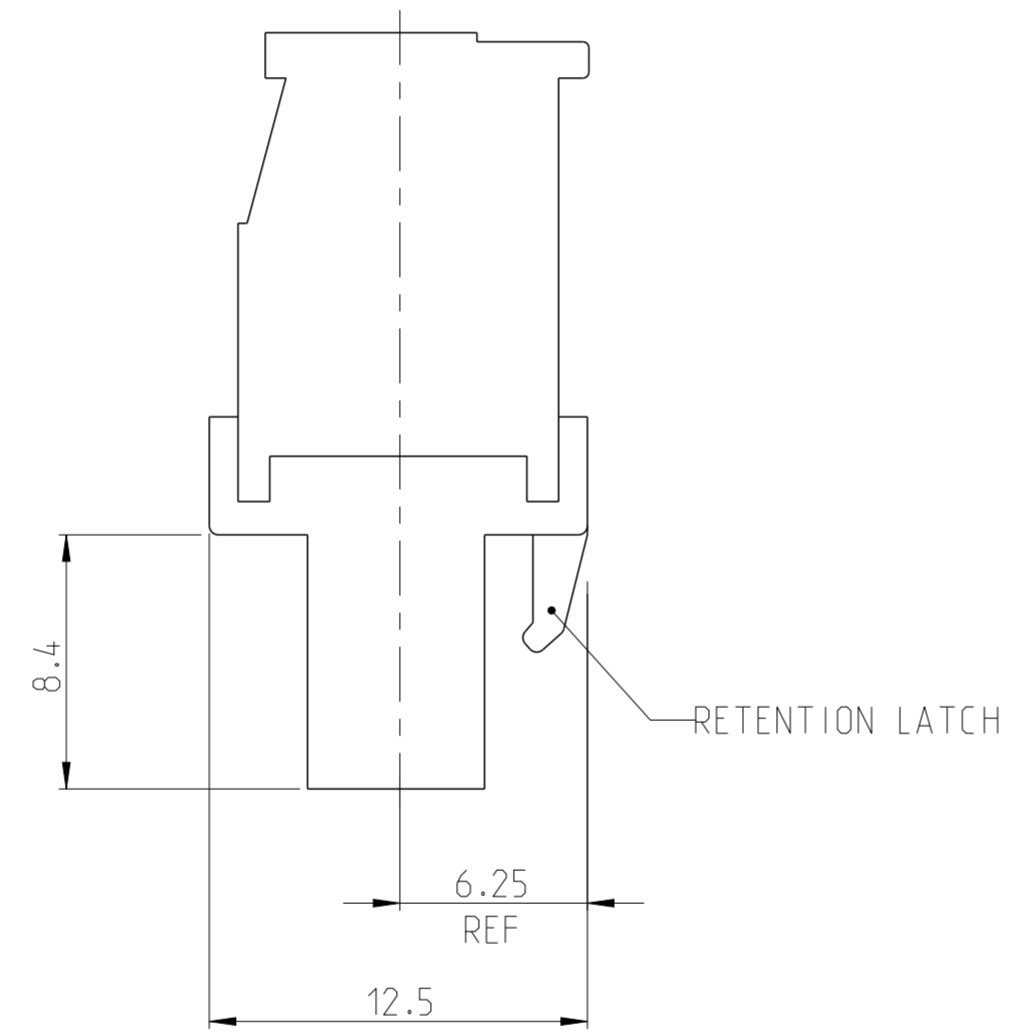
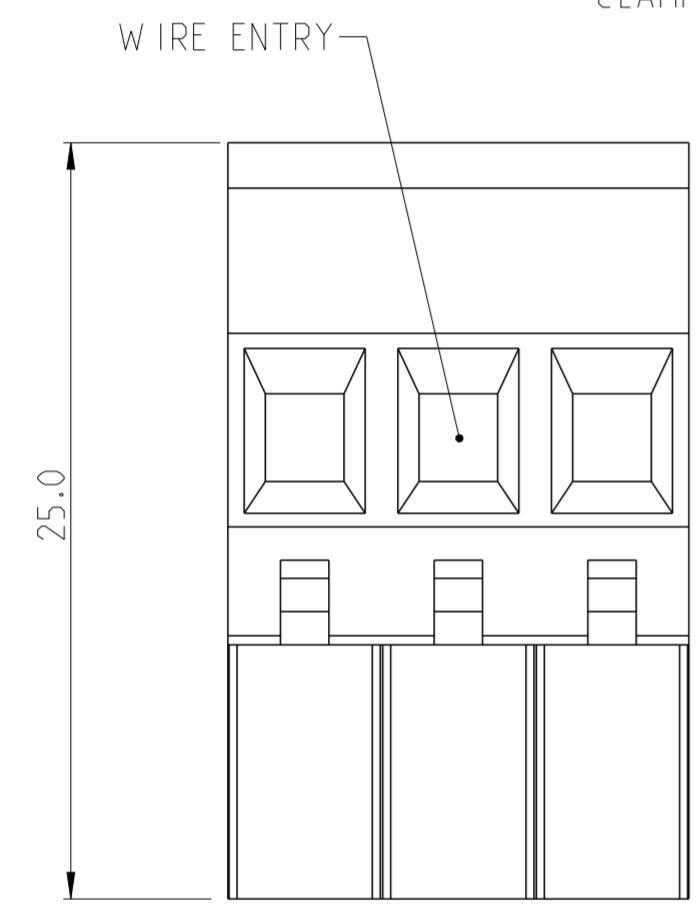
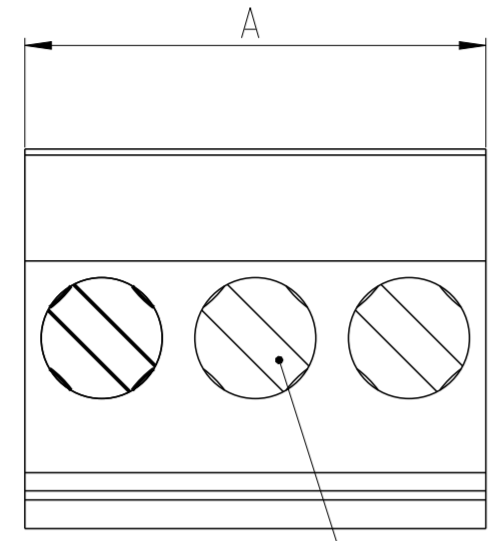

OBSOLETE	SEE DETAIL Z	TIN	20.32	4	5-1546105-4
OBSOLETE	SEE DETAIL X	TIN	60.96	12	6-1546105-0
OBSOLETE	-	.762 μm GOLD	50.80	10	5-1546105-9
OBSOLETE	-	.762 μm GOLD	40.64	8	5-1546105-8
OBSOLETE	-	.762 μm GOLD	35.56	7	5-1546105-7
OBSOLETE	SEE DETAIL W	TIN	60.96	12	5-1546105-6
OBSOLETE	SEE DETAIL V	TIN	76.20	15	5-1546105-5
OBSOLETE	SEE DETAIL U	TIN	45.72	9	4-1546105-9
OBSOLETE	SEE DETAIL T	TIN	40.64	8	4-1546105-8
OBSOLETE	SEE DETAIL S	TIN	30.48	6	4-1546105-6
OBSOLETE	SEE DETAIL R	TIN	20.32	4	4-1546105-4
OBSOLETE	SEE DETAIL P	TIN	50.80	10	4-1546105-0
OBSOLETE	SEE DETAIL N	TIN	30.48	6	3-1546105-6
OBSOLETE	SEE DETAIL M	TIN	25.40	5	3-1546105-5
OBSOLETE	SEE DETAIL L	TIN	20.32	4	3-1546105-4
OBSOLETE	SEE DETAIL K	TIN	66.04	13	3-1546105-3
OBSOLETE	SEE DETAIL J	TIN	50.80	10	3-1546105-0
-	-	TIN	127.00	25	2-1546105-5
-	-	TIN	121.92	24	2-1546105-4
-	-	TIN	116.84	23	2-1546105-3
-	-	TIN	111.76	22	2-1546105-2
-	-	TIN	106.68	21	2-1546105-1
-	-	TIN	101.60	20	2-1546105-0
-	-	TIN	96.52	19	1-1546105-9
-	-	TIN	91.44	18	1-1546105-8
-	-	TIN	86.36	17	1-1546105-7
-	-	TIN	81.28	16	1-1546105-6
-	-	TIN	76.20	15	1-1546105-5
-	-	TIN	71.12	14	1-1546105-4
-	-	TIN	66.04	13	1-1546105-3
-	-	TIN	60.96	12	1-1546105-2
-	-	TIN	55.88	11	1-1546105-1
-	-	TIN	50.80	10	1-1546105-0
-	-	TIN	45.72	9	1546105-9
-	-	TIN	40.64	8	1546105-8
-	-	TIN	35.56	7	1546105-7
-	-	TIN	30.48	6	1546105-6
-	-	TIN	25.40	5	1546105-5
-	-	TIN	20.32	4	1546105-4
-	-	TIN	15.24	3	1546105-3
-	-	TIN	10.16	2	1546105-2
MARKING	CONTACT FINISH	A	NO OF POSN	PART NUMBER	

THIS DRAWING IS A CONTROLLED DOCUMENT.

DWN S.WELDON 03SEP2002
CHK C.RICHARD 03SEP2002
APVD C.RICHARD 03SEP2002

TE Connectivity

NAME: TERMINAL BLOCK VERTICAL PLUG STACKING LEFT HAND 5.08mm PITCH

SIZE: A2 CAGE CODE: 00779 DRAWING NO: C-1546105

SCALE: 4:1 SHEET: 1 OF 2 REV: C5

RESTRICTED TO

REVISIONS

P	LTR	DESCRIPTION	DATE	DWN	APVD
-		SEE SHEET 1	-	-	-

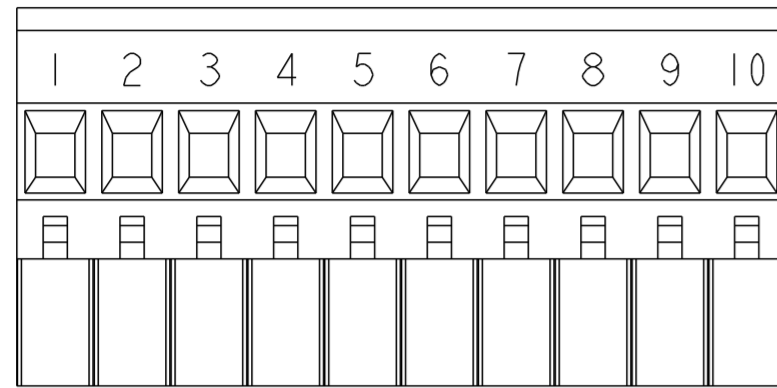

DETAIL J
SCALE 2:1

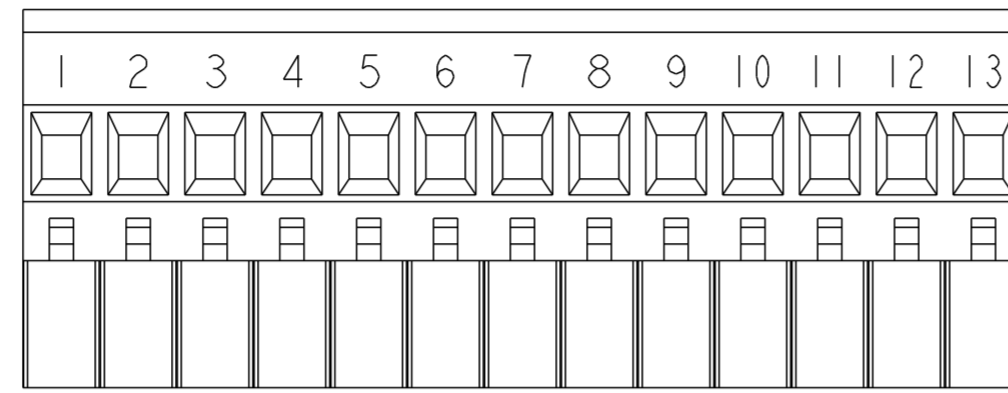

DETAIL K
SCALE 2:1

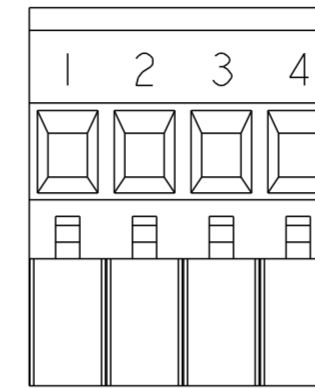

DETAIL L
SCALE 2:1

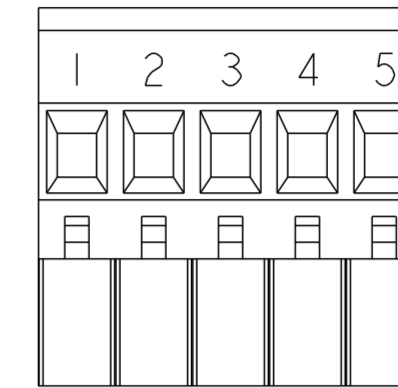

DETAIL M
SCALE 2:1

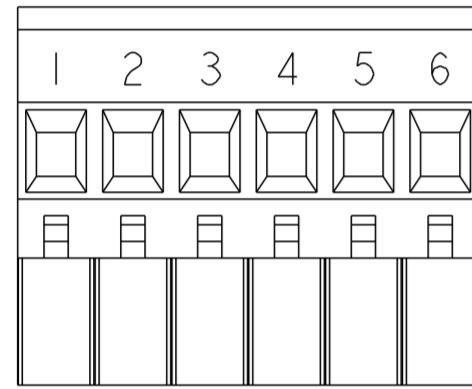

DETAIL N
SCALE 2:1

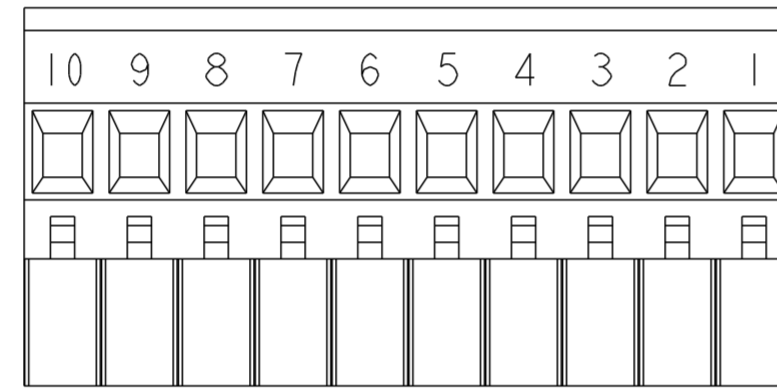

DETAIL P
SCALE 2:1

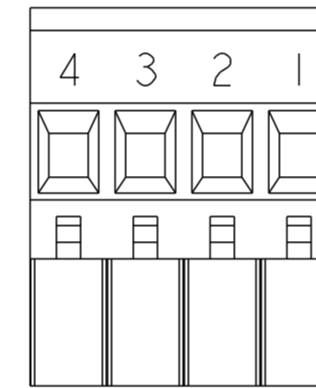

DETAIL R
SCALE 2:1

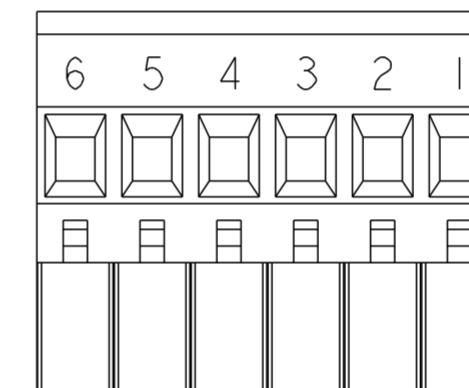

DETAIL S
SCALE 2:1

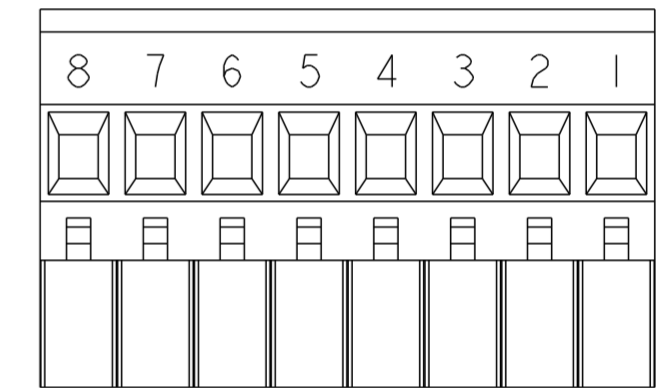

DETAIL T
SCALE 2:1

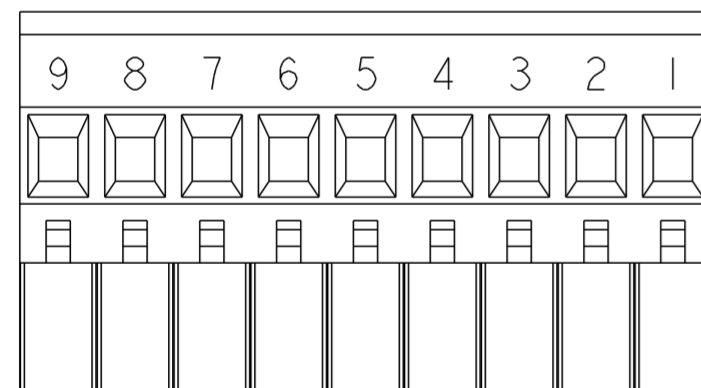

DETAIL U
SCALE 2:1

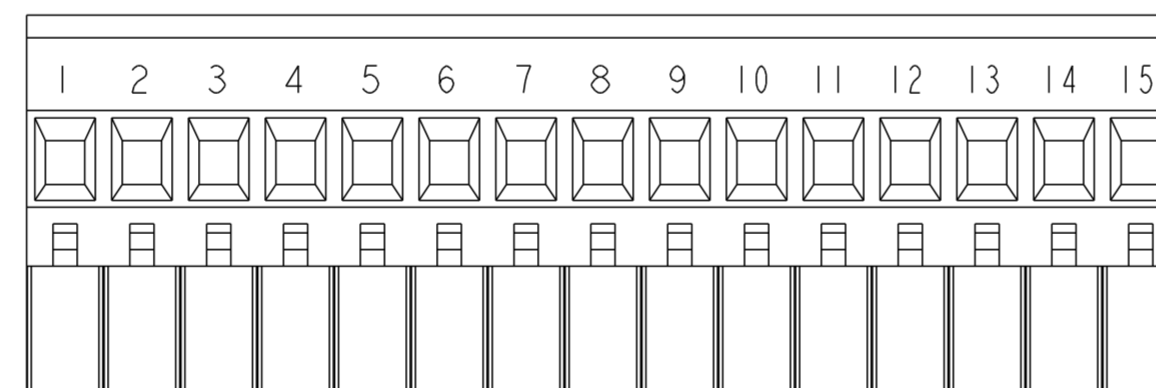

DETAIL V
SCALE 2:1

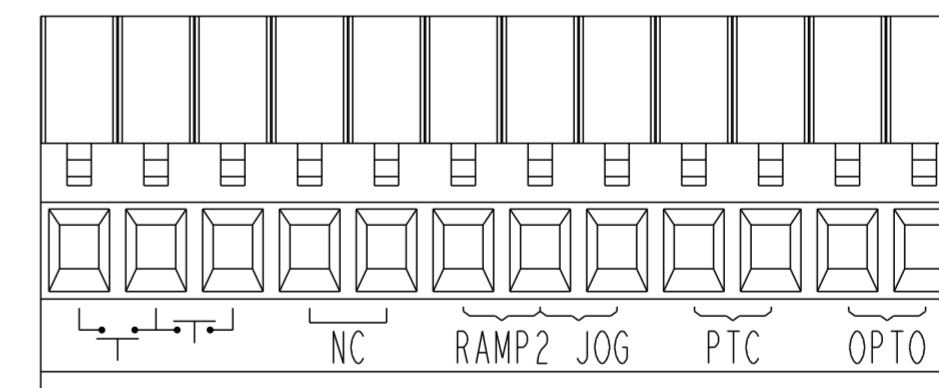

DETAIL W
SCALE 2:1

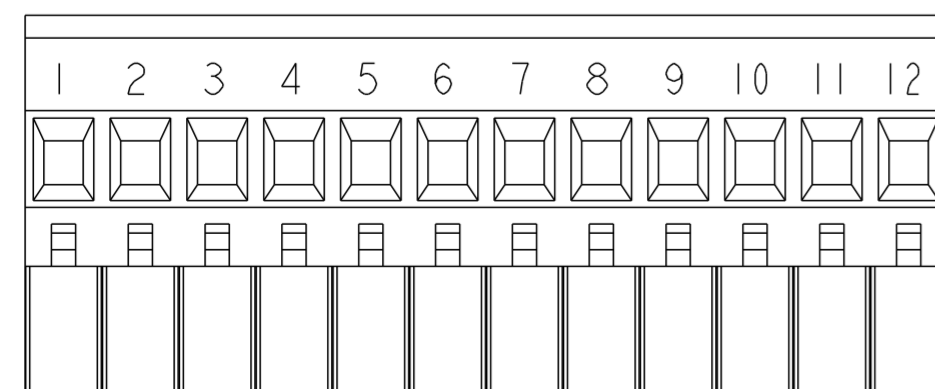

DETAIL X
SCALE 2:1

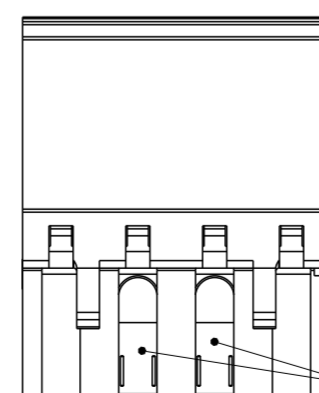

DETAIL Z
SCALE 2:1

CODING KEYS

THIS DRAWING IS A CONTROLLED DOCUMENT.		DWN S. WELDON 03SEP2002	
DIMENSIONS: mm		CHK C. RICHARD 03SEP2002	
TOLERANCES UNLESS OTHERWISE SPECIFIED: 0 PLC ± 1 PLC ±0.3 2 PLC ±0.25 3 PLC ± 4 PLC ± ANGLES ±2° FINISH		APVD C. RICHARD 03SEP2002	NAME TERMINAL BLOCK VERTICAL PLUG STACKING LEFT HAND 5.08mm PITCH
MATERIAL SEE NOTES		PRODUCT SPEC -	SIZE A2
		APPLICATION SPEC -	CAGE CODE 00779
		WEIGHT -	DRAWING NO 1546105
		CUSTOMER DRAWING	RESTRICTED TO
		SCALE 3:1	SHEET 2 OF 2
			REV C5