

TERMSERIES TRP 5VDC 2CO EMPTY

Weidmüller Interface GmbH & Co. KG
 Klingenbergstraße 26
 D-32758 Detmold
 Germany
 Fon: +49 5231 14-0
 Fax: +49 5231 14-292083
 www.weidmueller.com

Product image



Similar to illustration

TERMSERIES accessories include:

- Spare relay
- Base
- Partition plates
- Cross-connections
- Power-feed modules

General ordering data

Type	TRP 5VDC 2CO EMPTY
Order No.	2680850000
Version	TERMSERIES, Relay bases, Number of contacts: 2 CO contact, Rated control voltage: 5 V DC \pm 20 %, Continuous current: 10 A, PUSH IN
GTIN (EAN)	4050118695151
Qty.	10 pc(s).

Creation date May 5, 2020 10:21:15 PM CEST

Catalogue status 01.05.2020 / We reserve the right to make technical changes.

TERMSERIES
TRP 5VDC 2CO EMPTY

Weidmüller Interface GmbH & Co. KG
 Klingenbergstraße 26
 D-32758 Detmold
 Germany
 Fon: +49 5231 14-0
 Fax: +49 5231 14-292083
 www.weidmueller.com

Technical data**Dimensions and weights**

Width	12.8 mm	Width (inches)	0.504 inch
Height	89.4 mm	Height (inches)	3.52 inch
Depth	87.8 mm	Depth (inches)	3.457 inch
Net weight	44.5 g		

Temperatures

Operating temperature, max.	60 °C	Operating temperature, min.	-40 °C
Storage temperature, max.	85 °C	Storage temperature, min.	-40 °C
Operating temperature	-40 °C...60 °C	Storage temperature	-40 °C...85 °C

Rated data UL

Certificate No. (cURus)	E223759	Ambient temperature (operational), max.	60 °C
Output current derating (ohmic)	6 A @ 60 °C, 8 A @ 50 °C	Connection cross-section AWG, min.	AWG 26
Connection cross-section AWG, max.	AWG 14	Type of conductor	rigid copper conductor, flexible copper conductor
Tightening torque, max.	0.4 Nm	Pollution severity level	2
Altitude	≤ 2000 m, above sea level		

Input

Rated control voltage	5 V DC ± 20 %	Status indicator	Green LED
Protective circuit	Free-wheeling diode, Reverse polarity protection	Coil voltage of the replacement relay deviating from the rated control voltage	No
Coil voltage of the replacement relay	5 V DC		

Output

Rated switching voltage	250 V AC	Continuous current	10 A
-------------------------	----------	--------------------	------

Contact data

Contact type	2 CO contact
--------------	--------------

General data

Rail	TS 35	Colour	black
UL 94 flammability rating	V-0		

Insulation coordination

Rated voltage	300 V	Surge voltage category	III
Pollution severity	2	Protection degree	IP20
Dielectric strength, Input/Output	1.2 kV _{eff} / 5 s	Creepage and clearance distance input – output	≥ 5.5 mm
Dielectric strength of neighbouring contacts	2.5 kV _{eff}	Dielectric strength to mounting rail	4 kV _{eff} / 1 Min.
Impulse withstand voltage	6 kV (1.2/50 μs)		

Further details of approvals / standards

Certificate No. (cURus)	E223759
-------------------------	---------

TERMSERIES
TRP 5VDC 2CO EMPTY

Weidmüller Interface GmbH & Co. KG
 Klingenbergstraße 26
 D-32758 Detmold
 Germany
 Fon: +49 5231 14-0
 Fax: +49 5231 14-292083
 www.weidmueller.com

Technical data**Connection data**

Wire connection method	PUSH IN	Stripping length, rated connection	8 mm
Clamping range, rated connection	1.5 mm ²	Clamping range, min.	0.14 mm ²
Clamping range, max.	2.5 mm ²	Wire connection cross section AWG, min.	AWG 26
Wire connection cross section AWG, max.	AWG 14	Wire cross-section, solid, min.	0.14 mm ²
Wire cross-section, solid, max.	2.5 mm ²	Wire connection cross-section, finely stranded, min.	0.14 mm ²
Wire connection cross section, finely stranded, max.	2.5 mm ²	Wire cross-section, finely stranded, min. (AWG)	AWG 26
Wire cross-section, finely stranded, max. (AWG)	AWG 14	Wire connection cross-section, finely stranded with wire-end ferrules DIN 46228/4, min.	0.25 mm ²
Wire connection cross-section, finely stranded with wire-end ferrules DIN 46228/4, max.	2.5 mm ²	Conductor cross-section, flexible, AEH (DIN 46228-1), min.	0.25 mm ²
Conductor cross-section, flexible, AEH (DIN 46228-1), max.	2.5 mm ²	Wire connection cross section, finely stranded, two clampable wires, min.	0.5 mm ²
Wire cross-section, finely stranded, two clampable wires, max.	1 mm ²	Twin wire-end ferrules, min.	0.5 mm ²
Twin wire-end ferrules, max.	1 mm ²	Blade size	0.4 x 2.0 mm

Classifications

ETIM 6.0	EC001456	ETIM 7.0	EC001456
eClass 9.0	27-37-16-03	eClass 9.1	27-37-16-03
eClass 10.0	27-37-16-03		

Approvals

Approvals

**Downloads**

Approval/Certificate/Document of Conformity	EU Konformitätserklärung / EU Declaration of Conformity
Engineering Data	STEP
User Documentation	Beipackzettel / Package Insert – multilingual

**TERMSERIES
TRP 5VDC 2CO EMPTY**

Weidmüller Interface GmbH & Co. KG
Klingenbergstraße 26
D-32758 Detmold
Germany
Fon: +49 5231 14-0
Fax: +49 5231 14-292083
www.weidmueller.com

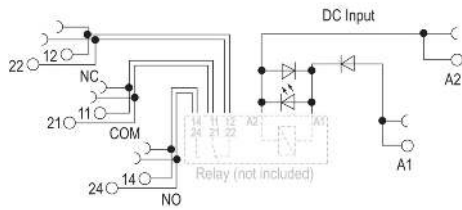
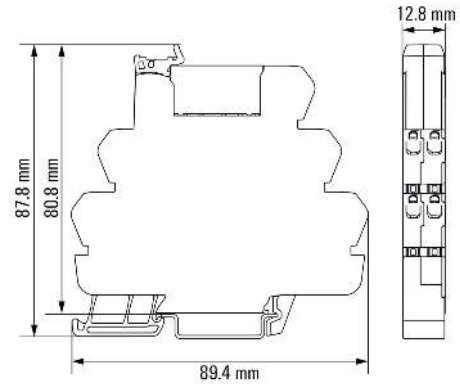
Drawings**Wiring diagram****Dimensional drawing**

**TERMSERIES
TRP 5VDC 2CO EMPTY**

Weidmüller Interface GmbH & Co. KG
 Klingenbergstraße 26
 D-32758 Detmold
 Germany
 Fon: +49 5231 14-0
 Fax: +49 5231 14-292083
 www.weidmueller.com

Drawings

Miscellaneous

Type code TERMSERIES electromechanical relay versions

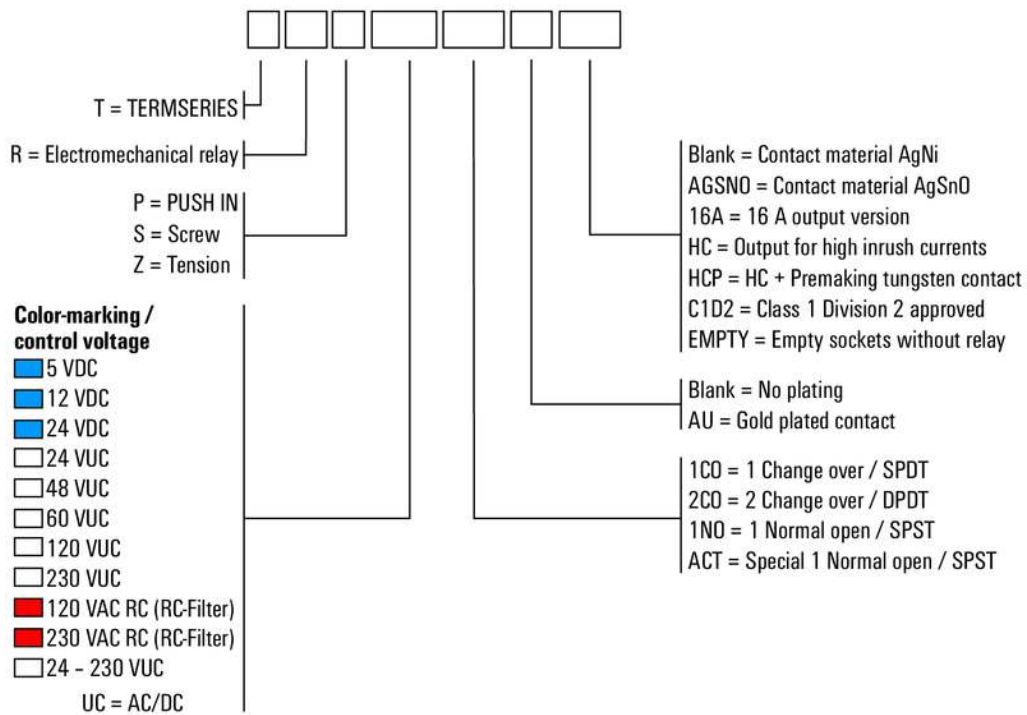

Type codes