



**MTA 156**

TE Internal #: 1-644752-2

Rectangular Power Connectors, Header, Plug, Wire-to-Board, 12 Position, 3.96 mm [.156 in] Centerline, Printed Circuit Board, UL 94V-0, MTA 156

[View on TE.com >](#)

Connectors > Power Connectors > Rectangular Power > Rectangular Power Connectors

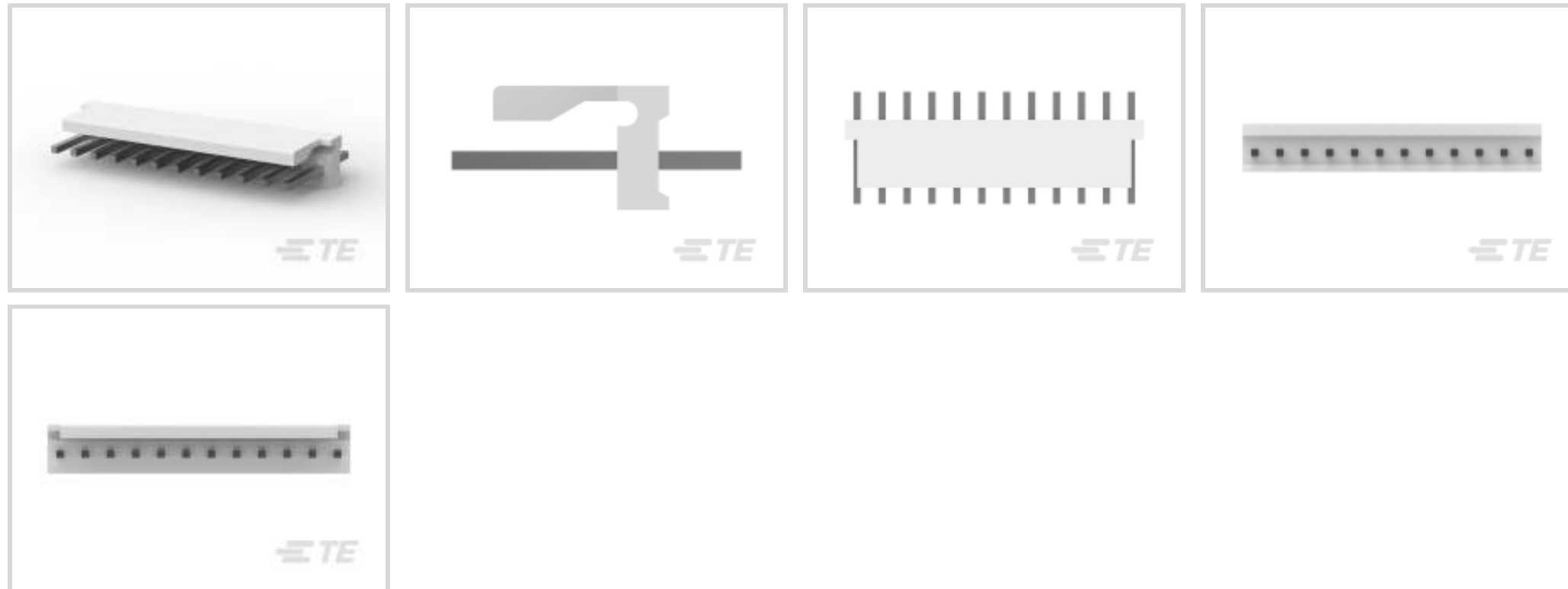

Rectangular Power Connector Type: **Header**

Connector & Housing Type: **Plug**

Connector System: **Wire-to-Board**

Number of Positions: **12**

Centerline (Pitch): **3.96 mm [.156 in]**

**Features**

**Product Type Features**

Header Type	Partially Shrouded
Rectangular Power Connector Type	Header
Connector & Housing Type	Plug
Connector System	Wire-to-Board
Sealable	No
Connector & Contact Terminates To	Printed Circuit Board

**Configuration Features**

Number of Positions	12
PCB Mount Orientation	Vertical
Number of Power Positions	12
Number of Rows	1

**Electrical Characteristics**

Operating Voltage	600 VAC
-------------------	---------

**Contact Features**



Mating Post Length	10.16 mm[.4 in]
PCB Contact Termination Area Plating Material Thickness	2.54 $\mu$ m[100 $\mu$ in]
Contact Layout	Inline
Contact Underplating Material Thickness	50 $\mu$ m[1.27 $\mu$ in]
Contact Mating Area Plating Material	Tin
Contact Underplating Material	Nickel
Contact Base Material	Copper Alloy
Contact Current Rating (Max)	7 A
Contact Retention Within Housing	Without
Contact Type	Pin
PCB Contact Termination Area Plating Material	Tin
Contact Mating Area Plating Material Thickness	2.54 $\mu$ m[100 $\mu$ in]

#### Termination Features

Termination Post & Tail Length	4.45 mm[.175 in]
Termination Method to Printed Circuit Board	Through Hole - Solder

#### Mechanical Attachment

Strain Relief	Without
Mating Retention	With
Mating Alignment	Without
PCB Mount Alignment	Without
Panel Mount Feature	Without
PCB Mount Retention	Without
Mating Retention Type	Friction Lock
Connector Mounting Type	Board Mount

#### Housing Features

Centerline (Pitch)	3.96 mm[.156 in]
Housing Color	Natural
Housing Material	Polyester - GF

#### Dimensions

Connector Height	13.34 mm[.525 in]
PCB Thickness (Recommended)	.06 mm[1.6 in]
Product Length	47.55 mm[1.872 in]



**Usage Conditions**

Operating Temperature Range	-55 – 105 °C[-67 – 221 °F]
-----------------------------	----------------------------

**Operation/Application**

Circuit Application	Power
---------------------	-------

**Industry Standards**

CSA Rating	Certified, LR 7189
UL Rating	Recognized
Agency/Standard	CSA, UL, VDE
Approved Standards	UL E28476
UL Flammability Rating	UL 94V-0
Glow Wire Rating	Standard Part - Not Glow Wire

**Packaging Features**

Packaging Quantity	500
Packaging Method	Package

**Product Compliance**

[For compliance documentation, visit the product page on TE.com>](#)

EU RoHS Directive 2011/65/EU	Compliant
EU ELV Directive 2000/53/EC	Compliant
China RoHS 2 Directive MIIT Order No 32, 2016	No Restricted Materials Above Threshold
EU REACH Regulation (EC) No. 1907/2006	Current ECHA Candidate List: JUNE 2023 (235) Candidate List Declared Against: JUNE 2023 (235) Does not contain REACH SVHC
Halogen Content	Not Low Halogen - contains Br or Cl > 900 ppm.
Solder Process Capability	Wave solder capable to 265°C

Product Compliance Disclaimer

This information is provided based on reasonable inquiry of our suppliers and represents our current actual knowledge based on the information they provided. This information is subject to change. The part numbers that TE has identified as EU RoHS compliant have a maximum concentration of 0.1% by weight in homogenous materials for lead, hexavalent chromium, mercury, PBB, PBDE, DBP, BBP, DEHP, DIBP, and 0.01% for cadmium, or qualify for an exemption to these limits as defined in the Annexes of Directive 2011/65/EU (RoHS2). Finished electrical and electronic equipment products will be CE marked as required by Directive 2011/65/EU. Components may not be CE marked. Additionally, the part numbers that TE has identified as EU ELV compliant have a maximum concentration of 0.1% by weight in homogenous materials for lead, hexavalent chromium, and mercury, and 0.01% for cadmium, or qualify for an exemption to these limits as defined in the Annexes of Directive 2000/53/EC (ELV). Regarding the REACH Regulation, the information TE provides

on SVHC in articles for this part number is based on the latest European Chemicals Agency (ECHA) 'Guidance on requirements for substances in articles' posted at this URL: <https://echa.europa.eu/guidance-documents/guidance-on-reach>

## Compatible Parts



TE Part # CAT-103156-WBHSM  
Receptacle Housing: Wire-to-Board, with Mating Alignment, SL156



TE Part # 1-640251-2  
12P SL156 HSG W/O LCK RAMP



TE Part # 4-640427-2  
12P MTA156 CONN ASSY 20AWG YEL



TE Part # 4-643818-2  
12P MTA156 CONN ASSY 20AWG YEL



TE Part # 4-640431-2  
12P MTA156 CONN ASSY 18AWG ORA



TE Part # 4-640426-2  
12P MTA156 CONN ASSY 18AWG ORA



TE Part # 1-640551-2  
12P MTA156 COVER



TE Part # 4-643819-2  
12P MTA156 CONN ASSY 22AWG LF



TE Part # 4-640599-2  
12P MTA156 CONN ASSY 18AWG ORA



TE Part # 1-643067-2  
12P MTA156 MOLDED COVER



TE Part # 1-643071-2  
12P MTA156 FD-THRU COVER



TE Part # 4-640429-2  
12P MTA156 CONN ASSY 24AWG WHT



TE Part # 4-640601-2  
12P MTA156 CONN ASSY 22AWG LF



TE Part # 4-640600-2  
12P MTA156 CONN ASSY 20AWG LF



TE Part # 4-644465-2  
12P MTA156 CONN ASSY 18AWG ORA



TE Part # 4-640432-2  
12P MTA156 CONN ASSY 20AWG YEL



## Also in the Series | MTA 156

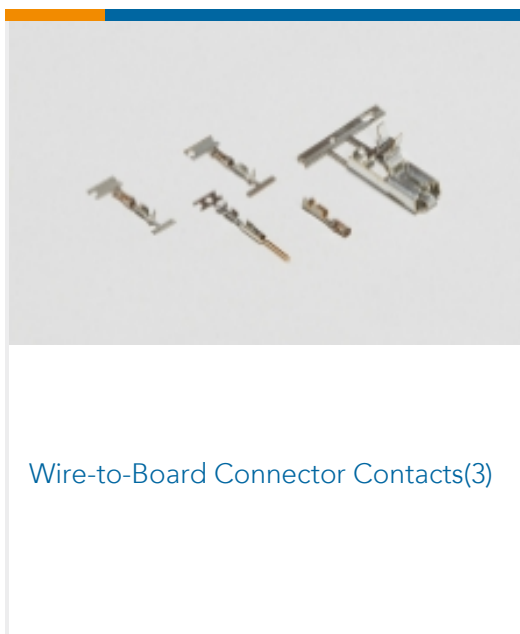
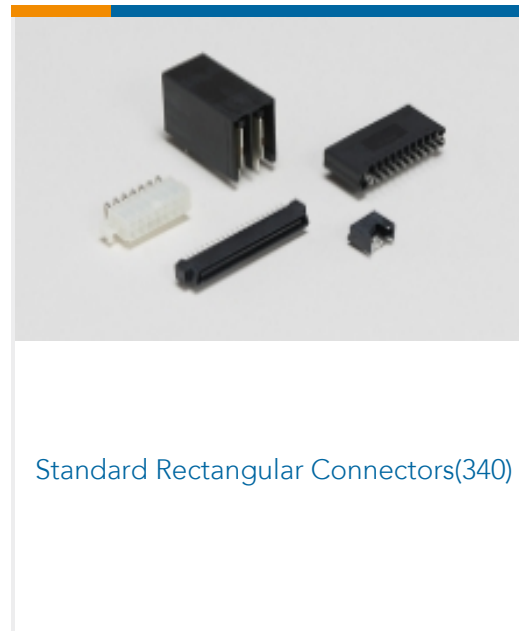
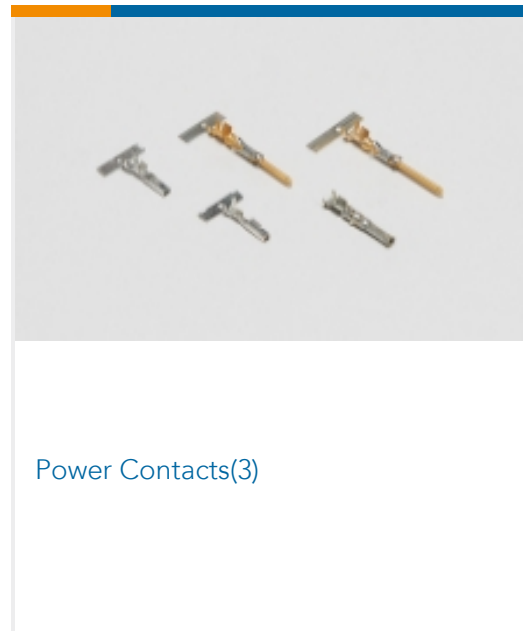
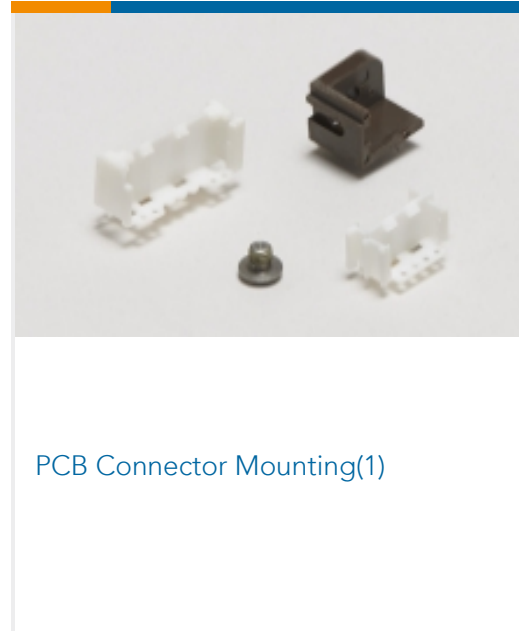
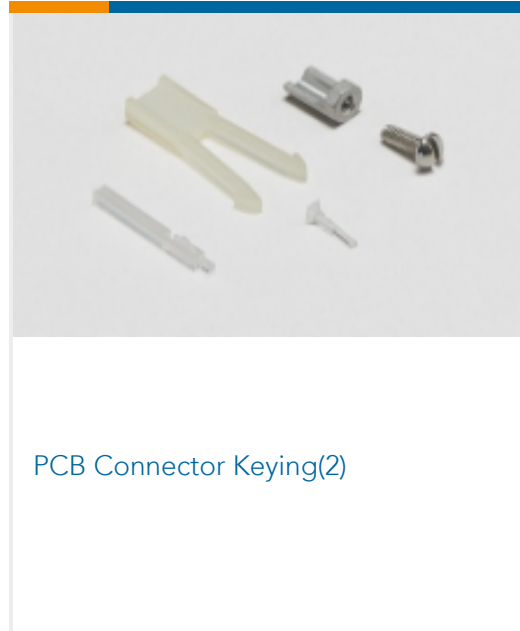
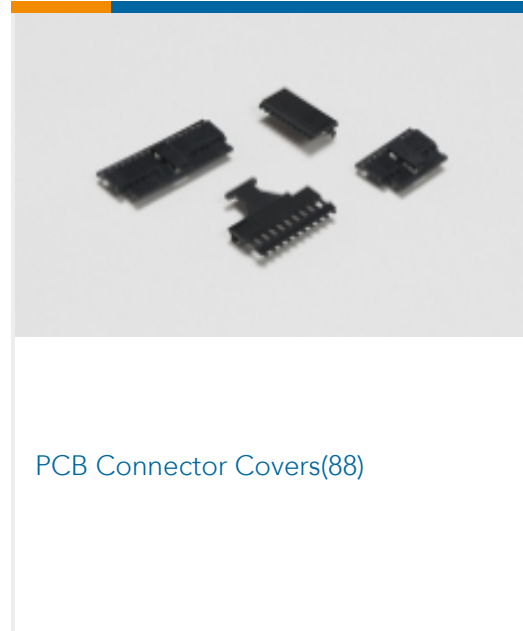
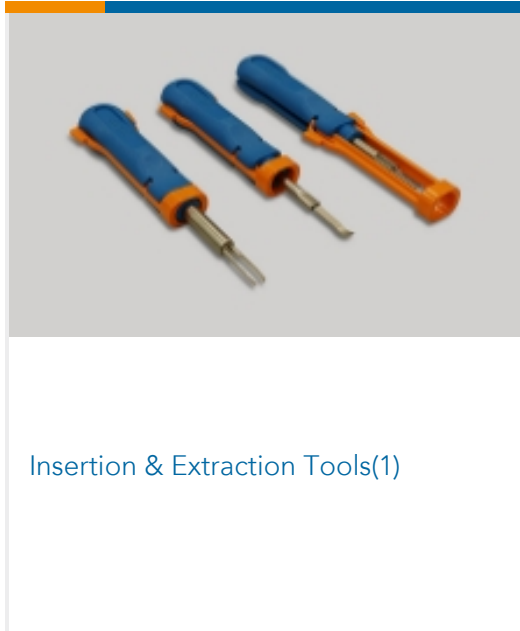

## Customers Also Bought



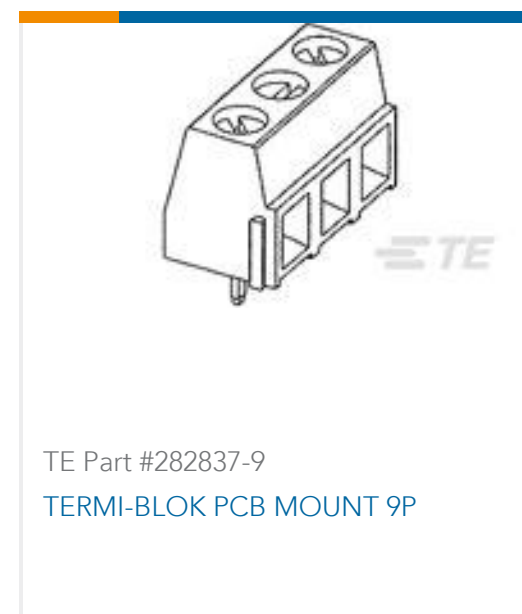

## Documents

### Product Drawings

[12P MTA156 HDR ASSY SQ STR F/L](#)

English

### CAD Files

[3D PDF](#)

3D

Customer View Model

[ENG\\_CVM\\_CVM\\_1-644752-2\\_E.2d\\_dxf.zip](#)

English

Customer View Model

[ENG\\_CVM\\_CVM\\_1-644752-2\\_E.3d\\_igs.zip](#)

English

Customer View Model

[ENG\\_CVM\\_CVM\\_1-644752-2\\_E.3d\\_stp.zip](#)

English

By downloading the CAD file I accept and agree to the [Terms and Conditions](#) of use.

### Product Specifications

[Application Specification](#)

English

### Product Environmental Compliance

[TE Material Declaration](#)

English

### Agency Approvals

[UL Report](#)

1-644752-2

Rectangular Power Connectors, Header, Plug, Wire-to-Board, 12 Position, 3.96 mm [.156 in] Centerline, Printed Circuit Board, UL 94V-0, MTA 156



English