

Deep UV LED - 405nm

Standard POB series

TCN0MA1A



Product Brief

Description

TCN0MA1A is a small UV module with peak emission wavelength at 405nm. The high power LED is encased in a protective silicone dome.

The attached circuit board makes this module useful for application development requiring adjustable device spacing, removable devices, and small scale testing.

Z5 NUV LED is an ideal UV light source for curing, printing, and detecting applications.

Features and Benefits

- Near ultraviolet LED
- Low thermal resistance
- SMT solderable
- Lead-free product
- RoHS compliant

Key Applications

- UV Curing
- Printing
- Coating
- Adhesive
- Counterfeit detection/security
- UV torches
- Fluorescence photography
- Dental curing
- Crime inspection
- Oil leak detection

Table of Contents

Index

- Product Brief
- Table of Contents
- Performance Characteristics
- Characteristics Graph
- Binning Structure
- Mechanical Dimensions
- Precaution for Use
- Company Information

Performance Characteristics

Table 1. Electro - Optical characteristic at 500mA

 (T_a=25°C, RH=30%)

Parameter	Symbol	Value	Unit
Peak Wavelength ^[1]	λ_p	405	nm
Radiant Flux ^[2]	Φ_e ^[3]	1160	mW
Forward Voltage ^[4]	V _F	3.5	V
Spectrum Half Width	$\Delta \lambda$	15	nm
View Angle	2 $\Theta_{1/2}$	120	deg.
Thermal Resistance (J to S) ^[5]	R θ_{J-S}	3.5	°C/W

Table 2. Absolute Maximum Rating

Parameter	Symbol	Value			Unit
		Min.	Typ.	Max.	
Forward Current	I _F	100	-	700	mA
Junction Temperature	T _j	-	-	90	°C
Operating Temperature ^[7]	T _{opr}	- 10	-	85	°C
Storage Temperature ^[7]	T _{stg}	- 40	-	100	°C

Notes :

1. Peak wavelength measurement tolerance: ± 3 nm
2. Optical Output Power measurement tolerance: ± 10%
3. Φ_e is the Optical Output Power as measured with an integrated sphere
4. Forward voltage measurement tolerance: ± 3%
5. R θ_{J-S} is the thermal resistance between chip junction and solder point

Characteristics Graph

Fig 1. Spectrum, $a=25^{\circ}\text{C}$, $I_F=500\text{mA}$

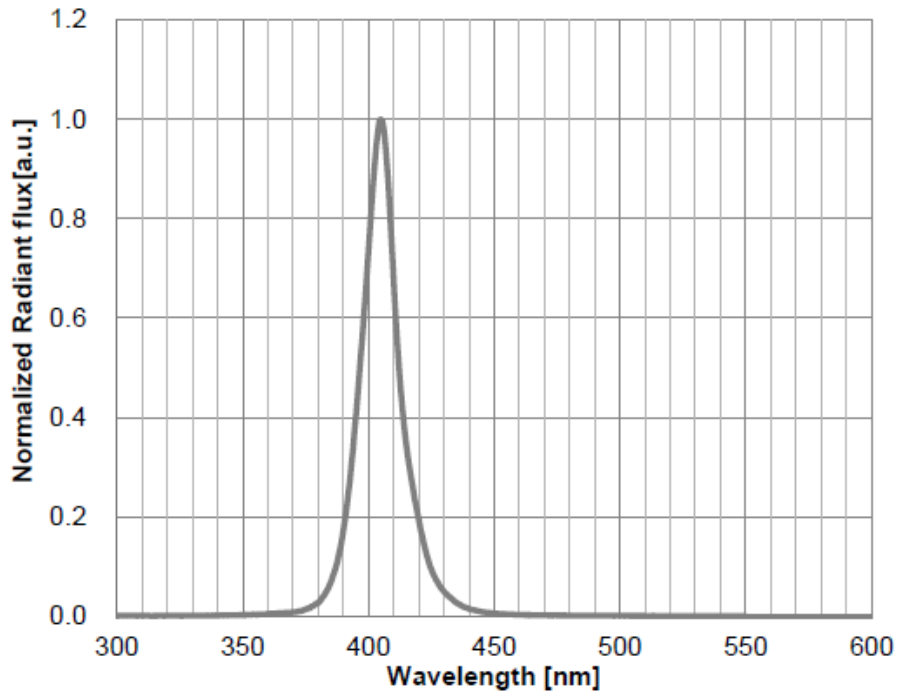
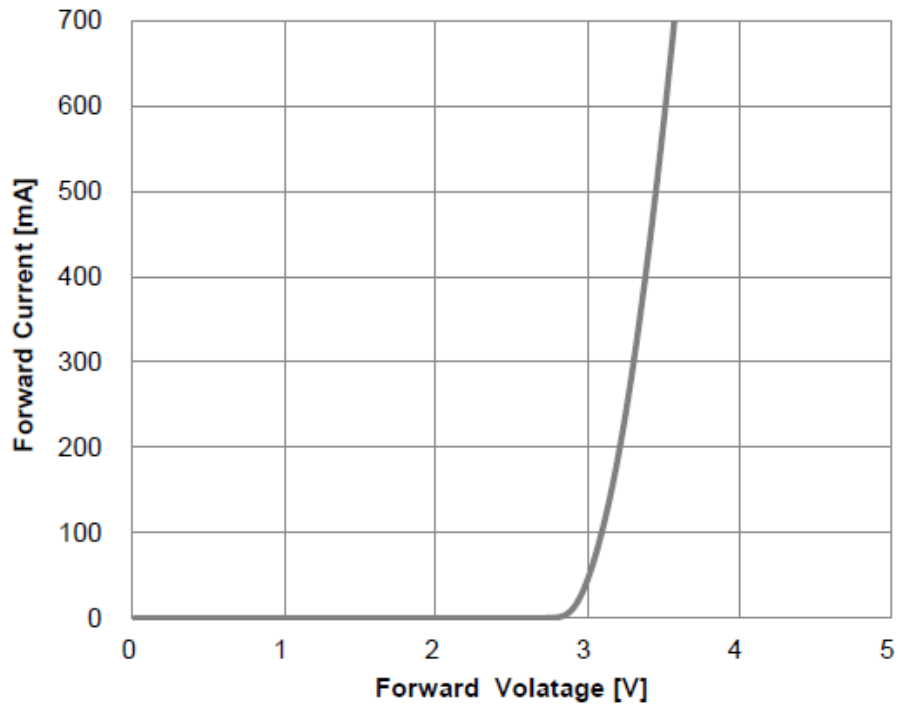

Fig 2. Forward Current vs. Forward Voltage, $T_a=25^{\circ}\text{C}$



Characteristics Graph

Fig 3. Relative Radiant Flux vs. Forward Current, $T_a=25^\circ\text{C}$

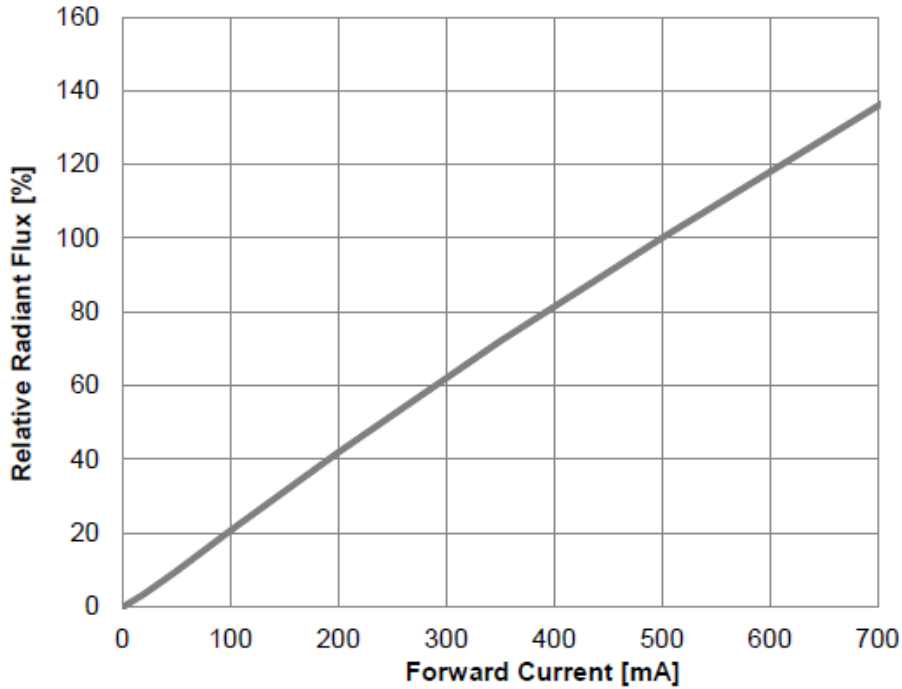
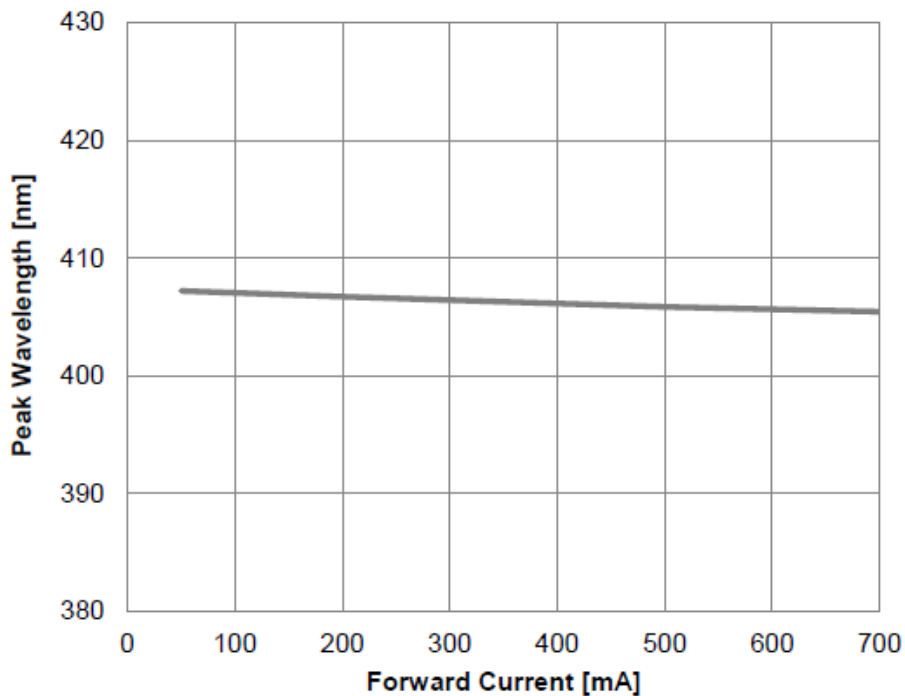

Fig 4. Peak Wavelength vs. Forward Current, $T_a=25^\circ\text{C}$



Characteristics Graph

Fig 5. Relative Radiant Flux vs. Ambient Temperature, $I_F=500mA$

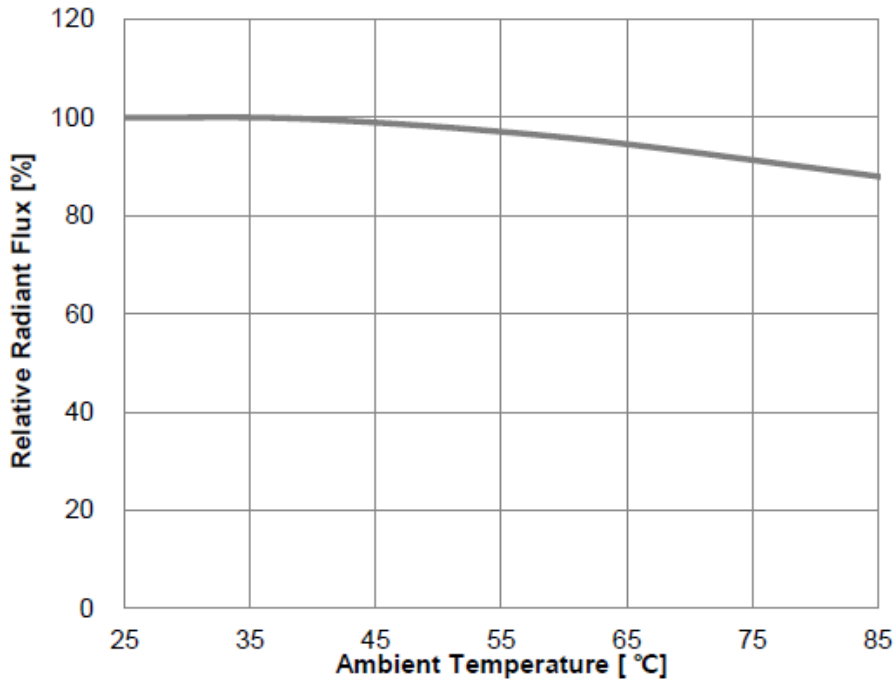
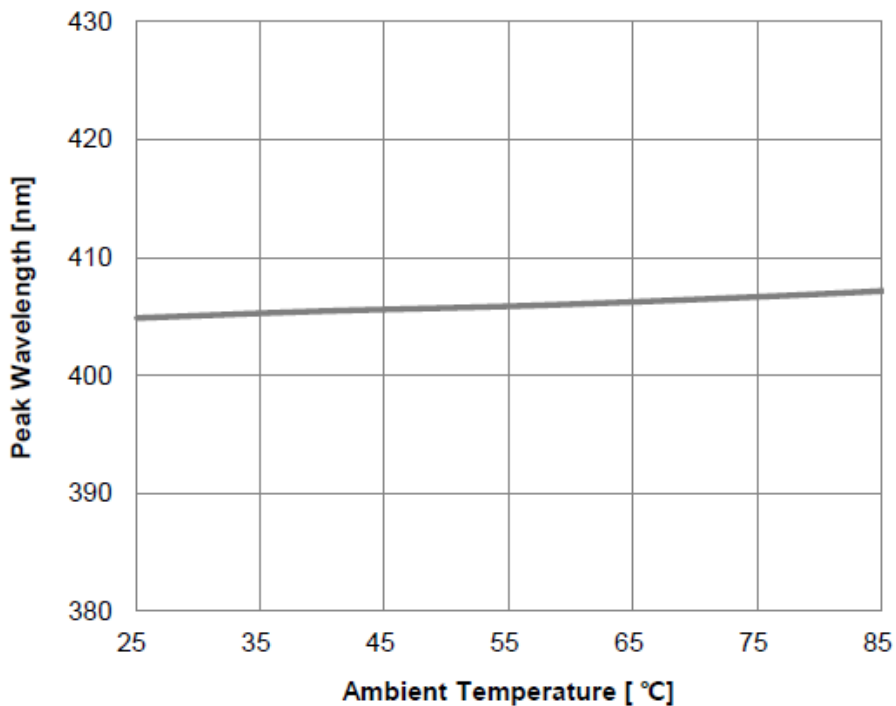

Fig 6. Peak Wavelength vs. Ambient Temperature, $I_F=500mA$



Characteristics Graph

Fig 7. Forward Voltage vs Ambient Temperature, $I_F=500mA$

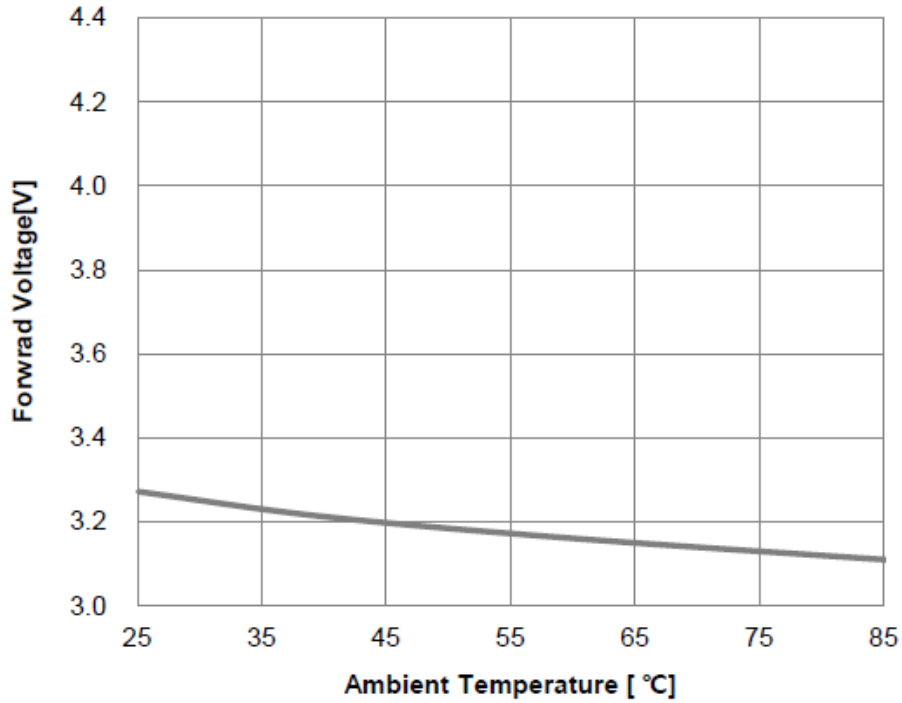
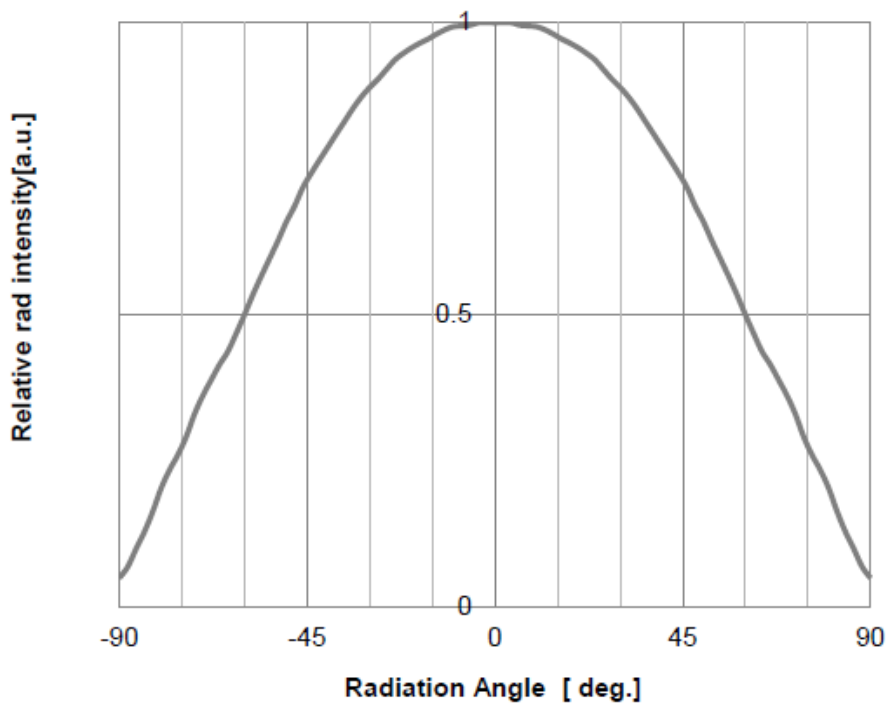
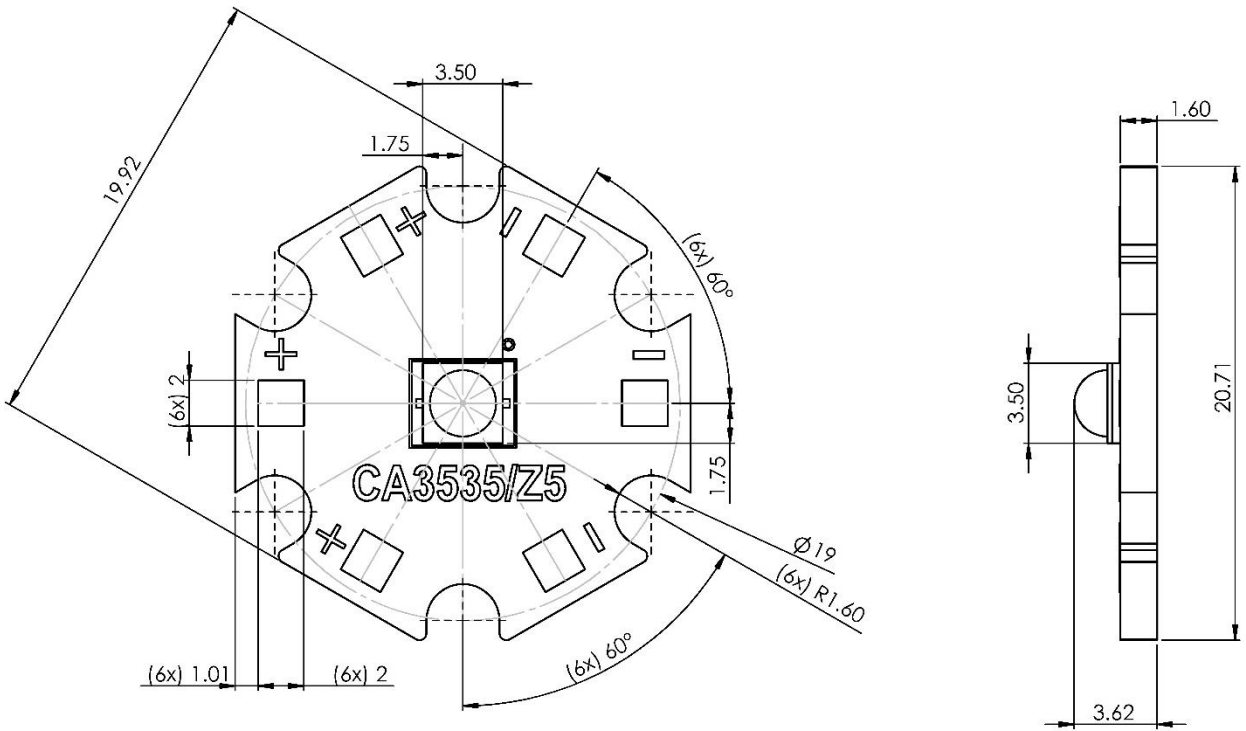

Fig 8. Typical Spatial Distribution, $I_F=500mA$



Mechanical Dimensions



Notes :

- [1] All dimensions are in millimeters
- [2] Not to scale
- [3] Undefined tolerances are $\pm 0.2\text{mm}$

Precaution for Use

A. UV Light

- These devices are ultraviolet LEDs. During operation, the LED emits high intensity ultraviolet (UV) light, which is harmful to skin and eyes. Do not look directly into the UV light and wear protective equipment during operation.
- UV light is hazardous to skin and may cause cancer. Avoid exposure to UV light when LED is operational.
- Precautions must be taken to avoid looking directly at the UV light without the use of UV light protective glasses. Do not look directly at the front of the LED or at the LED's lens when LED is operational.
- **Attach the following warning labels on products/systems that use UV LEDs.**



B. Static Electricity

- Electrostatic discharge (ESD) is defined as the release of static electricity when two objects come into contact. While most ESD events are considered harmless, it can be an expensive problem in many industrial environments during production and storage. The damage from ESD to an LEDs may cause the product to demonstrate unusual characteristics such as:
 - Increase in reverse leakage current lowered turn-on voltage
 - Abnormal emissions from the LED at low current
- The following recommendations are suggested to help minimize the potential for an ESD event.
- One or more recommended work area suggestions:
 - Ionizing fan setup
 - ESD table/shelf mat made of conductive materials
 - ESD safe storage containers
- One or more personnel suggestion options:
 - Antistatic wrist-strap
 - Antistatic material shoes
 - Antistatic clothes
- Environmental controls:
 - Humidity control (ESD gets worse in a dry environment)

Precaution for Use

C. Operating Conditions

- In order to ensure the correct functioning of these LEDs, compliance to the maximum electrical specifications is paramount. These LEDs are particularly sensitive to any current value that exceeds the absolute maximum rating of the product. Any applied current in excess of the maximum specification will cause damage and possible complete failure of the product.
- The current flowing in a LED is an exponential function of the voltage across it. A small change in voltage can produce a very large change in current and lead to complete failure of the LED. The use of current regulated drive circuits are recommended for these products.
- **Any attempt to drive these UV LEDs with a voltage source instead of a current source will cause damage and possible complete failure of the product.**
- These devices are not designed to be used under negative bias.
- This device is not to be used in any type of fluid such as water, oil, organic solvent, etc.
- These LEDs are susceptible to heat generation. Use care to design end product with adequate thermal management to ensure that LEDs do not exceed maximum recommended temperatures. Operating LEDs at temperatures in excess of specification will result in damage and possible complete failure of the product. When the LEDs are in operation the maximum current should be decided after measuring the package temperature.
- The driving circuit must be designed to allow forward voltage only when it is ON or OFF. If the reverse voltage is applied to LED, migration can be generated resulting in LED damage.
- EOS (Electrical Over Stress) – EOS is defined as damage that may occur when an electronic device is subjected to a current or voltage that is beyond the maximum specification limits of the device. The effects from an EOS event can be noticed through product performance like:
 - Changes to the performance of the LED package (If the damage is around the bond pad area and since the package is completely encapsulated the package may turn on but flicker or show severe performance degradation.)
 - Changes to the light output of the luminaire from component failure
 - Components on the board not operating at determined drive power
 - Failure of performance from an entire fixture due to changes in circuit voltage and current across total circuit causing trickle down failures.
- It is impossible to predict the failure mode of every LED exposed to electrical overstress as the failure modes vary significantly, but there are some common signs that will indicate an EOS event has occurred:
 - Damaged may be noticed to the bond wires (appearing similar to a blown fuse)
 - Damage to the bond pads located on the emission surface of the LED package (shadowing can be noticed around the bond pads while viewing through a microscope)
 - Anomalies noticed in the encapsulation and phosphor around the bond wires. This damage usually appears due to the thermal stress produced during the EOS event.

Precaution for Use

C. Operating Conditions - Continued

- To help minimize the damage from an EOS event Seoul Viosys recommends utilizing:
 - A surge protection circuit
 - An appropriately rated over voltage protection device
 - A current limiting device

D. Storage

- To avoid moisture penetration, we recommend storing UV LEDs in a dry box with a desiccant. The recommended temperature and relative humidity are between 5°C and 30°C and below 50% respectively.
- LEDs must be stored properly to maintain the device. If the LEDs are stored for 3 months or more after being shipped from SETI, a sealed container with a nitrogen atmosphere should be used for storage.
- Replace the remained LEDs into the moisture-proof bag and reseal the bag after work to avoid those LEDs being exposed to moisture. Prolonged exposure to moisture can adversely affect the performance of the LEDs.
- If the package has been open for more than 168hr or the color of the desiccant changes, components should be dried for 10-12hr at $60\pm 5^{\circ}\text{C}$.
- The conditions of resealing should be as follows: Temperature between 5 and 40°C and relative humidity less than 30%

E. Handling Precautions

- VOCs (Volatile organic compounds) emitted from materials used in the construction of fixtures can penetrate the LED packages and affect LED performance and lifetime. Knowledge of the properties of the materials selected to be used in the construction of fixtures can help prevent these issues.
- When attaching LEDs, do not use adhesives that outgas organic vapor.
- Soldering should be done as soon as possible after opening the moisture-proof bag.
- Do not rapidly cool device after soldering.
- Do not apply mechanical force or excess vibration during the cooling process to normal temperature after soldering.
- Components should not be mounted on warped (non coplanar) portions of a PCB.

Precaution for Use

E. Handling Precautions - Continued

- During processing, mechanical stress on the surface should be minimized as much as possible. Sharp objects of all types should not be used to pierce the sealing compound. Avoid touching glass lens parts especially with sharp tools such as tweezers

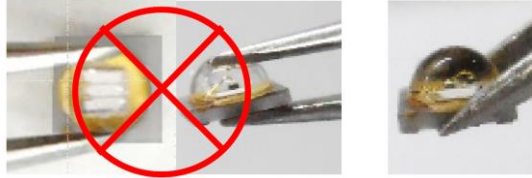

- In general, LEDs should only be handled from the side. This also applies to LEDs without a silicone sealant, since the surface can also become scratched.
- Silicone differs from materials conventionally used for the manufacturing of LEDs. These conditions must be considered during the handling of such devices. Compared to standard encapsulants, silicone is generally softer, and the surface is more likely to attract dust. As mentioned previously, the increased sensitivity to dust requires special care during processing. In cases where a minimal level of dirt and dust particles cannot be guaranteed, a suitable cleaning solution must be applied to the surface after the soldering of components.
- SVC suggests using isopropyl alcohol for cleaning. In case other solvents are used, it must be assured that these solvents do not dissolve the package or resin. Ultrasonic cleaning is not recommended. Ultrasonic cleaning may cause damage to the LED.
- Please do not mold this product into another resin (epoxy, urethane, etc) and do not handle this product with acid or sulfur material in sealed space.
- Avoid leaving fingerprints on silicone resin parts.

Company Information

Published by

Seoul Viosys © 2013 All Rights Reserved.

Company Information

Seoul Viosys (www.seoulviosys.com) manufactures light emitting diodes (LEDs) with a full range of UV wavelengths from UVC to UVA (under 400nm) for Industrial Curing, Air/Water Purification, Disinfection and Home appliance.

The company is one of the world leading UV LED supplier, holding more than 4,000 patents globally, while offering various kinds of LED technologies and application-solutions in High power UV LED, UV sensor, UV LED Lamp and variety of UV LED sourced Applications.

The company's broad product portfolio includes hybrid modules for unique applications such as UV disinfection, deodorization, UV purification as well as customized modules for your Application.

Legal Disclaimer

Information in this document is provided in connection with Seoul Viosys products. With respect to any examples or hints given herein, any typical values stated herein and/or any information regarding the application of the device, Seoul Viosys hereby disclaims any and all warranties and liabilities of any kind, including without limitation, warranties of non-infringement of intellectual property rights of any third party. The appearance and specifications of the product can be changed to improve the quality and/or performance without notice.