

5-179467-1 ✓ ACTIVE



Power Double Lock

TE Internal #: 5-179467-1

Rectangular Power Connectors, Housing, Cap, Wire-to-Wire, 8 Position, 3.96 mm [.156 in] Centerline, Wire & Cable, UL 94V-0, Power Double Lock

[View on TE.com >](#)

Connectors > Power Connectors > Rectangular Power > Rectangular Power Connectors > Glow Wire Power Double Lock Cap



Rectangular Power Connector Type: **Housing**

Connector & Housing Type: **Cap**

Connector System: **Wire-to-Wire**

Number of Positions: **8**

Centerline (Pitch): **3.96 mm [.156 in]**

[All Glow Wire Power Double Lock Cap \(35\)](#)

Features

Product Type Features

Rectangular Power Connector Type	Housing
Connector & Housing Type	Cap
Connector System	Wire-to-Wire
Sealable	No
Connector & Contact Terminates To	Wire & Cable

Configuration Features

Number of Positions	8
Number of Power Positions	8
Number of Signal Positions	0
Number of Rows	2

Electrical Characteristics

Operating Voltage	300 VAC
-------------------	---------



Contact Features

Contact Retention Within Housing	Without
Contact Type	Tab

Termination Features

Termination Method to Wire & Cable	Crimp
------------------------------------	-------

Mechanical Attachment

Connector Mounting Type	Cable Mount (Free-Hanging)
-------------------------	----------------------------

Housing Features

Centerline (Pitch)	3.96 mm [.156 in]
Housing Color	Natural
Housing Material	Nylon 6/6

Dimensions

Row-to-Row Spacing	4.6 mm [.181 in]
--------------------	------------------

Usage Conditions

Operating Temperature Range	-30 – 105 °C [-22 – 221 °F]
-----------------------------	-----------------------------

Operation/Application

Circuit Application	Power
---------------------	-------

Industry Standards

UL Flammability Rating	UL 94V-0
Glow Wire Rating	GWT 750°C (Without Flame)

Packaging Features

Packaging Quantity	100
Packaging Method	Bag

Product Compliance

[For compliance documentation, visit the product page on TE.com>](#)

EU RoHS Directive 2011/65/EU	Compliant
EU ELV Directive 2000/53/EC	Compliant
China RoHS 2 Directive MIIT Order No 32, 2016	No Restricted Materials Above Threshold
EU REACH Regulation (EC) No. 1907/2006	Current ECHA Candidate List: JUNE 2023 (235) Candidate List Declared Against: JAN 2023 (233)



Does not contain REACH SVHC

Halogen Content

Not Low Halogen - contains Br or Cl > 900 ppm.

Solder Process Capability

Not reviewed for solder process capability

Product Compliance Disclaimer

This information is provided based on reasonable inquiry of our suppliers and represents our current actual knowledge based on the information they provided. This information is subject to change. The part numbers that TE has identified as EU RoHS compliant have a maximum concentration of 0.1% by weight in homogenous materials for lead, hexavalent chromium, mercury, PBB, PBDE, DBP, BBP, DEHP, DIBP, and 0.01% for cadmium, or qualify for an exemption to these limits as defined in the Annexes of Directive 2011/65/EU (RoHS2). Finished electrical and electronic equipment products will be CE marked as required by Directive 2011/65/EU. Components may not be CE marked. Additionally, the part numbers that TE has identified as EU ELV compliant have a maximum concentration of 0.1% by weight in homogenous materials for lead, hexavalent chromium, and mercury, and 0.01% for cadmium, or qualify for an exemption to these limits as defined in the Annexes of Directive 2000/53/EC (ELV). Regarding the REACH Regulation, the information TE provides on SVHC in articles for this part number is based on the latest European Chemicals Agency (ECHA) 'Guidance on requirements for substances in articles' posted at this URL: <https://echa.europa.eu/guidance-documents/guidance-on-reach>

Compatible Parts



TE Part # 177902-1
AMP POWER DBL LOCK PLUG HSG 8P



TE Part # 177920-1
POWER DBL LOCK PLATE 3.96MM 4POS



TE Part # CAT-P87024-R2435
Power Double Lock Receptacle



TE Part # CAT-P87024-T111
Power Double Lock Tab

Also in the Series | Power Double Lock



Connector Contacts(1)



Insertion & Extraction Tools(2)



Power Contacts(23)



Rectangular Connector Locking(14)



Rectangular Power Connectors(284)

Customers Also Bought

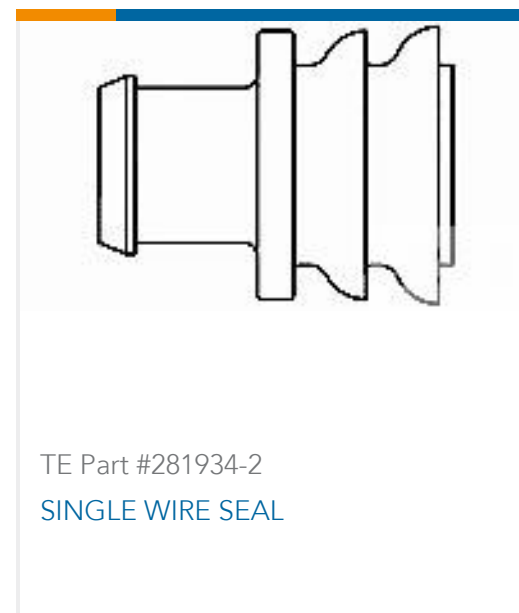
TE Part #206070-8
CABLE CLAMP KIT #17TE Part #DT04-2P
REC, 2P, GRY, NTE Part #DT06-2S
PLG, 2P, GRY, NTE Part #W2P
Wedgelocks: DEUTSCH DTTE Part #0462-201-16141
DEUTSCH Solid ContactsTE Part #282104-1
AMP SUPERSEAL 1.5MM,
CONNECTOR HOUSINGTE Part #281934-2
SINGLE WIRE SEAL

Documents

Product Drawings

[AMP POWER DBL LOCK CAP HSG 8P\(GWT\)](#)

English

CAD Files

[3D PDF](#)

3D

Customer View Model

[ENG_CVM_CVM_5-179467-1_N.2d_dxf.zip](#)

English

Customer View Model

[ENG_CVM_CVM_5-179467-1_N.3d_igs.zip](#)

English

Customer View Model

[ENG_CVM_CVM_5-179467-1_N.3d_stp.zip](#)

English

By downloading the CAD file I accept and agree to the [Terms and Conditions](#) of use.



Product Specifications

Application Specification

English

Instruction Sheets

Instruction Sheet (non U.S.)

English

AMP POWER DOUBLELOCK CONNECTOR SERIES

English

Agency Approvals

CSA Certificate

English