



IMPACT[®]

Features and Benefits

- Standard Color – light gray with a high gloss finish
- Best material – bases, opaque covers and clear covers are all made of high-impact, UV resistant polycarbonate
- Easy ordering – One part number equals one completely assembled enclosure
- Super easy use – mounting flanges integral, so no extra hardware needed
- Flexible Interior Mounting – bosses on rear wall and lid of opaque enclosure provide multiple mounting options for din rail, back panels, or other components
- Advanced face plate mounting system – Brand new completely unique and easy
- Secure – Choose your level of protection: pad lockable, tamper screw or tamper tag capable
- Frequency Friendly – Available with absolutely no metals of any kind on the enclosure which is extremely favorable for sending and receiving wireless signals
- UL-50 / c-UL Listed (file # E207562)

Our Impact[®] Line enclosures are the most versatile, feature packed, aesthetically pleasing, NEMA UL rated, non-metallic enclosures available. Features like extremely durable, UV resistant, wide temperature range, easy to machine, lighter than other non-metallic or metal materials, the “Made in USA” Impact[®] Line enclosures provide great value to any application.

Mechanical and Thermal Test Spec.	Unit	Impact [®] Line
Instrumented Dart Impact @ 73° F	in/lb.	565
Falling Ball Impact @ 73° F	UL-746 in/lb.	900
Deflection Temperature @ 264 psi	ASTM D648 Deg. F	270
Modulus of Elasticity	ASTM D790 ksi	340
Temperature Range	Deg. F	-40 to 265



Flammable / UV Ratings	Test Spec.	Unit	Impact [®] Line
Flame Rating - UL	UL 94	-	5VA
Outdoor UV Exposure	UL	-	f1

6063 P/N	4X IP66	6P IP68	Clear Cover	Opaque Cover	Integrated Mounting Flange	Standard Hinge	Low Profile Hinge	Integrated Locking Latch	Stainless Steel Locking Latch	Non-Metallic Locking Latch	Face Plate Mtg System*
P6063	✓	✓		✓	✓	✓		✓			✓
P6063C	✓	✓	✓		✓	✓		✓			✓
P6063LL	✓			✓	✓	✓			✓		✓
P6063CLL	✓		✓		✓	✓			✓		✓
P6063LP	✓	✓		✓	✓		✓	✓			✓
P6063LPC	✓	✓	✓		✓		✓	✓			✓
P6063LPLL	✓			✓	✓		✓		✓		✓
P6063LPCLL	✓		✓		✓		✓		✓		✓
P6063NL	✓			✓	✓	✓				✓	✓
P6063CNL	✓		✓		✓	✓				✓	✓
P6063LPNL	✓			✓	✓		✓			✓	✓
P6063LPCNL	✓		✓		✓		✓			✓	✓

* Sold separately





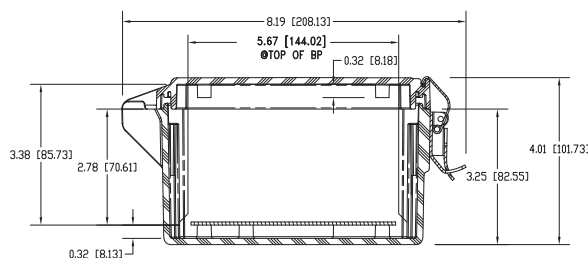
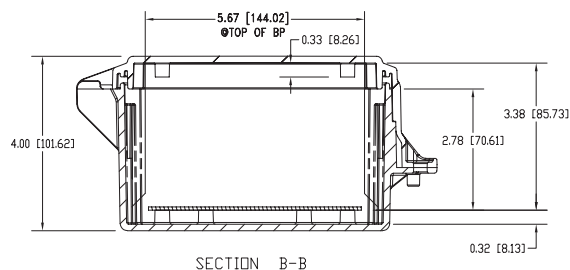
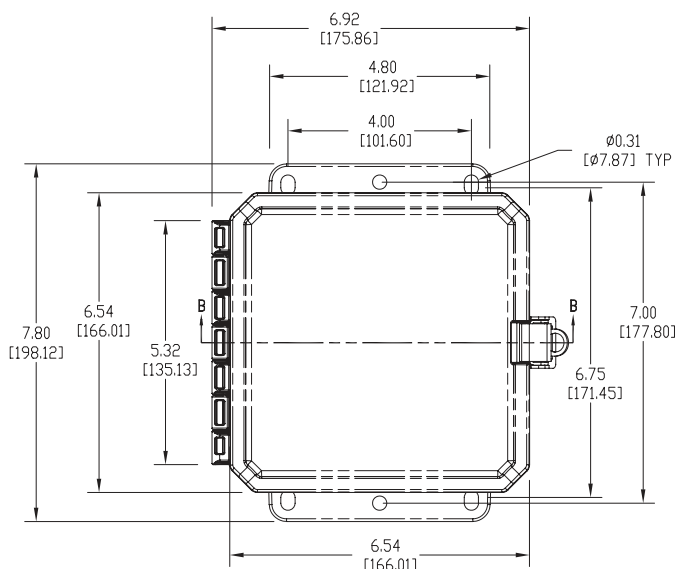
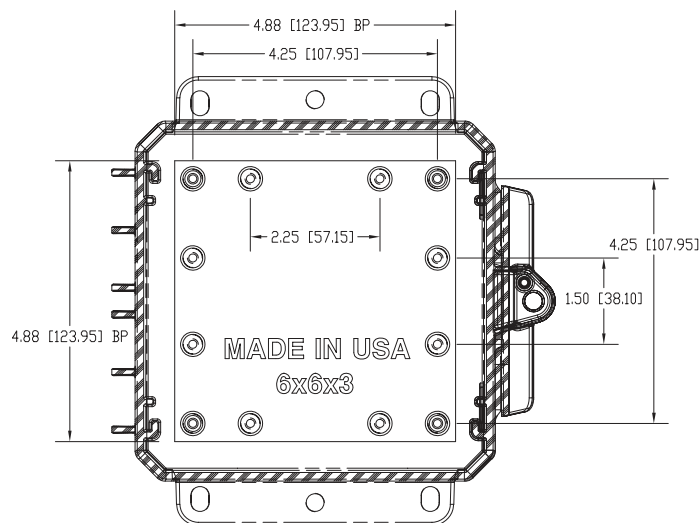
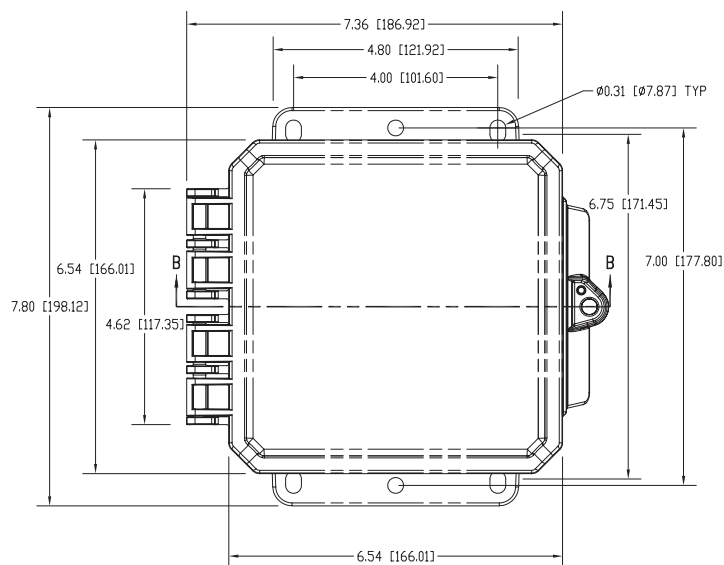



6X6X3 IMPACT® LINE

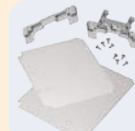

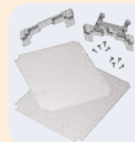
Register online to download this drawing off the Integra website at www.integraenclosures.com | Your company's logo or other information on the lid. Consult factory for details.

Accessories for 6x6x3 Impact® (For complete accessories, see pages 78-81)

 <p>Back Panels ABP66-IMP - Aluminum panel SBP66-IMP - Steel panel PVCBP66-IMP - PVC panel</p>	 <p>Aluminum Swing Out System ASWPK66-IMP Aluminum swing panel and SOPK-IMP mounting kit ASWP66-IMP - Aluminum swing panel only SOPK66/86-IMP - 2 rigid brackets, 1 pivot bracket & 8 self-tapping screws</p>	 <p>Aluminum Face Plate System AFP66-IMP - Aluminum face plate and SOPK-IMP mounting kit AFP66-IMP - Aluminum face plate only SOPK66/86-IMP - 2 rigid brackets, 1 pivot bracket & 8 self-tapping screws</p>
 <p>Air Vents VENT 3 - Aluminum louvered VENT 2 - Outdoor labyrinth</p>	 <p>Steel Swing Out System SSWPK66-IMP Steel swing panel and SOPK-IMP mounting kit SSWP66-IMP - Steel swing panel only SOPK66/86-IMP - 2 rigid brackets, 1 pivot bracket & 8 self-tapping screws</p>	 <p>Steel Face Plate System SFPK66-IMP - Steel face plate and SOPK-IMP mounting kit SFP66-IMP - Steel face plate only SOPK66/86-IMP - 2 rigid brackets, 1 pivot bracket & 8 self-tapping screws</p>
 <p>Din Rail DIN 6-IMP - 2 rails, 4 screws</p>	 <p>Pole Mounting Kit PMKG-26-IMP - 2" pole PMKG-36-IMP - 3" pole PMKG-46-IMP - 4" pole PMKG-126-IMP - 12" pole</p>	 <p>Cord Grips IP68/NEMA 4X/6P rated See page 72 for more details.</p>