

APPROVED: _____
 DATE: _____ TITLE: _____

Rev	AWO #	Description	Date	Appr
-		RELEASED	1/18/19	
A		UPDATED DRAW	3/11/19	AY/TW

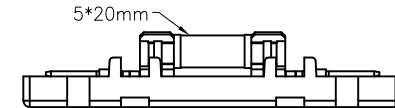
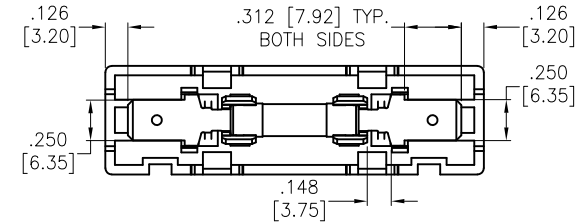
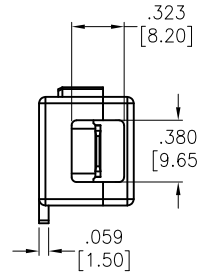
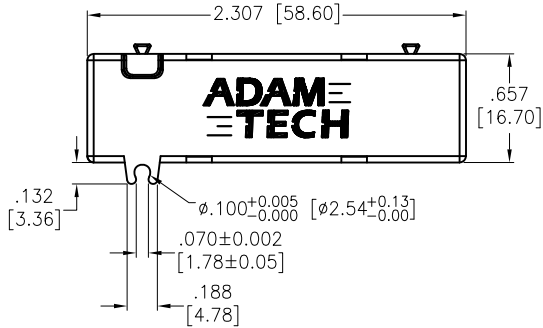
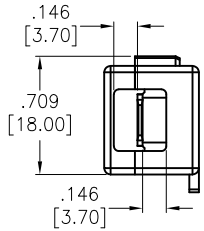
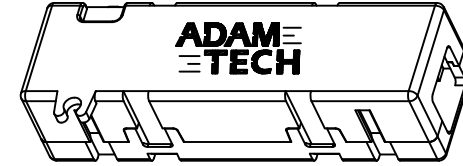
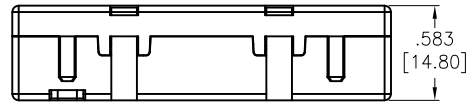

Bottom Cover and Terminal

FH-A-A01
 (1) (2) (3)(4)
 (1). SERIES NO.
 (2). TYPE
 (3). CONTACT TYPE
 A=.250" [6.35mm]
 (4). FUSE TYPE
 01=5x20

SPECIFICATIONS:

Material:
 Insulator: Thermoplastic, rated UL94V-0
 Insulator color: Black (Top and Bottom)
 Contact: Phosphor Bronze, Tin plated
 Fuse: 5x20mm, 250V, 3 Amp
 Temperature Rating:
 Operating temperature: -20°C to +70°C
 Environmental:
 Lead free, RoHS compliant.



UNLESS OTHERWISE SPECIFIED
 ALL DIMENSIONS ARE INCHES [MM]
 TOLERANCES: EXCEPT AS NOTED

INCHES		HOLES	
.X	±.10	∅.X	±.10
.XX	±.020	∅.XX	±.015
.XXX	±.015	∅.XXX	±.010

ADAM TECH
 INTERCONNECTS

909 Rahway Avenue,
 Union, NJ 07083
 Phone: 908-687-5000
 Fax: 908-687-5710

APPROVALS		DATE	TITLE	
DRAWN	AY	1/18/19	FUZE HOLDER, .250" QD 5X20 FUSE, 250V 3 Amp	
CHECKED	TW	1/18/19	SIZE	PART NO.
APPROVED			X	FH-A-A01B
			REV.	A
REF:		S00181C	SCALE:	NTS
			SHEET 1 OF 1	