

TINA2-M

~30° medium beam optimized for Nichia NS6x83.
Assembly with holder and installation tape.

SPECIFICATION:

Dimensions	Ø 16.1 mm
Height	11 mm
Fastening	tape
ROHS compliant	yes ⓘ



MATERIALS:

Component	Type	Material	Colour	Finish
TINA2-M	Single lens	PMMA	clear	
TINA2-HLD-N83-BLK	Holder	PC	black	
TINA-TAPE3	Tape	Acrylic foam	black	

ORDERING INFORMATION:

Component	Type	Qty in box	MOQ	MPQ	Box weight (kg)
CA11174_TINA2-M	Single lens	4140	230	230	8.4
» Box size: 451 x 241 x 298 mm					

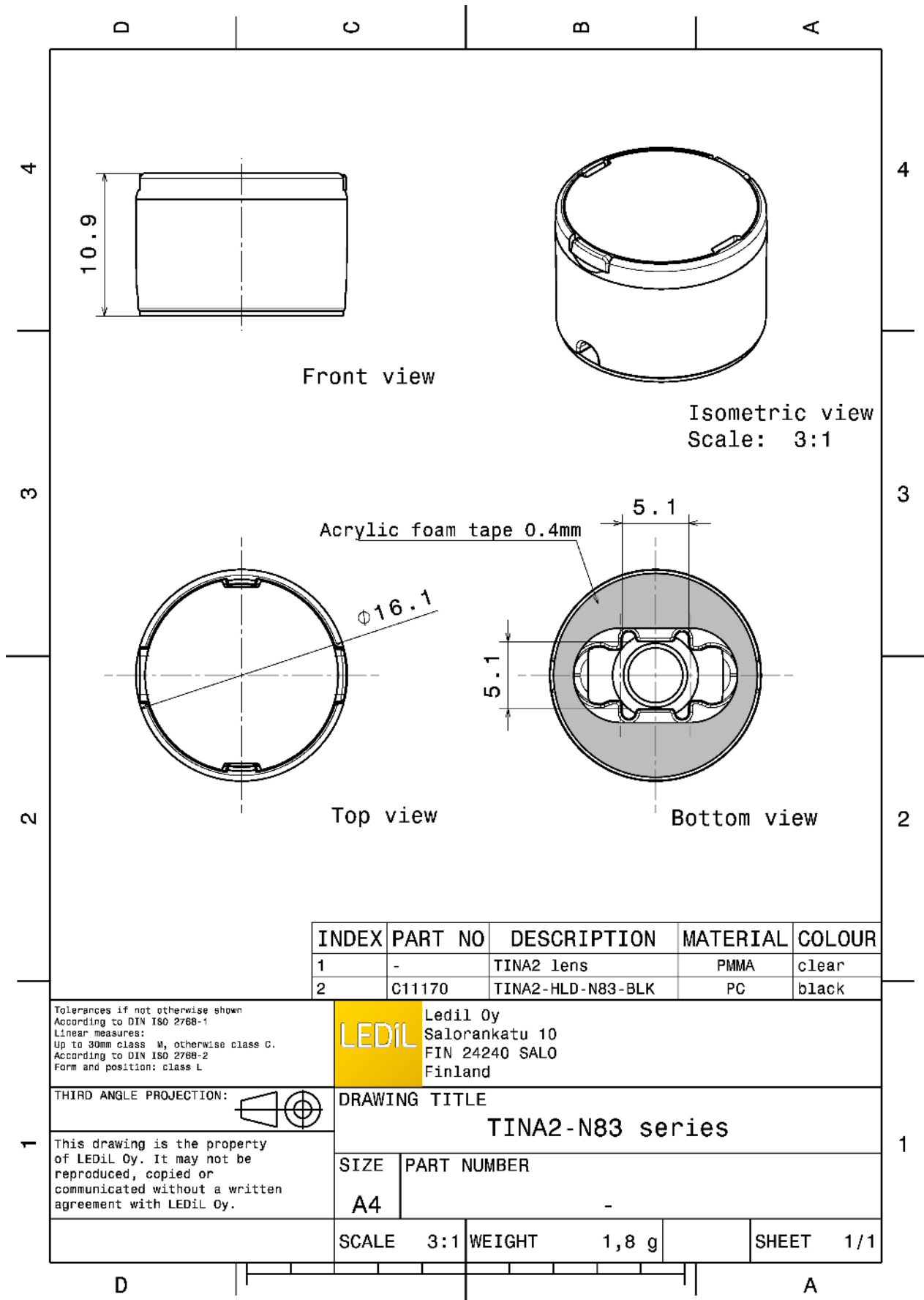

INDEX	PART NO	DESCRIPTION	MATERIAL	COLOUR
1	-	TINA2 lens	PMMA	clear
2	C11170	TINA2-HLD-N83-BLK	PC	black

Tolerances if not otherwise shown
According to DIN ISO 2768-1
Linear measures:
Up to 30mm class M, otherwise class C.
According to DIN ISO 2768-2
Form and position: class L



Ledil Oy
Salorankatu 10
FIN 24240 SALO
Finland

THIRD ANGLE PROJECTION:

DRAWING TITLE
TINA2-N83 series

This drawing is the property of LEDiL Oy. It may not be reproduced, copied or communicated without a written agreement with LEDiL Oy.

SIZE	PART NUMBER
A4	-

SCALE	3:1	WEIGHT	1,8 g	SHEET	1/1
-------	-----	--------	-------	-------	-----

See also our general installation guide: www.ledil.com/installation_guide

OPTICAL RESULTS (MEASURED):

CREE LED

LED MX-6
 FWHM / FWTM 30.0° / 60.0°
 Efficiency 83 %
 Peak intensity 2.2 cd/lm
 LEDs/each optic 1
 Light colour White
 Required components:

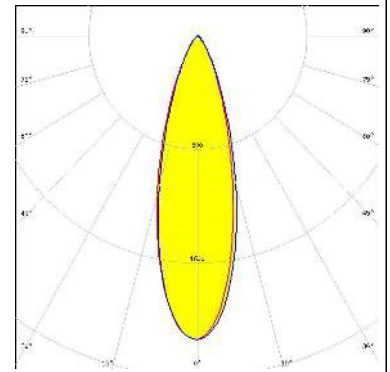

LUMILEDS

LED LUXEON 5050 Round LES
 FWHM / FWTM 34.0° / 69.0°
 Efficiency 78 %
 Peak intensity 1.6 cd/lm
 LEDs/each optic 1
 Light colour White
 Required components:

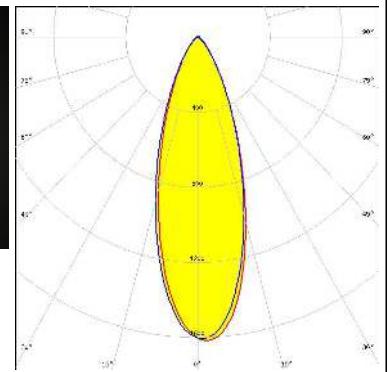
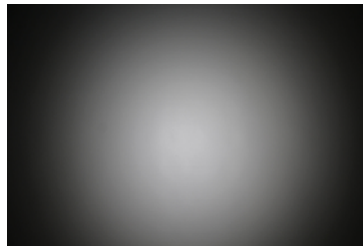

LUMILEDS

LED LUXEON V
 FWHM / FWTM 32.0° / 63.0°
 Efficiency 75 %
 Peak intensity 1.9 cd/lm
 LEDs/each optic 1
 Light colour White
 Required components:

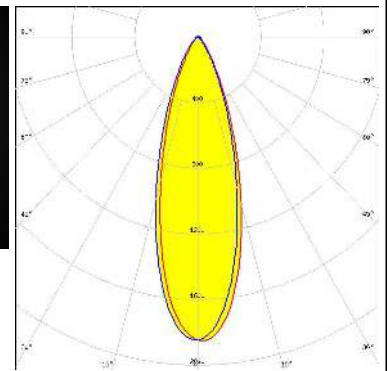
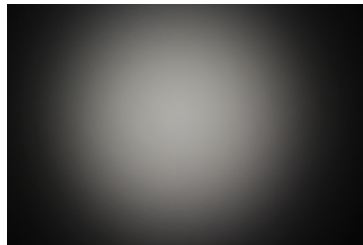

NICHIA





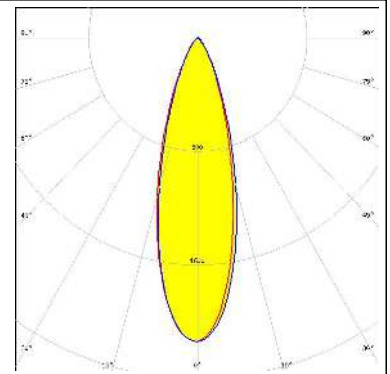
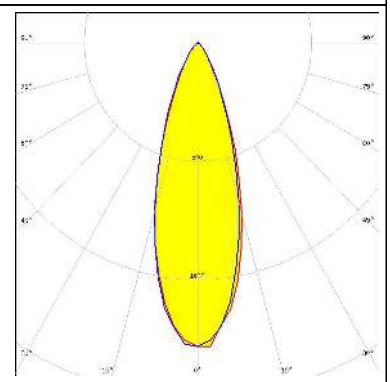
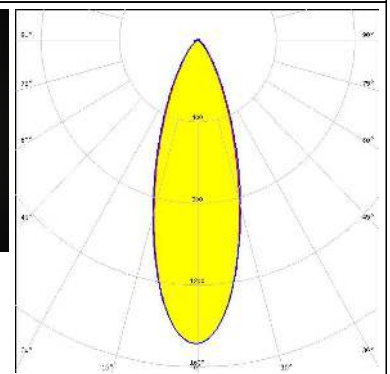

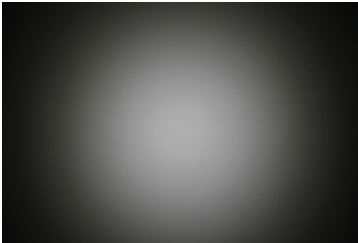
LED NS3x83
 FWHM / FWTM 32.0° / 60.0°
 Efficiency %
 Peak intensity 2.2 cd/lm
 LEDs/each optic 1
 Light colour White
 Required components:

OPTICAL RESULTS (MEASURED):

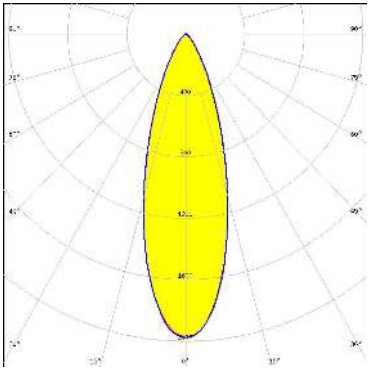

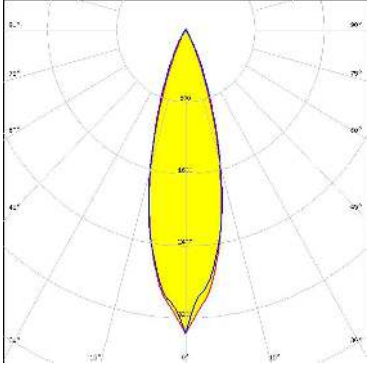

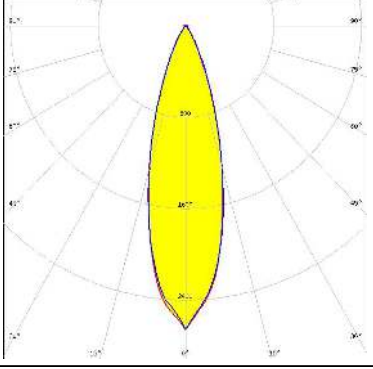

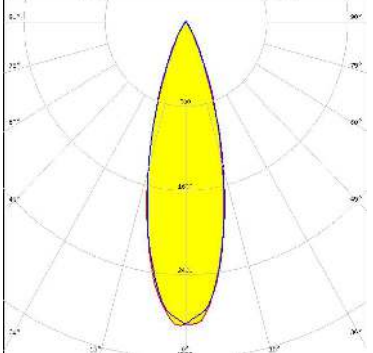
<p>NICHIA</p> <p>LED NS6x83 FWHM / FWTM 30.0° / 60.0° Efficiency 85 % Peak intensity 2.3 cd/lm LEDs/each optic 1 Light colour White Required components:</p>	
<p>OPTOGAN</p> <p>LED OLP-x5050F6L FWHM / FWTM 34.0° / 64.0° Efficiency 86 % Peak intensity 2.1 cd/lm LEDs/each optic 1 Light colour White Required components:</p>	
<p>SAMSUNG</p> <p>LED LH508A FWHM / FWTM 33.0° / 68.0° Efficiency 71 % Peak intensity 1.5 cd/lm LEDs/each optic 1 Light colour White Required components:</p>	

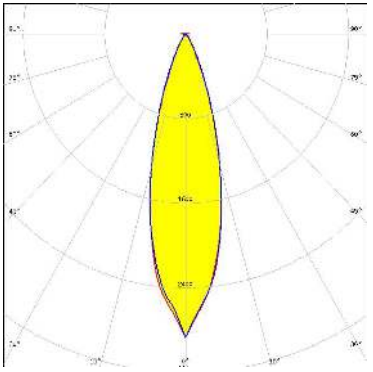

OPTICAL RESULTS (SIMULATED):

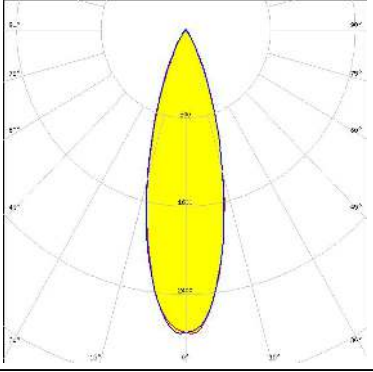
	<p>LED J Series 5050 Round LES FWHM / FWTM 32.0° / 65.0° Efficiency 83 % Peak intensity 2 cd/lm LEDs/each optic 1 Light colour White Required components:</p>	
	<p>LED XP-E2 FWHM / FWTM 28.0° / 51.0° Efficiency 90 % Peak intensity 3.4 cd/lm LEDs/each optic 1 Light colour White Required components:</p>	
	<p>LED XP-G3 FWHM / FWTM 30.0° / 56.0° Efficiency 84 % Peak intensity 2.7 cd/lm LEDs/each optic 1 Light colour White Required components:</p>	
	<p>LED XP-L HI FWHM / FWTM 30.0° / 54.0° Efficiency 89 % Peak intensity 2.9 cd/lm LEDs/each optic 1 Light colour White Required components:</p>	

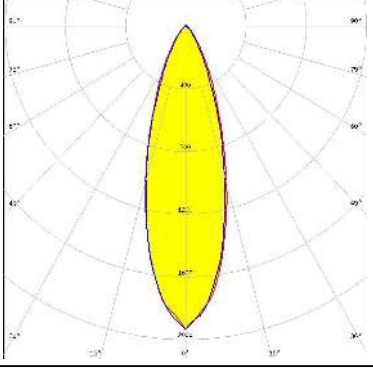
OPTICAL RESULTS (SIMULATED):

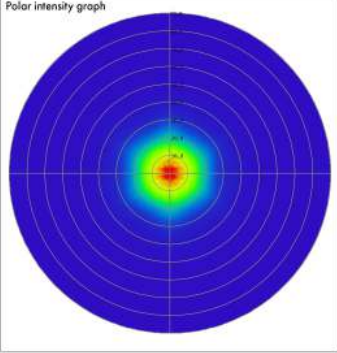
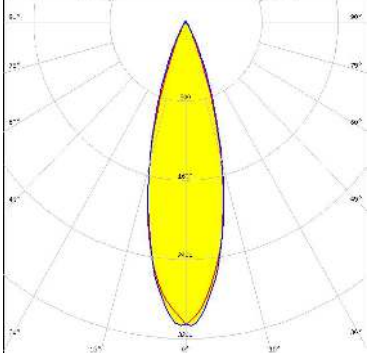
	<p>LED XT-E FWHM / FWTM 28.0° / 52.0° Efficiency 81 % Peak intensity 2.9 cd/lm LEDs/each optic 1 Light colour White Required components:</p>		
	<p>LED NVSW219F FWHM / FWTM 30.0° / 55.0° Efficiency 88 % Peak intensity 2.8 cd/lm LEDs/each optic 1 Light colour White Required components:</p>		
	<p>LED Duris S8 FWHM / FWTM 31.0° / 65.0° Efficiency 78 % Peak intensity 1.9 cd/lm LEDs/each optic 1 Light colour White Required components:</p>		
	<p>LED SFH 4715AS FWHM / FWTM 29.0° / 50.0° Efficiency 87 % LEDs/each optic 1 Light colour IR Required components:</p>		

GENERAL INFORMATION:

NOTE: The typical beam angle will be changed by different color, chip size and chip position tolerance. The typical total beam angle is the full angle measured where the luminous intensity is half of the peak value.

MATERIALS:

As part of our continuous research and improvement processes, and to ensure the best possible quality and availability of our products, LEDiL reserves the right to change material grades without notice.

PRODUCT DATA USER AGREEMENT AND DISCLAIMER:

The measured data in the provided downloadable LEDiL Product Datasheets and Mechanical 2D-Drawings is rounded and provided as reference for planning. LEDiL Oy's optical specifications have been verified by conducting performance testing of the products in accordance with the company's quality system. The reported data are averaged results of multiple measurements with typical variation. LEDiL Oy reserves the right to without prior notification make changes and improvements to its products.

LEDiL Oy assumes neither warranty, nor guarantee nor any other liability of any kind for the contents and correctness of the provided data. The provided data has been generated with highest diligence but the provided data may in reality not represent the complete possible variation range of all intrinsic parameters. Therefore, in certain cases a deviation from the provided data could occur.

LEDiL Oy reserves the right to undertake technical changes of its products without further notification which could lead to changes in the provided data. LEDiL Oy assumes no liability of any kind for the possible deviation from any provided data or any other damage resulting from the usage of the provided data.

The user agrees to this disclaimer and user agreement with the download or usage of the provided files.

LEDiL Oy

Joensuunkatu 13
FI-24240 SALO
Finland

LEDiL Inc.

228 West Page Street
Suite D
Sycamore IL 60178
USA

Ledil Optics Technology (Shenzhen) Co., Ltd.

405 , Block B
Casic Motor Building
Shenzhen 518057
P.R.CHINA

Local sales and technical support

[www.ledil.com/
where_to_buy](http://www.ledil.com/where_to_buy)

Shipping locations

Salo, Finland
Hong Kong, China

Distribution Partners

[www.ledil.com/
where_to_buy](http://www.ledil.com/where_to_buy)