

SPECIFICATIONS

CUSTOMER	:	CNO003
SAMPLE CODE	:	SNA800480T030-ZHC
MASS PRODUCTION CODE	:	HNA800480T030-ZHC
SAMPLE VERSION	:	01
SPECIFICATIONS EDITION	:	003
DRAWING NO. (Ver.)	:	LMD-HNA800480T030-ZHC (Ver.002)
PACKAGING NO. (Ver.)	:	PKG-HNA800480T030-ZHC (Ver.001)

Customer Approved

Date:

Approved	Checked	Designer
林裘中 Daniel Lin	呂清溪 Marc Lu	王映喻 Brown Wang

- Preliminary specification for design input
- Specification for sample approval

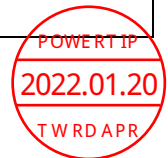

POWERTIP TECH. CORP.

Headquarters: No.8, 6 th Road, Taichung Industrial Park, Taichung, Taiwan 台中市 407 工業區六路 8 號	TEL: 886-4-2355-8168 FAX: 886-4-2355-8166	E-mail: sales@powertip.com.tw Http://www.powertip.com.tw
---	--	--

History of Version

Date (mm / dd / yyyy)	Ver.	Edi.	Description	Page	Design by
04/01/2021	01	001	Preliminary	-	Brown
04/09/2021	01	002	Modify 2.2 Interface Pin Description	10~11	Brown
01/14/2022	01	003	1. First Sample 2. Modify 1.4 Power Supply & Current Power Consumption 3. Modify 4.1 High Temperature Storage Test 4. Modify 4.1 Low Temperature Storage Test 5. Modify 4.1 High Temperature/High Humidity Storage Test 6. Modify LCM Drawing 7. Add Packaging Specification	- 5 14 14 14 Appendix Appendix	Brown

Contents

1. SPECIFICATIONS

- 1.1 Features
- 1.2 Mechanical Specifications
- 1.3 Absolute Maximum Ratings
- 1.4 DC Electrical Characteristics
- 1.5 Optical Characteristics

2. MODULE STRUCTURE

- 2.1 Counter Drawing
- 2.2 Interface Pin Description

3. QUALITY ASSURANCE SYSTEM

- 3.1 Quality Assurance Flow Chart

4. RELIABILITY TEST

- 4.1 Reliability Test Condition

5. PRECAUTION RELATING PRODUCT HANDLING

- 5.1 Safety
- 5.2 Handling
- 5.3 Storage
- 5.4 Terms of Warranty

Appendix :

- 1.LCM Drawing
- 2.Packaging Specification

1. SPECIFICATIONS

1.1 Features

Hardware

CPU	RISC Processor	N32926 (ARM926EJ-S) 64MB DDR2 SDRAM
Memory	On Board Flash	1Gb NAND Flash 4GB eMMC (Option)
	External Storage	1x Micro SD (max. 32G)
Display	Resolution	800 x 480 (16bits RGB)
	Touch Panel	Projected Capacitive Touch
	Interface	Parallel RGB 16 bits
I/O	USB	1x USB2.0 Device
	Serial	1 x UART
Power Input	DC	5.0V

Note1:

1. Memory type (Option) will be setting by customer's request.
2. Touch Panel Type will be setting by customer's request.
3. Support PWM Signal Output. (5kHz, Duty Cycle: 256 Step)
4. Support JPEG Codec.
5. Support H.264 & MJPEG Codec
6. Support Video Data Processor (VPE)
7. Support RTC

Note2:

This product built-in Powertip communication protocol system firmware. It manipulates the GUI contents that generated by Powertip Graphic Editor software.(support maximum resolution up to 1024x600)

1.2 Mechanical Specifications

Item	Standard Value	Unit
Outline Dimension	131.0(W) x 90.5(L) x 14.0(H) MAX	mm
Active Area	108.0(W) x 64.8(L)	mm

1.3 Absolute Maximum Ratings

Ta = 25°C

Item	Symbol	Condition	Min.	Max.	Unit
Power Supply	VIN	—	-0.3	6.0	V
Operating Temperature	T _{OP}	—	-20	70	°C
Storage Temperature	T _{ST}	—	-30	80	°C
Humidity	HD	Ta=60 °C	10	90	%RH

1.4 DC Electrical Characteristics

Ta = 25°C

Item	Symbol	Condition	Min.	Typ.	Max.	Unit
Power Supply Voltage	VIN	-	4.8	5.0	5.5	V
Power Supply Voltage of RTC	VBAT	-	2.0	-	3.6	V
Power Supply Current *1	IIN	VIN = 5.0V	-	670	-	mA
Power Consumption of System	PIN	VIN = 5.0V	-	3.35	-	W
IO High-Level input voltage	V _{IH}	-	2.0	-	V _{3V3} +0.3	V
IO Low-Level input voltage	V _{IL}	-	-	-	0.8	V
IO High-Level output voltage	V _{OH}	-	2.4	-	-	V
IO Low-Level output voltage	V _{OL}	-	-	-	0.4	V

1.5 Optical Characteristics

TFT LCD Module

VDD= 3.3 V, Ta=25°C

Item		Symbol	Condition	Min.	Typ.	Max.	unit	-	
Response time	Tr+Tf	25°C	-	-	37	56	ms	-	
Viewing angle	Top	$\theta Y+$	CR \geq 10		80	-	Deg.	Note 4	
	Bottom	$\theta Y-$			80	-			
	Left	$\theta X-$			80	-			
	Right	$\theta X+$			80	-			
Contrast ratio		CR		650	800	-	-	Note 3	
Color of CIE Coordinate (With B/L & T/P)	White	X	Ta = 25°C $\theta X, \theta Y = 0^\circ$		-	0.29	-	-	Note1
		Y			-	0.33	-		
	Red	X			-	0.55	-		
		Y			-	0.33	-		
	Green	X			-	0.34	-		
		Y			-	0.60	-		
	Blue	X			-	0.14	-		
		Y			-	0.09	-		
Average Brightness Pattern=white display (With T/P)*1		IV	VCC=12V PWM="High" (Duty=100%)	680	850	-	cd/m2	Note1	
Uniformity (With T/P)*2		ΔB		70	-	-	%	Note1	

Note 1:

*1 : $\Delta B = B(\min) / B(\max) * 100\%$

*2 : Measurement Condition for Optical Characteristics:

a : Environment: $25^{\circ}\text{C} \pm 5^{\circ}\text{C}$ / $60 \pm 20\%$ R.H , no wind , dark room below 10 Lux at typical lamp current and typical operating frequency.

b : Measurement Distance: 500 ± 50 mm , ($\theta = 0^{\circ}$)

c : Equipment: TOPCON BM-7 fast , (field 1°) , after 10 minutes operation.

d : The uncertainty of the C.I.E coordinate measurement ± 0.01 , Average Brightness $\pm 4\%$

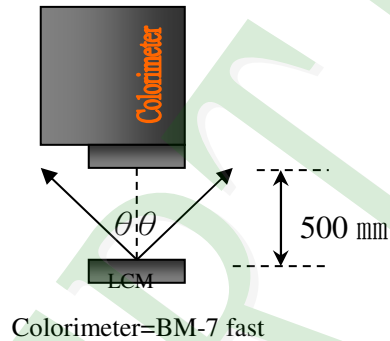
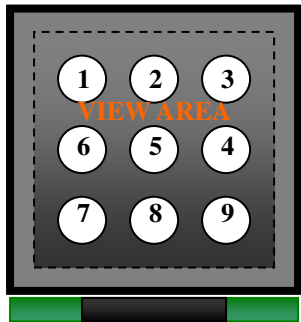

To be measured at the center area of panel with a viewing cone of 1° by Topcon luminance meter BM-7, after 10 minutes operation (module)

Note2: Definition of response time:

The output signals of photo detector are measured when the input signals are changed from "black" to "white"(falling time) and from "white" to "black"(rising time), respectively. The response time is defined as the time interval between the 10% and 90% of Amplitudes.

Refer to figure as below:

Normally White



Normally Black

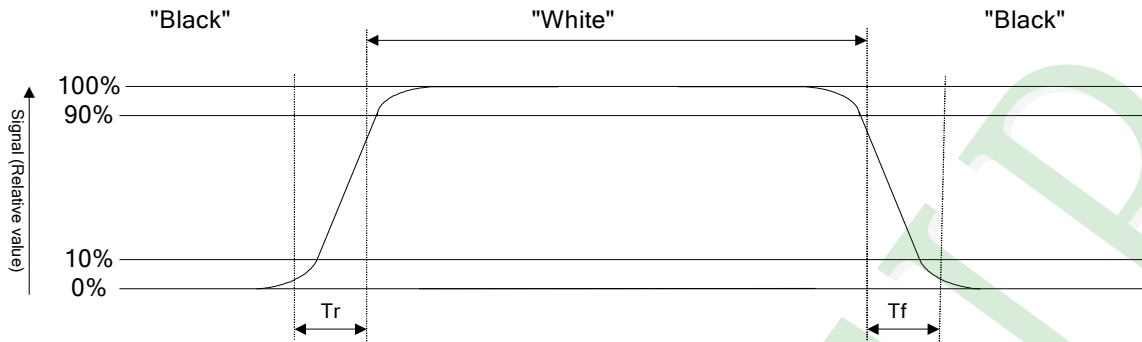

Note3: Definition of contrast ratio:

Contrast ratio is calculated with the following formula

$$\text{Contrast ratio (CR)} = \frac{\text{Photo detector output when LCD is at "White" state}}{\text{Photo detector output when LCD is at "Black" state}}$$

Note4: Definition of viewing angle:

Refer to figure as below:

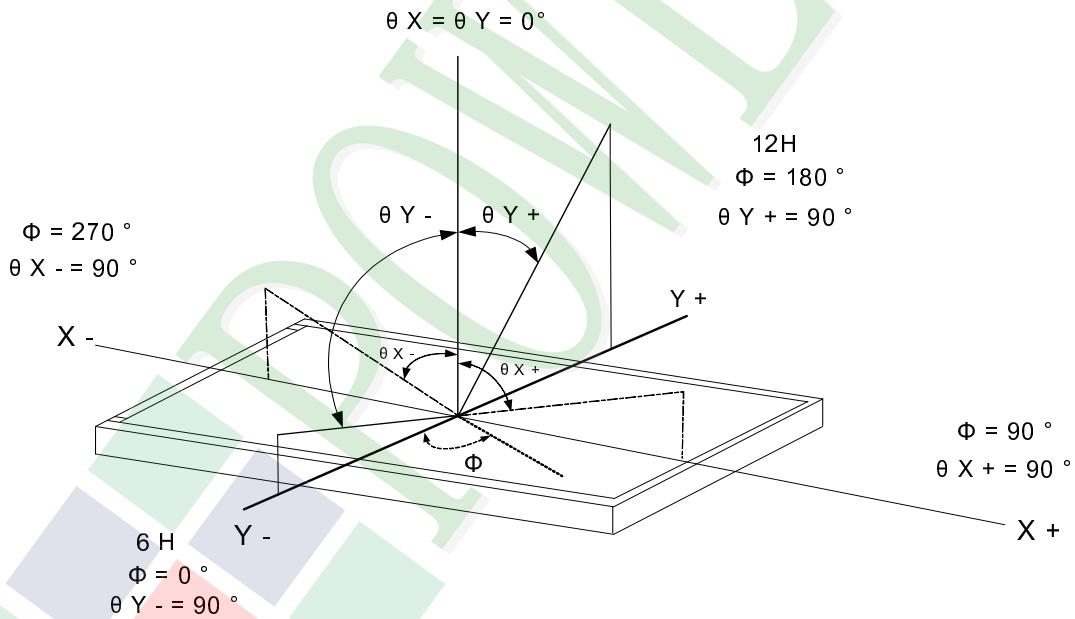

2. MODULE STRUCTURE

2.1 Counter Drawing

2.1.1 Mechanical Diagram

* See Appendix

2.1.2 Block Diagram

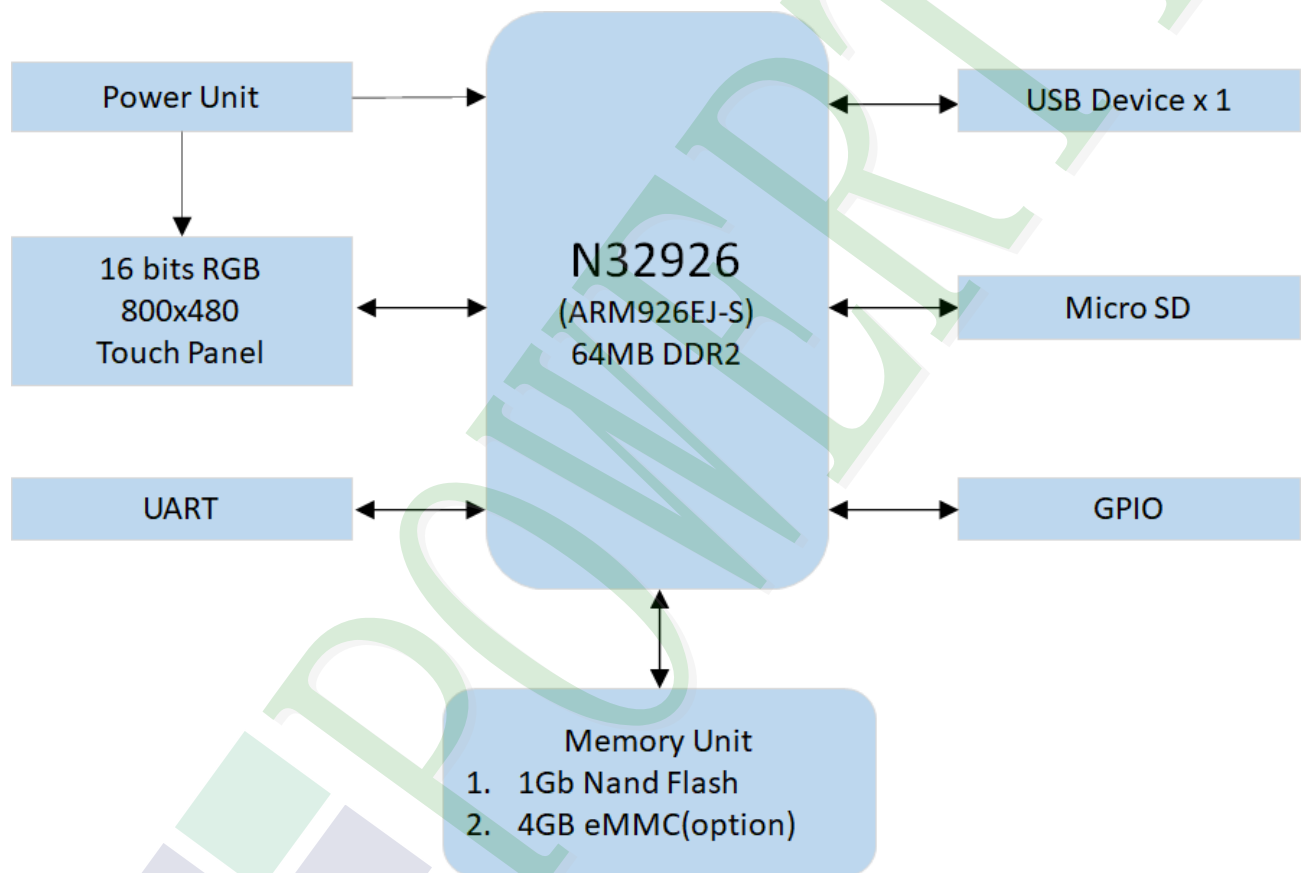

2.2 Interface Pin Description

J8 --- I/O

Pin No.	Symbol	Type	DESCRIPTION
1	GND	P	Power ground.
2	GPG9	IO	General Purpose I/O, Port G[9].
3	GPG8	IO	General Purpose I/O, Port G[8].
4	NC	-	Not Used.
5	GND	P	Power ground.
6	NC	-	Not Used.
7	GND	P	Power ground.
8	NC	-	Not Used.
9	GND	P	Power ground.
10	GPG2	IO	General Purpose I/O, Port G[2].
11	GND	P	Power ground.
12	GPG4	IO	General Purpose I/O, Port G[4].
13	GPG5	IO	General Purpose I/O, Port G[5].
14	GND	P	Power ground.
15	GPG3	IO	General Purpose I/O, Port G[3].
16	GND	P	Power ground.
17	HPOUT_L	A	Connect to N32926 pin 102.
18	HPOUT_R	A	Connect to N32926 pin 101.
19	GPG7	IO	General Purpose I/O, Port G[7].
20	GPA11	IO	General Purpose I/O, Port A[11].
21	GND	P	Power ground.
22	RESETn	I	System reset signal input, active low.
23	UART_RXD	I	UART port, receiver signal.

Pin No.	Symbol	Type	Function
24	UART_TXD	O	UART port, transmitter signal.
25	GND	P	Power ground.
26	VIN	P	DC 5.0V Power Supply.
27	VIN	P	DC 5.0V Power Supply.
28	NC	-	Not Used.
29	NC	-	Not Used.
30	GND	P	Power ground.

J9 --- USB 2.0 Device Micro USB type

Pin No.	Symbol	Type	DESCRIPTION
1	VUSB5V	P	USB +5.0V.
2	D-	DS	Data – (Data M).
3	D+	DS	Data + (Data P).
4	NC	-	Not Used.
5	GND	P	Ground.

J11 --- RTC POWER

Pin No.	Symbol	Type	Function
1	VBAT	P	Power Supply for RTC.
2	GND	P	Ground.

3. QUALITY ASSURANCE SYSTEM

3.1 Quality Assurance Flow Chart

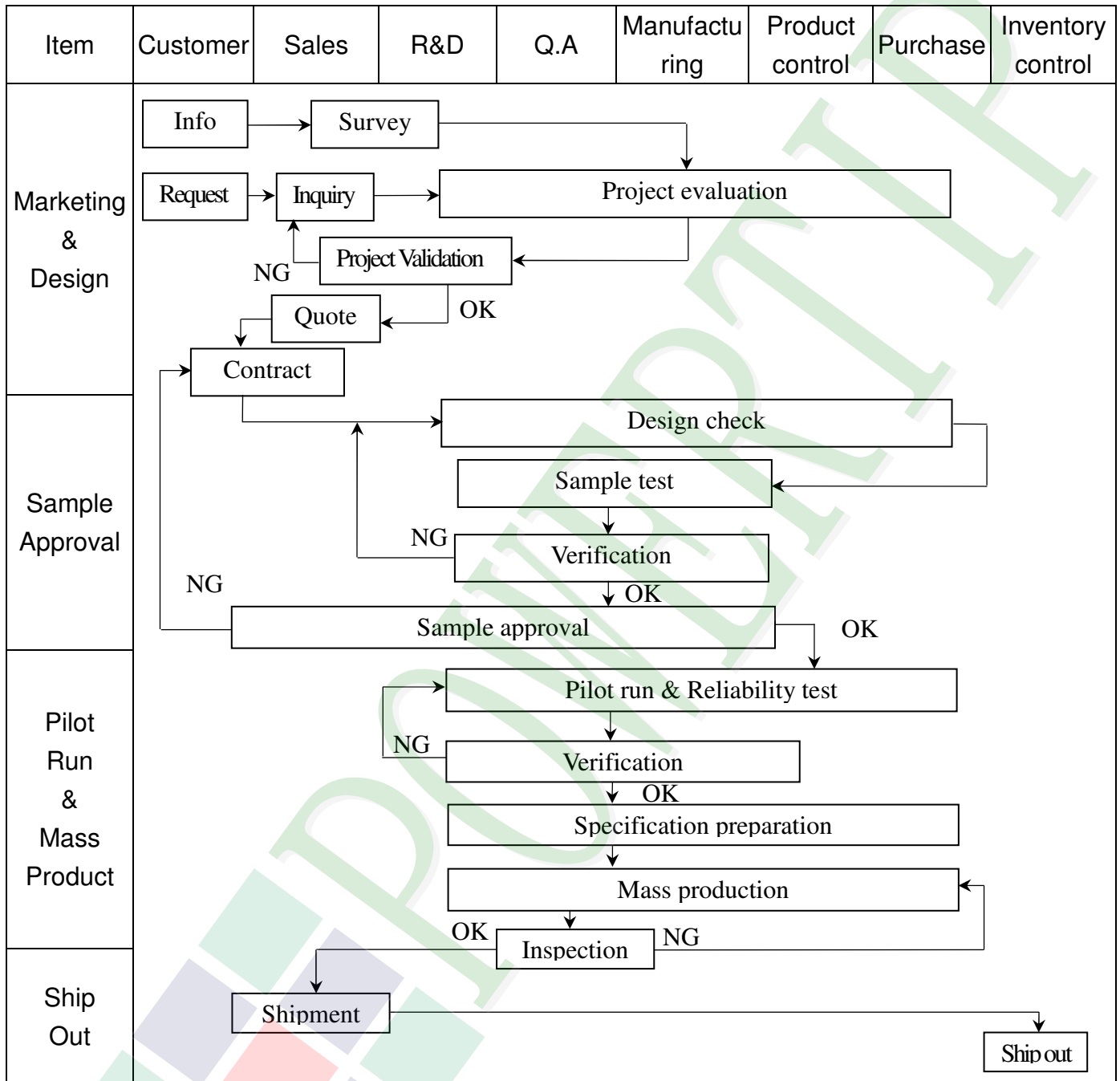

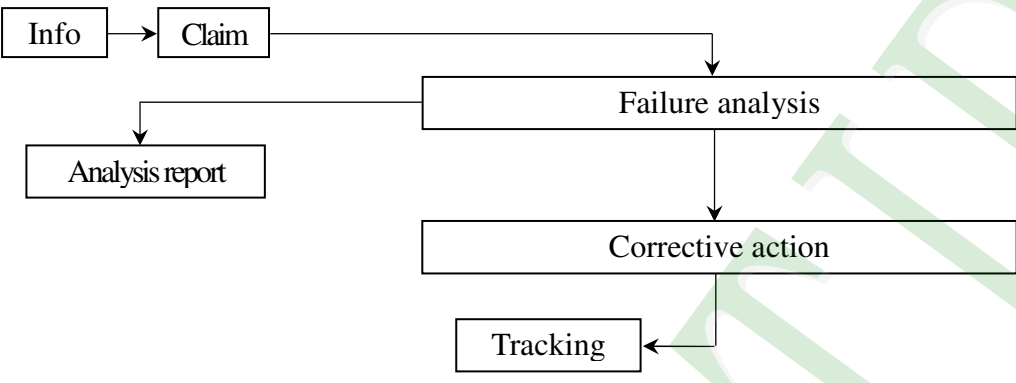
Item	Customer	Sales	R&D	Q.A	Manufacturing	Product control	Purchase	Inventory control
Sales Service	 <pre> graph TD Info[Info] --> Claim[Claim] Claim --> Failure[Failure analysis] Failure --> Report[Analysis report] Failure --> Action[Corrective action] Action --> Tracking[Tracking] </pre>							
Q.A Activity	1. ISO 9001 Maintenance Activities 3. Equipment calibration 5. Standardization Management				2. Process improvement proposal 4. Education And Training Activities			

5. PRECAUTION RELATING PRODUCT HANDLING

5.1 SAFETY

- 5.1.1 If the LCD panel breaks, be careful not to get the liquid crystal to touch your skin.
- 5.1.2 If the liquid crystal touches your skin or clothes, please wash it off immediately by using soap and water.

5.2 HANDLING

- 5.2.1 Avoid any strong mechanical shock which can break the glass.
- 5.2.2 Avoid static electricity which can damage the CMOS LSI—When working with the module, be sure to ground your body and any electrical equipment you may be using.
- 5.2.3 Do not remove the panel or frame from the module.
- 5.2.4 The polarizing plate of the display is very fragile. So, please handle it very carefully, do not touch, push or rub the exposed polarizing with anything harder than an HB pencil lead (glass, tweezers, etc.)
- 5.2.5 Do not wipe the polarizing plate with a dry cloth, as it may easily scratch the surface of plate.
- 5.2.6 Do not touch the display area with bare hands, this will stain the display area.
- 5.2.7 Do not use ketonic solvent & aromatic solvent. Use with a soft cloth soaked with a cleaning naphtha solvent.
- 5.2.8 To control temperature and time of soldering is $320 \pm 10^{\circ}\text{C}$ and 3 ~ 5 sec.
- 5.2.9 To avoid liquid (include organic solvent) stained on LCM.
- 5.2.10 Caution! (LCM products with Capacitive Touch Panel)
Strong EMI-sources such as switch-mode power supplies (SPS) can lead to touch malfunction (e.g., ghost-touches). Therefore, the touch needs to be thoroughly tested inside the target application.
- 5.2.11 CAUTION: Continuously displaying same static image will result in high possibility of image sticking/image burn-in effect due to TFT panel characteristic.
- 5.2.12 Double-sided tape designed to be attached with the customer's mechanical device, please follow up the rules and regulations published by the original manufacturer of double-side tape for the attachment operation.

5.3 STORAGE

- 5.3.1 Store the panel or module in a dark place where the temperature is $25^{\circ}\text{C} \pm 5^{\circ}\text{C}$ and the humidity is below 65% RH.
- 5.3.2 Do not place the module near organics solvents or corrosive gases.
- 5.3.3 Do not crush, shake, or jolt the module.

5.4 TERMS OF WARRANTY

- 5.4.1 Applicable warrant period
The period is within thirteen months since the date of shipping out under normal using and storage conditions.
- 5.4.2 Unaccepted responsibility
This product has been manufactured to your company's specification as a part for use in your company's general electronic products. It is guaranteed to perform according to delivery specifications. For any other use apart from general electronic equipment, we cannot take responsibility if the product is used in nuclear power control equipment, aerospace equipment, fire and security systems or any other applications in which there is a direct risk to human life and where extremely high levels of reliability are required.

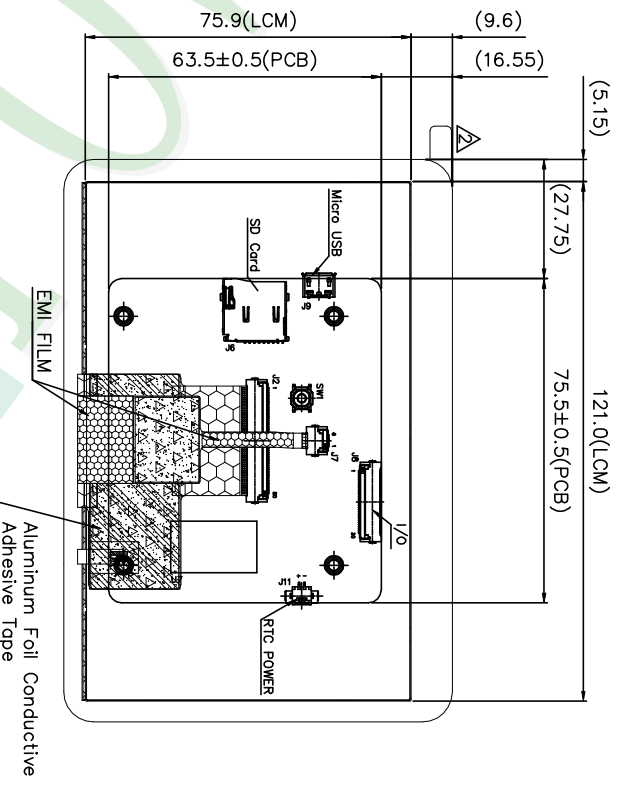
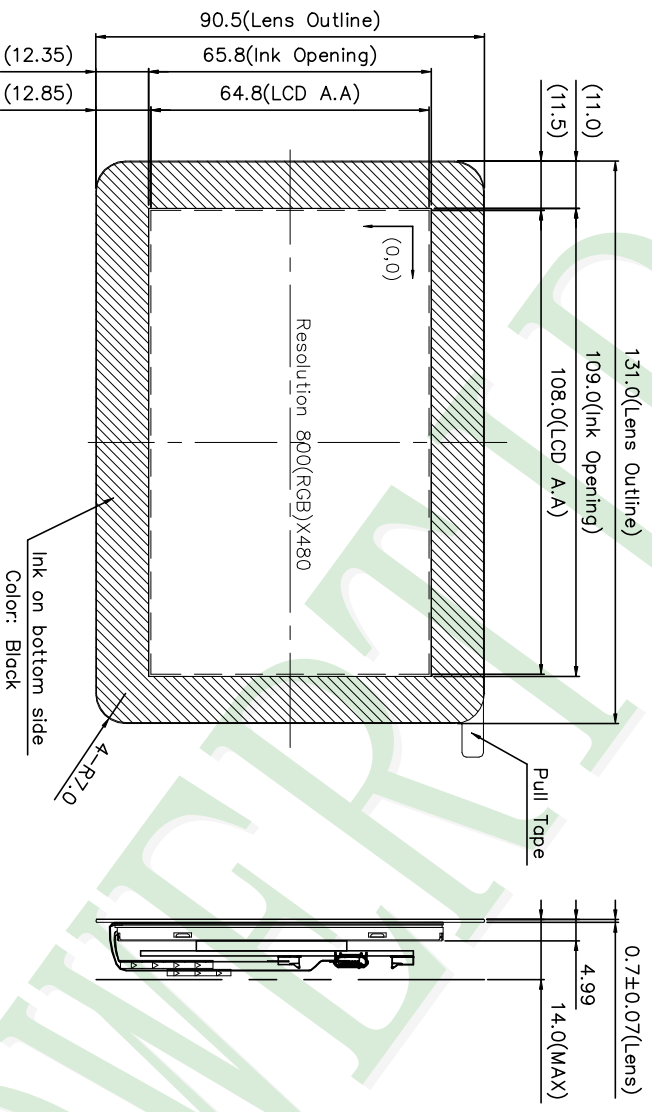

- NOTES:
- 1.LCD TYPE: TFT LCD
 - 2.LCD DISPLAY: Normally Black/TRANSMISSIVE
 - 3.VIEW DIRECTION: Full Viewing Angle
 - 4.J8: OMRON XF2M-3015-1A or Compatible
 - 5.J11: Molex 532610271 or Compatible
 6. The tolerance unless classified $\pm 0.3\text{mm}$

007			
006			
005			
004			
003			
002	Modify DRAWING	Bright	2021/12/15
001	NEW DRAWING	Bright	2021/04/01
REV	REV BY	REVISER	DATE

PART NO:	HNA800480T030-ZHC
DRAWING NAME:	LMD-HNA800480T030-ZHC
TITLE:	LCD MODULE DRAWING

Design		Bright Chiang	
Check	Check	Maros Lu	
Approve	Approve	Daniel Lin	

久正光電股份有限公司
POWER TIP TECHNOLOGY CORPORATION

Unit	MM	Surface	
Scale	FIT	Material	
Page	1/1	Thickness	
Quantity			

Resolution	Level
1 ~ 4	-
4 ~ 16	-
16 ~ 63	-
63 ~ 250	-
250 ~ 1000	-

LCM包裝規格書

LCM Packaging Specifications

Documents NO. PKG-HNA800480T030-ZHC

Approve	Check	Contact
Marcs	Nini	Bright

1. 包裝材料規格表 (Packaging Material) : (per carton)

No.	Item	Model	Dimensions (mm)	1Pcs Weight	Quantity	Total Weight
1	成品 (Product)	HNA800480T030-ZHC	131 X 90.5	0.113	12	1.356
2	紙內襯 (1)Lined with paper	BX00000000132	347 X 262	0.07	12	0.84
3	抗靜電袋(2)Antistatic Bag	BAG240170ARABA	170 X 240	0.005	12	0.06
4	內盒(3)Product Box	BX00000000131	258 X 175 X 58	0.11	12	1.32
5	內盒(4)Product Box	BX36627063ABBA	383 X 270 X 66	0.2	6	1.2
6	保利龍板(5)Polylon board	OTPLB00PL08ABA	550 X 393 X 20	0.0284	2	0.0568
7	外紙箱(6)Carton	BX57041027CCBA	570 X 410 X 265	1.4208	1	1.4208
8						
9						
10						
11						
12						

2. 一整箱總重量 (Total LCD Weight in carton) : 6.25 Kg±10%

3. 單箱數量規格表 (Packaging Specifications and Quantity) :

(1) LCM quantity per small box : no per lined with paper	1	x no of small box	1	=	1
(2) Total LCM quantity in big box : quantity per small box	1	x no of big boxes	2	=	2
(3) Total LCM quantity in carton : quantity per big box	2	x no of cartons	6	=	12

(1) 紙內襯

Lined with paper

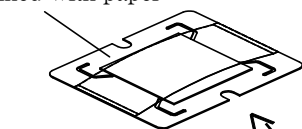

成品
Product



(2) 抗靜電袋
Antistatic Bag

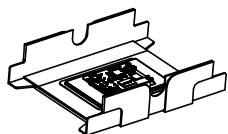

(3) 內盒
Product Box

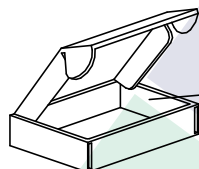

(3) 內盒
Product Box

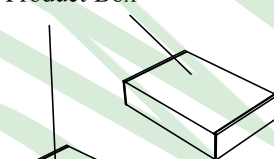

(4) 內盒
Product Box

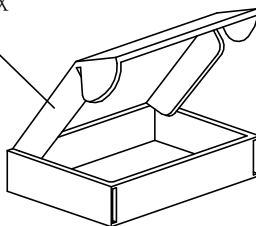

(5) 保利龍板
Polylon board

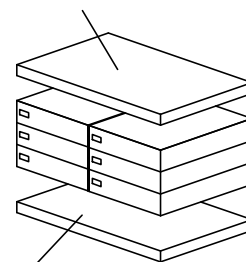

(5) 保利龍板
Polylon board



(6) 外紙箱
Carton

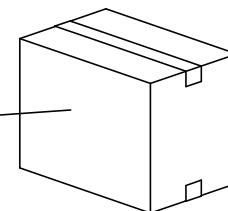

特 記 事 項 (REMARK)