

STRAIGHT PLUG FEMALE

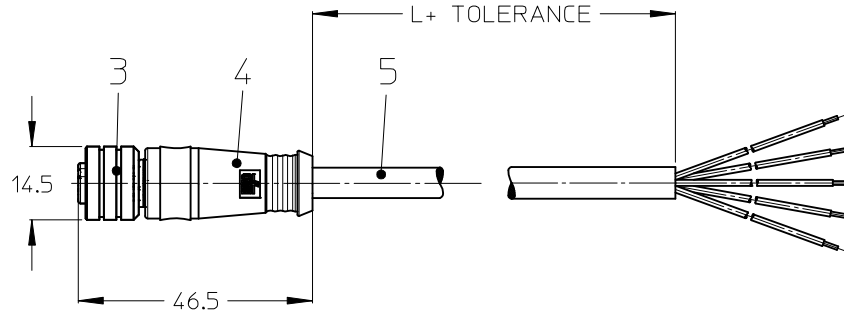
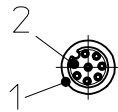

NOTES:

TEMPERATURE RANGE SEE TABLE ON PAGE 2

CONTACT CURRENT RATING 3-5 POLES 4A
8 POLES 2A

VOLTAGE RATING 3-4 POLES 250V
5 POLES 60V
8 POLES 30V

PROTECTION CLASS IP 67

CABLE TOLERANCES

≤ 1m +20/-10mm
1m - 5m ± 25mm
5m - 10m ± 30mm
> 10m ± 30mm
> 20m ± 50mm

3 WIRE	4 WIRE	5 WIRE	8 WIRE
PIN # WIRE	PIN # WIRE	PIN # WIRE	PIN # WIRE
1 BROWN 2 - 3 BLUE 4 BLACK 5 -	1 BROWN 2 WHITE 3 BLUE 4 BLACK 5 -	1 BROWN 2 WHITE 3 BLUE 4 BLACK 5 GREY	1 WHITE 2 BROWN 3 GREEN 4 YELLOW 5 GREY 6 PINK 7 BLUE 8 RED
REQUIRED TO IEC 60947-5-2			REQUIRED TO DIN 47100

5	CABLE	SEE TABLE (PAGE 2)	---
4	OVERMOULDING	TPU	BLACK
3	MALE COUPLING NUT	BRASS	NI PLATED
2	PIN CONTACT	BRASS	GOLD PLATED
1	INSERT	PA	BLACK
ITEM	PART	MATERIAL	FINISH

ENTER DESCRIPTION EC NO: IPG2015-1151 DRWN:ZISMAYILOV 2014/12/17 CHKD:JULETENNER2014/12/18 APPR:CBURGER 2014/12/18 REV	QUALITY SYMBOLS ▽=0 ◻=0	GENERAL TOLERANCES (UNLESS SPECIFIED) mm INCH 4 PLACES ± --- ± --- 3 PLACES ± --- ± --- 2 PLACES ± 0.05 ± --- 1 PLACE ± 0.10 ± --- 0 PLACE ± --- ± --- ANGULAR ± .5 ° DRAFT WHERE APPLICABLE MUST REMAIN WITHIN DIMENSIONS	DIMENSION STYLE MM ONLY DRAWN BY DATE PMERUNKA 2012/04/23 CHECKED BY DATE APOHL 2013/11/15 APPROVED BY DATE APOHL 2013/11/18	SCALE 1:1 DESIGN UNITS METRIC THIRD ANGLE PROJECTION	TITLE CSE M12 XP AC FE STR XM SE UNSH molex MATERIAL NO. SEE TABLE DOCUMENT NO. SD-120065-050 SHEET NO. 1 OF 4
	THIS DRAWING CONTAINS INFORMATION THAT IS PROPRIETARY TO MOLEX INCORPORATED AND SHOULD NOT BE USED WITHOUT WRITTEN PERMISSION				
	SIZE A3				
	SEE TABLE				

NUMERICAL CODE (Available parts see table page 3 ff others on request.)



80 = M12x1
single ended

poles:
3 = 3 poles
4 = 4 poles
5 = 5 poles
8 = 8 poles

header:
000 = plug female straight

Cable:
E02 = 0,25mm², PVC black
E03 = 0,34mm², PVC black
H08 = 0,25mm², PUR black LSOH
H09 = 0,34mm², PUR black LSOH
P02 = 0,25mm², PUR/PVC black
P03 = 0,34mm², PUR/PVC black
P82 = 0,34mm², PUR black irradiated
P12 = 0,50mm², PVC black
P04 = 0,50mm², PVC black





M = meter
C = centimeter

length:
Example
020 = 2 m





CABLE TYPE	WIRE GAUGE	CABLE JACKET	UL	CSA	static	flexing	drag chain tested	other
E02	0.25mm ²	PVC black	STYLE 2464	I/II A/B 80°/300V	-30°C to +80°C 5xD	-5°C to +80°C 9xD	---	---
E03	0.34mm ²	PVC black	STYLE 2464	I/II A/B 80°/300V	-30°C to +80°C 5xD	-5°C to +80°C 9xD	---	---
H08	0.25mm ²	PUR black LSOH	AWM STYLE 21198/10493	APPROVED	-50°C to +80°C 5xD	-25°C to +80°C 10xD	2000000 cycles	---
H09	0.34mm ²	PUR black LSOH	AWM STYLE 21198/10493	APPROVED	-50°C to +80°C 5xD	-25°C to +80°C 10xD	drag chain 60°C	---
I03	0.34mm ²	PVC grey	---	---	-30°C to +70°C	-5°C to +70°C	---	---
K05	0.34mm ²	TPE yellow	ITC E195601 or PLTC	AWM I/II A/B FT4 LL54185	---	---	---	CSA-US: ITC LL54185-02
P02	0.25mm ²	PUR/PVC black	not applicable	not applicable	-30°C to +80°C 7xD	-5°C to +80°C 15xD	---	---
P03	0.34mm ²	PUR/PVC black	not applicable	not applicable	-30°C to +80°C 7xD	-5°C to +80°C 15xD	---	---
P82	0.34mm ²	irrad. PUR orange	---	---	-50°C to +105°C 5xD	-40°C to +105°C 7.5xD	---	---
I20	0.34mm ²	PVC grey	---	---	-30°C to +70°C	-5°C to +70°C	---	---
I04	0.50mm ²	PVC grey	---	---	-30°C to +70°C	-5°C to +70°C	---	---
P12	0.50mm ²	PVC black	---	---	-30°C to +90°C	-5°C to +90°C	---	---
I26	0.34mm ²	PVC grey	not applicable	not applicable	-30°C to +70°C	-5°C to +70°C	---	---
P04	0.50mm ²	PVC black	---	---	-30°C to +90°C	-5°C to +90°C	---	---

ENTER DESCRIPTION EC NO: IPG2015-1151 DRWINZI SMAYILOV 2014/12/17 CHYKOJULETENNER 2014/12/18 APPR: CBURGER 2014/12/18 REV DESCRIPTION	QUALITY SYMBOLS	GENERAL TOLERANCES (UNLESS SPECIFIED) mm INCH 4 PLACES ± --- ± --- 3 PLACES ± --- ± --- 2 PLACES ± 0.05 ± --- 1 PLACE ± 0.10 ± --- 0 PLACE ± --- ± --- ANGULAR ± .5 ° DRAFT WHERE APPLICABLE MUST REMAIN WITHIN DIMENSIONS	DIMENSION STYLE MM ONLY DRAWN BY DATE PMERUNKA 2012/04/23 CHECKED BY DATE APOHL 2013/11/15 APPROVED BY DATE APOHL 2013/11/18	SCALE 1:1 DESIGN UNITS METRIC THIRD ANGLE PROJECTION	TITLE CSE M12 XP AC FE STR XM SE UNSH	
	▼=0 ▽=0					MATERIAL NO. SEE TABLE
	THIS DRAWING CONTAINS INFORMATION THAT IS PROPRIETARY TO MOLEX INCORPORATED AND SHOULD NOT BE USED WITHOUT WRITTEN PERMISSION					

PART NUMBER	NUMERICAL CODE	CABLE LENGTH "L" IN M	PART NUMBER	NUMERICAL CODE	CABLE LENGTH "L" IN M	PART NUMBER	NUMERICAL CODE	CABLE LENGTH "L" IN M
1200060107	803000E03M003	0.3M	1200063224	804000E03M003	0.3M	1200064435	804000H09M100G	10M
1200060027	803000E03M006	0.6M	1200060032	804000E03M005	0.5M	12000658009	804000H09M100H	10M
12000658562	803000E03M010	1M	1200060426	804000E03M010	1M	12000658191	804000H09M150	1.5M
1200060001	803000E03M020	2M	1200060014	804000E03M020	2M	12000658218	804000H09M150G	1.5M
12000658219	803000E03M0201	2.01M	1200060427	804000E03M0201	2.01M	12000658880	804000H09M200	2M
12000658887	803000E03M020H	2M	1200061337	804000E03M0205	2.05M	1200065006	804000H09M250G	2.5M
1200061958	803000E03M021	2.1M	12000658894	804000E03M020G	2M	12000658609	804000P02M020	2M
1200060113	803000E03M030	3M	1200062866	804000E03M020H	2M	12000658927	804000P02M050	5M
12000658563	803000E03M040	4M	1200060428	804000E03M030	3M	1200063402	804000P03M003	0.3M
1200060002	803000E03M050	5M	1200063443	804000E03M030H	3M	1200010061	804000P03M003W	0.3M
1200060115	803000E03M0501	5.01M	12000658570	804000E03M040	4M	12000658321	804000P03M005	0.5M
1200060116	803000E03M0505	5.05M	1200060015	804000E03M050	5M	1200063940	804000P03M0051	0.51M
12000658889	803000E03M050H	5M	1200060429	804000E03M0501	5.01M	1200063121	804000P03M0053	0.53M
1200062071	803000E03M060	6M	1200060430	804000E03M0505	5.05M	1200010062	804000P03M005W	0.5M
1200060003	803000E03M100	10M	12000658288	804000E03M050G	5M	1200061785	804000P03M006	0.6M
12000658350	803000E03M1001	10.01M	1200062130	804000E03M050H	5M	1200063227	804000P03M0063	0.63M
1200060117	803000E03M1005	10.05M	12000658782	804000E03M060	6M	1200010063	804000P03M006W	0.6M
1200060119	803000E03M150	10.5M	12000658896	804000E03M075	7.5M	12000658064	804000P03M010	1M
1200060121	803000E03M200	20M	1200060016	804000E03M100	10M	12000658622	804000P03M010G	1M
1200060124	803000E03M2505	25.05M	1200063407	804000E03M1001	10.01M	1200010064	804000P03M010W	1M
12000659584	803000H09M003	0.3M	12000658270	804000E03M1005	10.05M	12000658545	804000P03M015	1.5M
12000658636	803000H09M010	1M	12000658882	804000E03M100H	10M	1200010065	804000P03M015W	1.5M
12000658637	803000H09M015	1.5M	1200064422	804000E03M120	10.2M	1200060018	804000P03M020	2M
12000658175	803000H09M020	2M	1200060431	804000E03M150	10.5M	1200060456	804000P03M0201	2.01M
12000658638	803000H09M030	3M	12000658475	804000E03M1501	10.51M	1200010066	804000P03M020W	2M
12000658639	803000H09M040	4M	1200062264	804000E03M1505	10.55M	1200010776	804000P03M020X	2M
12000658176	803000H09M050	5M	1200060432	804000E03M200	20M	1200060034	804000P03M025	2.5M
12000658177	803000H09M100	10M	1200063647	804000E03M2001	20.01M	1200060457	804000P03M030	3M
1200061765	803000P03M002	0.2M	1200062992	804000E03M200H	20M	12000658623	804000P03M030G	3M
1200062098	803000P03M006	0.6M	1200061528	804000E03M250	20.5M	1200010067	804000P03M030W	3M
1200060152	803000P03M010	1M	1200061913	804000E03M300	30M	12000652143	804000P03M040	4M
1200060004	803000P03M020	2M	12000658228	804000E03M3001	30.01M	12000658630	804000P03M040G	4M
1200060153	803000P03M030	3M	12000658891	804000H09M003	0.3M	1200060019	804000P03M050	5M
1200065012	803000P03M030G	3M	12000658640	804000H09M010	1M	1200060458	804000P03M0501	5.01M
1200064093	803000P03M032	3.2M	12000658550	804000H09M015	1.5M	12000651780	804000P03M050G	5M
12000658610	803000P03M040	4M	12000658178	804000H09M020	2M	1200062347	804000P03M050H	5M
1200060005	803000P03M050	5M	12000658907	804000H09M020H	2M	1200010068	804000P03M050W	5M
12000651769	803000P03M050G	5M	12000658473	804000H09M030	3M	12000652144	804000P03M060	6M
1200063415	803000P03M0707	7.07M	12000658641	804000H09M040	4M	12000651782	804000P03M100	10M
1200060006	803000P03M100	10M	12000658179	804000H09M050	5M	1200064390	804000P03M1001	10.01M
1200063673	803000P03M1001	10.01M	1200064434	804000H09M050G	5M	12000658492	804000P03M100G	10M
1200062811	803000P03M100H	10M	12000658008	804000H09M050H	5M	1200062167	804000P03M100H	10M
1200060157	803000P03M150	10.5M	12000658190	804000H09M100	10M	1200010069	804000P03M100W	10M
1200060158	803000P03M200	20M						
1200062772	803000P03M250	20.5M						
1200062754	803000P82M004	0.4M						
1200062454	803000P82M0067	0.67M						
1200064073	803000P82M010	1M						
1200064256	803000P82M020	2M						
1200061240	803000P82M050	5M						
12000659040	804000E02M050	5M						
12000659038	804000E02M100	10M						
12000658266	804000E03C550	50.5M						
12000658983	804000E03M002	0.2M						

ENTER DESCRIPTION EC NO: IPG2015-1151 DRINKWZI SWAYILOV 2014/12/17 CHYKDJULETENNER2014/12/18 APPR:CBURGER 2014/12/18	QUALITY SYMBOLS  = 0  = 0	GENERAL TOLERANCES (UNLESS SPECIFIED)		DIMENSION STYLE MM ONLY		SCALE 1:1	DESIGN UNITS METRIC		 THIRD ANGLE PROJECTION		
		4 PLACES ± --- ± --- 3 PLACES ± --- ± --- 2 PLACES ± 0.05 ± --- 1 PLACE ± 0.10 ± --- 0 PLACE ± --- ± ---		DRAWN BY: PMERUNKA DATE: 2012/04/23		CHECKED BY: APOHL DATE: 2013/11/15		TITLE: CSE M12 XP AC FE STR XM SE UNSH			
		APPROVED BY: APOHL DATE: 2013/11/18		MATERIAL NO.		DOCUMENT NO.					
		ANGULAR ± .5 ° DRAFT WHERE APPLICABLE MUST REMAIN WITHIN DIMENSIONS		SEE TABLE		SD-120065-050		SHEET NO. 3 OF 4			

PART NUMBER	NUMERICAL CODE	CABLE LENGTH "L" IN M	PART NUMBER	NUMERICAL CODE	CABLE LENGTH "L" IN M	PART NUMBER	NUMERICAL CODE	CABLE LENGTH "L" IN M
1200064033	804000P03M120	10.2M	1200061431	805000P03M150	10.5M	1200651795	808000P02M070	7M
1200062853	804000P03M150	10.5M	1200064292	805000P03M200	20M	1200650955	808000P02M080	8M
1200010070	804000P03M150W	10.5M	1200064313	805000P03M200G	20M	1200650956	808000P02M0801	8.01M
1200060461	804000P03M200	20M	1200063041	805000P12M0033	0.33M	1200650957	808000P02M100	10M
1200658806	804000P04M003	0.3M	1200658086	805000P12M020	2M	1200658021	808000P02M150	10.5M
1200063017	804000P04M0083	0.83M	1200064445	805000P12M023	2.3M	1200651817	808000P02M200	20M
1200063114	804000P04M0163	1.63M	1200062858	805000P12M100	10M	1200651818	808000P02M250	20.5M
1200658807	804000P04M020	2M	1200065005	805000P82M020	2M	1200651820	808000P02M300	30M
1200062364	804000P04M020G	2M	1200060715	805000P82M050	5M	1200658103	808000P19M005	0.5M
1200064072	804000P82M006	0.6M	1200658966	805000P82M0507	5.07M	1200062765	808000P19M020	2M
1200655336	804000P82M0107	1.07M	1200658299	805000P82M100	10M	1200062675	808000P19M030	3M
1200064044	804000P82M020	2M	1200659026	805000P82M1007	10.07M	1200651796	808000P19M040	4M
1200062254	804000P82M0207	2.07M	1200658920	808000E02M005H	0.5M	1200062676	808000P19M050	5M
1200060466	804000P82M030	3M	1200658860	808000E02M00616	0.61M	1200655074	808000P19M060	6M
1200655605	804000P82M0307	3.07M	1200658511	808000E02M010	1M	1200652019	808000P19M100	10M
1200060035	804000P82M0507	5.07M	1200658921	808000E02M010H	1M	1200658104	808000P19M150	10.5M
1200060468	804000P82M100	10M	1200658277	808000E02M020	2M	1200655040	80C000H45M020	2M
1200060036	804000P82M1007	10.7M	1200658590	808000E02M030	3M	1200655041	80C000H45M040	4M
1200658902	804000P82M2007	20.7M	1200658591	808000E02M040	4M	1200655042	80C000H45M050	5M
1200658502	805000E03M005	0.5M	1200658224	808000E02M050	5M	1200655044	80C000H45M100	10M
1200658208	805000E03M0061	0.61M	1200658309	808000E02M0501	5.01M	1200659214	805000P03M300	30M
1200063314	805000E03M010	1M	1200658278	808000E02M100	10M	1200659224	805006P03M200	20M
1200060634	805000E03M020	2M	1200658551	808000E02M1001	10.01M	1200659225	805006P03M300	30M
1200658503	805000E03M0201	2.01M	1200658812	808000E02M150	10.5M	1200659230	805007P03M010	1M
1200658165	805000E03M030	3M	1200658984	808000E02M2501	20.51M	1200659231	805007P03M200	20M
1200658592	805000E03M040	4M	1200658642	808000H08M010	1M			
1200651978	805000E03M050	5M	1200658643	808000H08M015	1.5M			
1200658210	805000E03M0501	5.01M	1200658644	808000H08M020	2M			
1200658331	805000E03M050H	5M	1200658813	808000H08M025	2.5M			
1200060638	805000E03M100	10M	1200658645	808000H08M030	3M			
1200658928	805000E03M1001	10.01M	1200658646	808000H08M040	4M			
1200655081	805000E03M150	10.5M	1200658244	808000H08M050	5M			
1200658081	805000E03M200	20M	1200658264	808000H08M100	10M			
1200063779	805000E03M300	30M	1200658930	808000H08M150	10.5M			
1200658632	805000H09M010	1M	1200658899	808000H08M250	20.5M			
1200658633	805000H09M015	1.5M	1200658525	808000P02C350	30.5M			
1200658172	805000H09M020	2M	1200655073	808000P02M003	0.3M			
1200658634	805000H09M030	3M	1200651794	808000P02M010	1M			
1200658635	805000H09M040	4M	1200650951	808000P02M020	2M			
1200658173	805000H09M050	5M	1200658022	808000P02M030	3M			
1200658174	805000H09M100	10M	1200650952	808000P02M040	4M			
1200658780	805000H09M200	20M	1200650953	808000P02M050	5M			
1200060646	805000P03M003	0.3M	1200650954	808000P02M060	6M			
1200658197	805000P03M010	1M						
1200060647	805000P03M020	2M						
1200065004	805000P03M0201	2.01M						
1200062521	805000P03M030	3M						
1200658020	805000P03M040	4M						
1200651792	805000P03M050	5M						
1200658977	805000P03M050G	5M						
1200658990	805000P03M050H	5M						
1200652154	805000P03M060	6M						
1200060649	805000P03M100	10M						
1200658991	805000P03M100H	10M						

ENTER DESCRIPTION EC NO: IPG2015-1151 DRWINAZI SWAYILOV 2014/12/17 CHYKDJULETTENNER 2014/12/18 APPR: CBOURGER 2014/12/18	QUALITY SYMBOLS  = 0  = 0	GENERAL TOLERANCES (UNLESS SPECIFIED)		DIMENSION STYLE MM ONLY		SCALE 1:1	DESIGN UNITS METRIC	 THIRD ANGLE PROJECTION
		4 PLACES ± --- ± ---	DRAWN BY PMERUNKA	DATE 2012/04/23	TITLE CSE M12 XP AC FE STR XM SE UNSH			
		3 PLACES ± --- ± ---	CHECKED BY APOHL	DATE 2013/11/15				
		2 PLACES ± 0.05 ± ---	APPROVED BY APOHL	DATE 2013/11/18				
1 PLACE ± 0.10 ± ---	MATERIAL NO. SEE TABLE		DOCUMENT NO. SD-120065-050	SHEET NO. 4 OF 4				
0 PLACE ± --- ± ---	ANGULAR ± .5 °		THIS DRAWING CONTAINS INFORMATION THAT IS PROPRIETARY TO MOLEX INCORPORATED AND SHOULD NOT BE USED WITHOUT WRITTEN PERMISSION					
DRAFT WHERE APPLICABLE MUST REMAIN WITHIN DIMENSIONS								