

PACKAGE DIMENSIONS

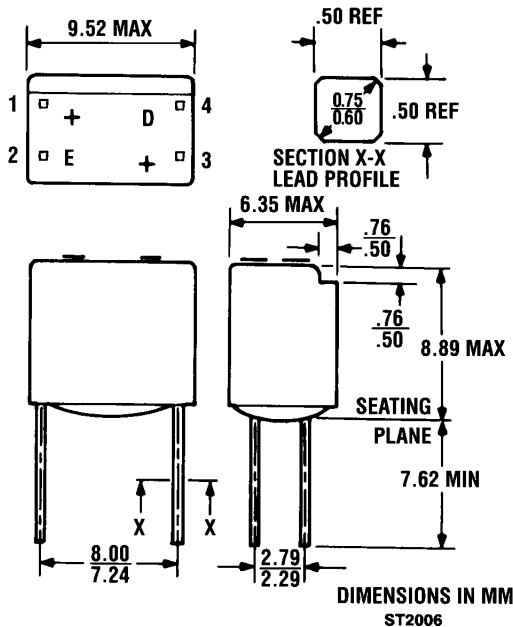

DESCRIPTION

The H24A series consists of a gallium arsenide infrared emitting diode coupled with a silicon phototransistor. The devices are housed in a low-cost plastic package with lead spacing compatible with a dual in-line package.

FEATURES

- 4-pin configuration
- Small package size and low cost
- UL recognized-file E51868

APPLICATIONS

- Digital logic inputs
- Microprocessor inputs
- Industrial controls

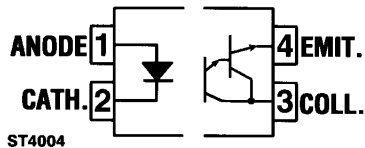

Equivalent Circuit

ABSOLUTE MAXIMUM RATINGS

TOTAL PACKAGE

Storage temperature -55°C to 85°C
 Operating temperature -55°C to 85°C
 Lead solder temperature 260°C for 5 sec

INPUT DIODE

Power dissipation (25°C ambient) 100 mW
 Derate linearly (above 25°C) 1.67 mW/°C
 Continuous forward current 60 mA
 Reverse voltage 4 V

DETECTOR

Power dissipation (25°C ambient) 150 mW
 Derate linearly (above 25°C) 2.5 mW/°C
 V_{CEO} 30 V
 V_{ECO} 6 V
 Continuous forward current 100 mA

ELECTRICAL CHARACTERISTICS (25°C Temperature Unless Otherwise Specified)

INDIVIDUAL COMPONENT CHARACTERISTICS						
CHARACTERISTIC	SYMBOL	MIN.	TYP.	MAX.	UNITS	TEST CONDITIONS
INPUT DIODE						
Forward voltage	V_F			1.7	V	$I_F=60\text{ mA}$
Reverse current	I_R			1	μA	$V_R=3\text{ V}$
Reverse breakdown voltage	$V_{BR(R)}$	4			V	$I_R=10\ \mu\text{A}$
Capacitance	C_i		30		pF	$V=0, f=1\text{ MHz}$
OUTPUT DETECTOR						
Breakdown voltage Collector to emitter	BV_{CEO}	30			V	$I_C=1\text{ mA}, I_F=0$
Breakdown voltage Emitter to Collector	BV_{ECO}	7			V	$I_C=100\ \mu\text{A}, I_F=0$
Collector dark current	I_{CEO}		5	100	nA	$V_{CE}=10\text{ V}, I_F=0$
Capacitance	C_{CE}		3.3		pF	$V_{CE}=5\text{ V}, f=1\text{ MHz}$

TRANSFER CHARACTERISTICS						
CHARACTERISTIC	SYMBOL	MIN.	TYP.	MAX.	UNITS	TEST CONDITIONS
DC CURRENT TRANSFER RATIO						
H24A1	I_C	10.0			mA	$I_F=10\text{ mA}, V_{CE}=10\text{ V}$
H24A2	I_C	2.0			mA	$I_F=10\text{ mA}, V_{CE}=10\text{ V}$
Saturation voltage	$V_{CE(SAT)}$		0.1	0.4	V	$I_F=10\text{ mA}, I_C=0.5\text{ mA}$
Turn-on time	t_{on}		9		μs	$I_C=2\text{ mA}, V_{CE}=10\text{ V}, R_L=100\ \Omega$
Turn-off time	t_{off}		4		μs	$I_F=2\text{ mA}, V_{CE}=10\text{ V}, R_L=100\ \Omega$
Turn-on time	t_{on}		6.5		μs	$I_F=10\text{ mA}, V_{CE}=5\text{ V}, R_L=10\text{K}\Omega$
Turn-off time	t_{off}		165		μs	$I_F=10\text{ mA}, V_{CE}=5\text{ V}, R_L=10\text{K}\Omega$

ISOLATION CHARACTERISTICS						
CHARACTERISTICS	SYMBOL	MIN.	TYP.	MAX.	UNITS	TEST CONDITIONS
Surge isolation voltage	V_{ISO}	6000			V_{Peak}	1 Minute
Steady-state isolation voltage	V_{ISO}	5300			V_{RMS}	1 Minute
Isolation resistance	R_{ISO}	10^{11}			ohms	$V_{i,o}=500\text{ VDC}$
Isolation capacitance	C_{ISO}		0.5		pF	$V_{i,o}=0, f=1\text{ MHz}$

TYPICAL ELECTRICAL CHARACTERISTIC CURVES
(25°C Free Air Temperature Unless Otherwise Specified)

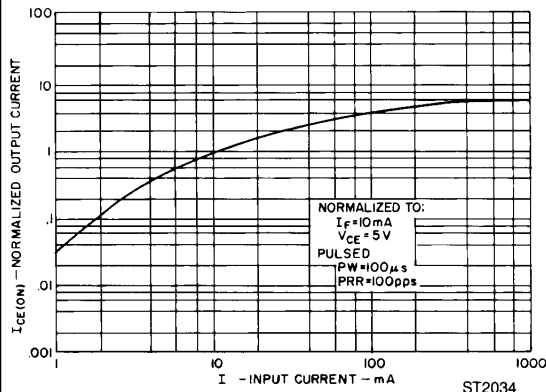

Fig. 1. Output Current vs. Input Current

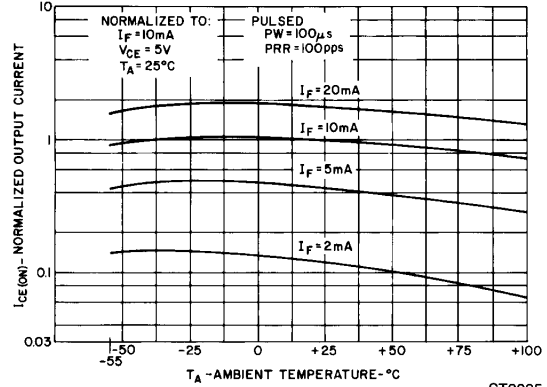

Fig. 2. Output Current vs. Temperature

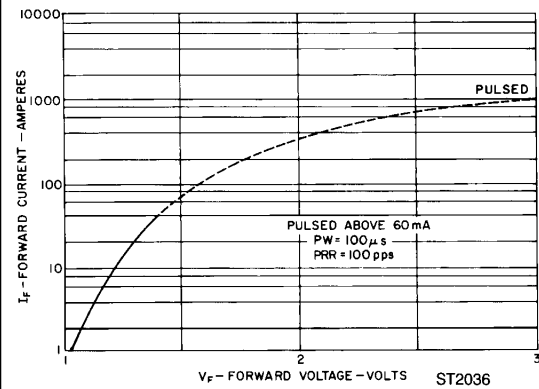

Fig. 3. Input Characteristics

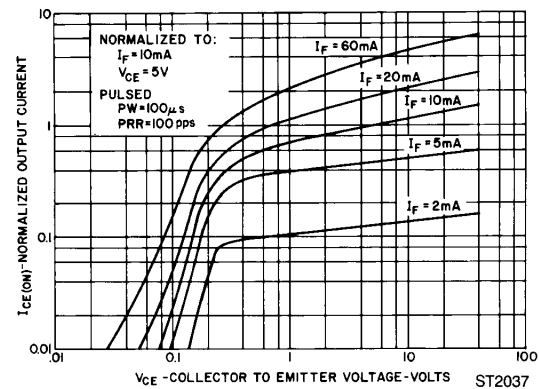

Fig. 4. Output Characteristics

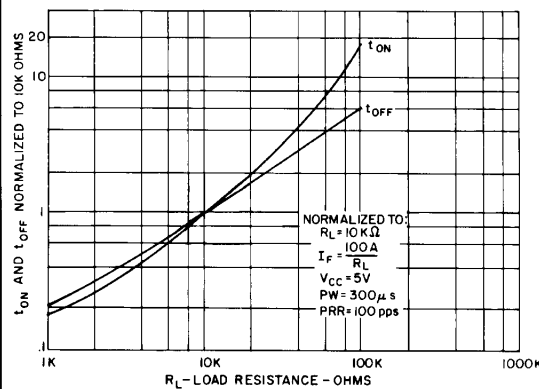

Fig. 5. Switching Speed vs. R_L

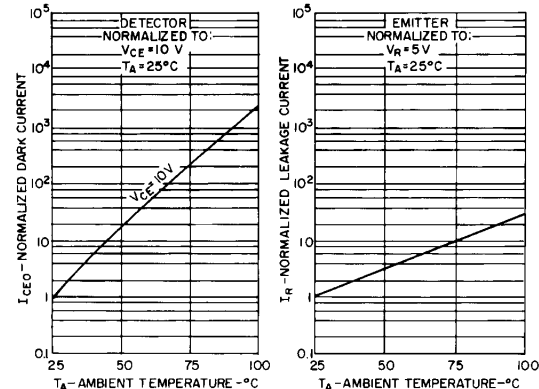

Fig. 6. Leakage Current vs. Temperature



PHOTOTRANSISTOR OPTOCOUPERS

DISCLAIMER

FAIRCHILD SEMICONDUCTOR RESERVES THE RIGHT TO MAKE CHANGES WITHOUT FURTHER NOTICE TO ANY PRODUCTS HEREIN TO IMPROVE RELIABILITY, FUNCTION OR DESIGN. FAIRCHILD DOES NOT ASSUME ANY LIABILITY ARISING OUT OF THE APPLICATION OR USE OF ANY PRODUCT OR CIRCUIT DESCRIBED HEREIN; NEITHER DOES IT CONVEY ANY LICENSE UNDER ITS PATENT RIGHTS, NOR THE RIGHTS OF OTHERS.

LIFE SUPPORT POLICY

FAIRCHILD'S PRODUCTS ARE NOT AUTHORIZED FOR USE AS CRITICAL COMPONENTS IN LIFE SUPPORT DEVICES OR SYSTEMS WITHOUT THE EXPRESS WRITTEN APPROVAL OF THE PRESIDENT OF FAIRCHILD SEMICONDUCTOR CORPORATION. As used herein:

1. Life support devices or systems are devices or systems which, (a) are intended for surgical implant into the body, or (b) support or sustain life, and (c) whose failure to perform when properly used in accordance with instructions for use provided in the labeling, can be reasonably expected to result in a significant injury of the user.
2. A critical component in any component of a life support device or system whose failure to perform can be reasonably expected to cause the failure of the life support device or system, or to affect its safety or effectiveness.