

## Rochester Electronics Manufactured Components

Rochester branded components are manufactured using either die/wafers purchased from the original suppliers or Rochester wafers recreated from the original IP. All recreations are done with the approval of the OCM.

Parts are tested using original factory test programs or Rochester developed test solutions to guarantee product meets or exceed the OCM data sheet.

## Quality Overview

- ISO-9001
- AS9120 certification
- Qualified Manufacturers List (QML) MIL-PRF-35835
  - Class Q Military
  - Class V Space Level
- Qualified Suppliers List of Distributors (QSLD)
  - Rochester is a critical supplier to DLA and meets all industry and DLA standards.

Rochester Electronics, LLC is committed to supplying products that satisfy customer expectations for quality and are equal to those originally supplied by industry manufacturers.

The original manufacturer's datasheet accompanying this document reflects the performance and specifications of the Rochester manufactured version of this device. Rochester Electronics guarantees the performance of its semiconductor products to the original OEM specifications. 'Typical' values are for reference purposes only. Certain minimum or maximum ratings may be based on product characterization, design, simulation, or sample testing.

# DM7556/DM8556 TRI-STATE® Programmable Binary Counters

## General Description

These circuits are synchronous, edge-sensitive, fully-programmable 4-bit counters. The counters feature both conventional totem-pole and TRI-STATE outputs; such that when the outputs are in the high impedance mode, they can be used to enter data from the bus lines. In addition, the clear input operates completely independent of all other inputs. During the programming operation, data is loaded into the flip-flops on the positive-going edge of the clock pulse. To facilitate cascading of these counters, the MAX COUNT output can be tied directly into the count enable input of the next counter.

## Features

- Typical clock frequency 35 MHz
- TRI-STATE outputs
- Fully independent clear
- Synchronous loading
- Cascading circuitry provided internally

## Connection Diagram

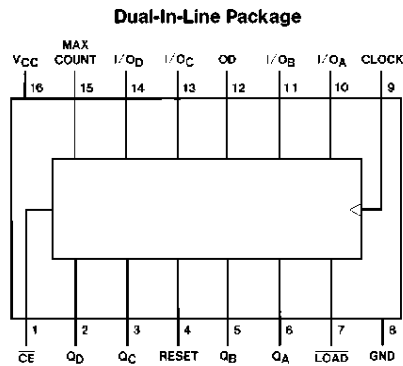

TL/F/6588-1

Order Number **DM7556J** or **DM8556N**  
See NS Package Number J16A or N16A

## Function Table

Control Inputs					I/O Ports				Active Outputs			
LOAD	CE	CLK	OD	Reset	I/O <sub>A</sub>	I/O <sub>B</sub>	I/O <sub>C</sub>	I/O <sub>D</sub>	Q <sub>A</sub>	Q <sub>B</sub>	Q <sub>C</sub>	Q <sub>D</sub>
H	X	X	L	H	L	L	L	L	L	L	L	L
H	X	X	H	H	Z	Z	Z	Z	L	L	L	L
H	X	L	L	L	Q <sub>A0</sub>	Q <sub>B0</sub>	Q <sub>C0</sub>	Q <sub>D0</sub>	Q <sub>A0</sub>	Q <sub>B0</sub>	Q <sub>C0</sub>	Q <sub>D0</sub>
H	X	L	H	L	Z	Z	Z	Z	Q <sub>A0</sub>	Q <sub>B0</sub>	Q <sub>C0</sub>	Q <sub>D0</sub>
L	H	↑	L	L	a	b	c	d	A	B	C	D
H	L	↑	L	L	COUNT				COUNT			
H	L	↑	H	L	Z	Z	Z	Z	COUNT			

The I/O pins are used as inputs when they are TRI-STATE, and the LOAD input is Low. They are outputs and active when LOAD input is High and OD is Low.

H = High Level (Steady State)

L = Low Level (Steady State)

X = Don't Care including transitions

a, b, c, d = The level of the steady state input at inputs A, B, C, D respectively

Q<sub>A0</sub>, Q<sub>B0</sub>, Q<sub>C0</sub>, Q<sub>D0</sub> = The level of Q<sub>A</sub>, Q<sub>B</sub>, Q<sub>C</sub>, Q<sub>D</sub> respectively, before the indicated steady state input conditions were established.

TRI-STATE® is a registered trademark of the National Semiconductor Corporation.

## Absolute Maximum Ratings (Note)

If Military/Aerospace specified devices are required, please contact the National Semiconductor Sales Office/Distributors for availability and specifications.

Supply Voltage	7V
Input Voltage	5.5V
Operating Free Air Temperature Range	
DM75	−55°C to +125°C
DM85	0°C to +70°C
Storage Temperature Range	−65°C to +150°C

Note: The "Absolute Maximum Ratings" are those values beyond which the safety of the device cannot be guaranteed. The device should not be operated at these limits. The parametric values defined in the "Electrical Characteristics" table are not guaranteed at the absolute maximum ratings. The "Recommended Operating Conditions" table will define the conditions for actual device operation.

## Recommended Operating Conditions

Symbol	Parameter		DM7556			DM8556			Units
			Min	Nom	Max	Min	Nom	Max	
V <sub>CC</sub>	Supply Voltage		4.5	5	5.5	4.75	5	5.25	V
V <sub>IH</sub>	High Level Input Voltage		2			2			V
V <sub>IL</sub>	Low Level Input Voltage				0.8			0.8	V
I <sub>OH</sub>	High Level Output Current				−2			−5.2	mA
I <sub>OL</sub>	Low Level Output Current				16			16	mA
f <sub>CLK</sub>	Clock Frequency (Note 1)		0		25	0		25	MHz
t <sub>w</sub>	Pulse Width (Note 1)	Clock	25			25			ns
		Clear	20			20			
		Load	30			30			
t <sub>CE</sub>	Count Enable Time (Note 1)	Setup	30			30			ns
		Hold	−10			−10			
t <sub>SETUP(1)</sub>	Setup Time High Logic Level (Note 1)	Data	25			25			ns
		Load	30			30			
t <sub>HOLD(1)</sub>	Hold Time High Logic Level (Note 1)	Data	5			5			ns
		Load	−10			−10			
t <sub>SETUP(0)</sub>	Setup Time Low Logic Level (Note 1)	Data	30			30			ns
		Load	25			25			
t <sub>HOLD(0)</sub>	Hold Time Low Logic Level (Note 1)	Data	5			5			ns
		Load	−10			−10			
T <sub>A</sub>	Free Air Operating Temperature		−55		125	0		70	°C

Note 1: T<sub>A</sub> = 25°C and V<sub>CC</sub> = 5V.

## Electrical Characteristics over recommended operating free air temperature range (unless otherwise noted)

Symbol	Parameter	Conditions	Min	Typ (Note 1)	Max	Units	
$V_I$	Input Clamp Voltage	$V_{CC} = \text{Min}, I_I = -12 \text{ mA}$			-1.5	V	
$V_{OH}$	High Level Output Voltage	$V_{CC} = \text{Min}, I_{OH} = \text{Max}$ $V_{IL} = \text{Max}, V_{IH} = \text{Min}$	2.4			V	
$V_{OL}$	Low Level Output Voltage	$V_{CC} = \text{Min}, I_{OL} = \text{Max}$ $V_{IH} = \text{Min}, V_{IL} = \text{Max}$			0.4	V	
$I_I$	Input Current @ Max Input Voltage	$V_{CC} = \text{Max}, V_I = 5.5\text{V}$			1	mA	
$I_{IH}$	High Level Input Current	$V_{CC} = \text{Max}, V_I = 2.4\text{V}$			40	$\mu\text{A}$	
$I_{IL}$	Low Level Input Current	$V_{CC} = \text{Max}, V_I = 0.4\text{V}$			-1.6	mA	
$I_{OZH}$	Off-State Output Current with High Level Output Voltage Applied	$V_{CC} = \text{Max}, V_O = 2.4\text{V}$ $V_{IH} = \text{Min}, V_{IL} = \text{Max}$			40	$\mu\text{A}$	
$I_{OZL}$	Off-State Output Current with Low Level Output Voltage Applied	$V_{CC} = \text{Max}, V_O = 0.4\text{V}$ $V_{IH} = \text{Min}, V_{IL} = \text{Max}$			-40	$\mu\text{A}$	
$I_{OS}$	Short Circuit Output Current	$V_{CC} = \text{Max}$ (Note 2)	DM75	-25		-70	mA
			DM85	-25		-70	
$I_{CC}$	Supply Current	$V_{CC} = \text{Max}$		75	100	mA	

Note 1: All typicals are at  $V_{CC} = 5\text{V}, T_A = 25^\circ\text{C}$ .

Note 2: Not more than one output should be shorted at a time.

## Switching Characteristics at $V_{CC} = 5\text{V}$ and $T_A = 25^\circ\text{C}$ (See Section 1 for Test Waveforms and Output Load)

Symbol	Parameter	From (Input) To (Output)	$R_L = 400\Omega$				Units
			$C_L = 5 \text{ pF}$		$C_L = 50 \text{ pF}$		
			Min	Max	Min	Max	
$f_{MAX}$	Maximum Clock Frequency				25	MHz	
$t_{PLH}$	Propagation Delay Time Low to High Level Output	Clock to Output				22	ns
$t_{PHL}$	Propagation Delay Time High to Low Level Output	Clock to Output				44	ns
$t_{PLH}$	Propagation Delay Time Low to High Level Output	Clock to MAX-CNT				33	ns
$t_{PHL}$	Propagation Delay Time High to Low Level Output	Clock to MAX-CNT				33	ns
$t_{PHL}$	Propagation Delay Time High to Low Level Output	Reset to Output				44	ns
$t_{pZH}$	Output Enable Time to High Level Output	Output Disable to Q				20	ns
$t_{pZL}$	Output Enable Time to Low Level Output	Output Disable to Q				20	ns
$t_{PHZ}$	Output Disable Time from High Level Output	Output Disable to Q		12			ns
$t_{PLZ}$	Output Disable Time from Low Level Output	Output Disable to Q		20			ns

# Logic Diagram

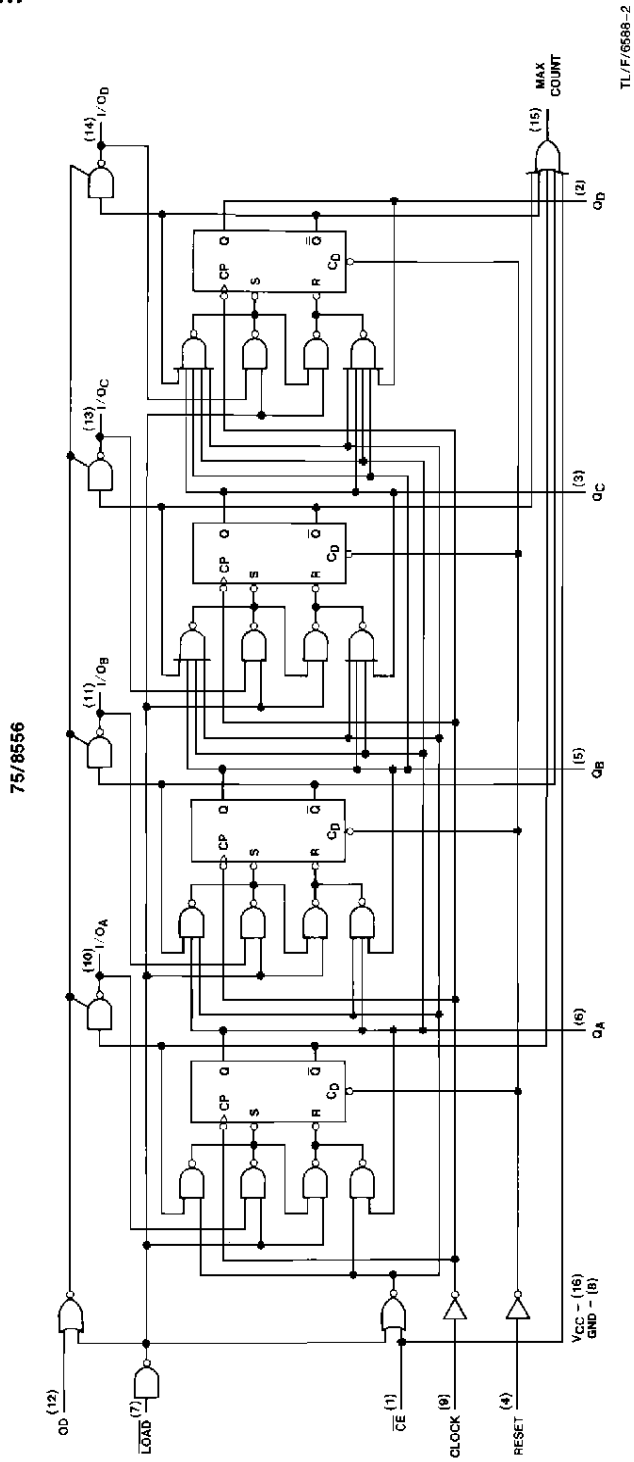

# Timing Diagram

75/8556 Typical Clear, Preset, Count, Inhibit Sequence

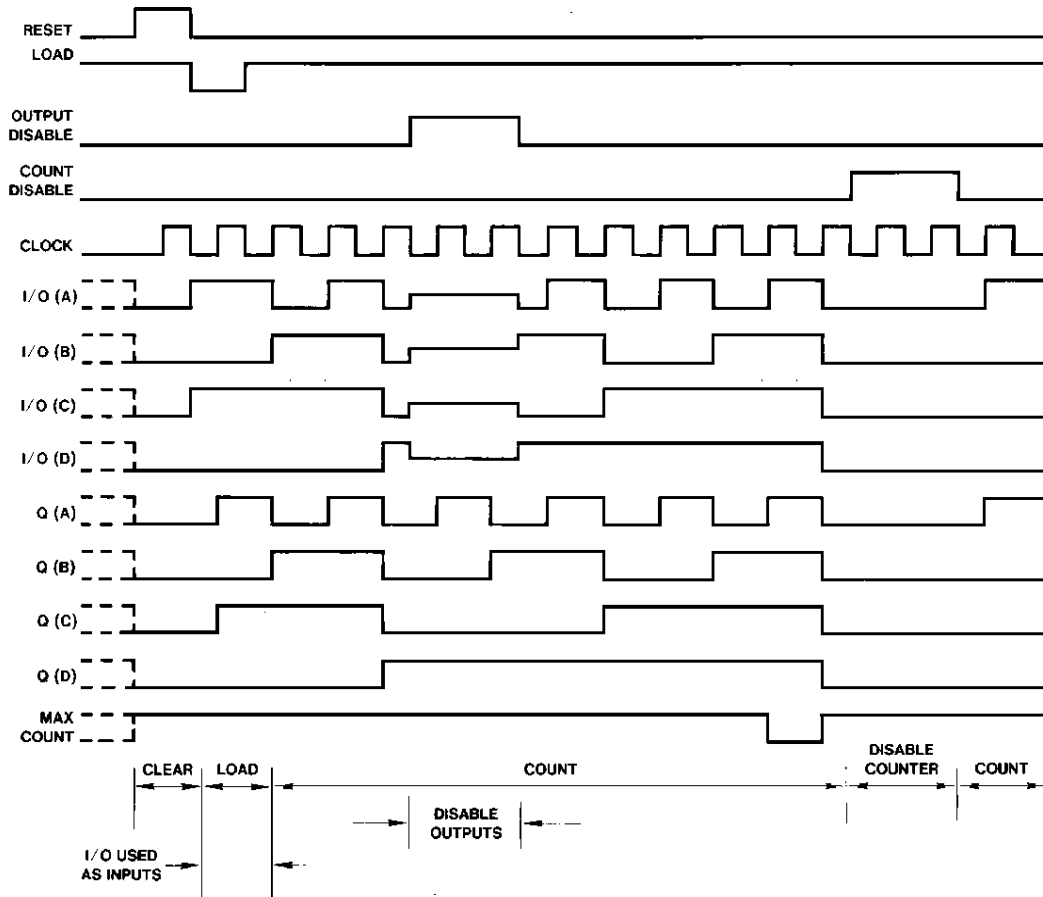

TL/F/6588-3

### Sequence

- (1) Clear to zero.
- (2) Load binary five.
- (3) Count six, seven, eight, nine, ten, eleven, twelve, thirteen, fourteen, fifteen, zero.
- (4) Disable TRI-STATE outputs.
- (5) Disable counter.
- (6) Count to one.

# Switching Time Waveforms

**Clock and Reset Voltage**

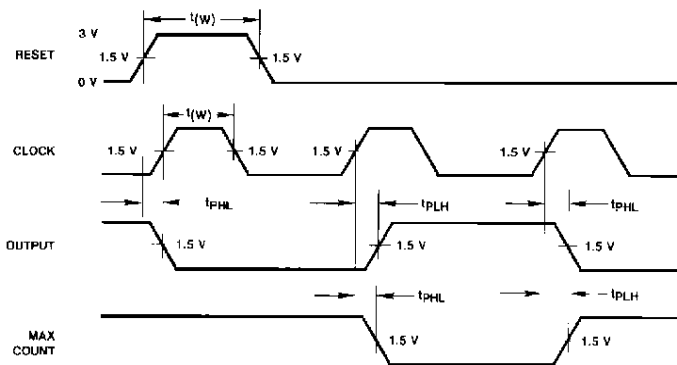

TL/F/6588-4

**Count Enable and Clock**

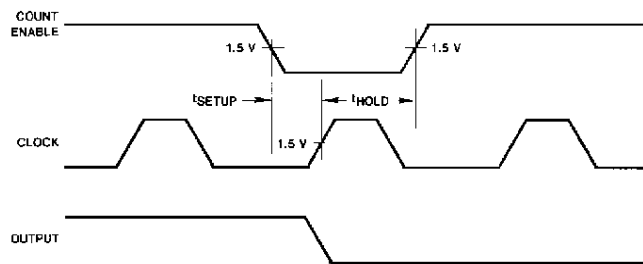

TL/F/6588-5

**Load, Data and Clock**

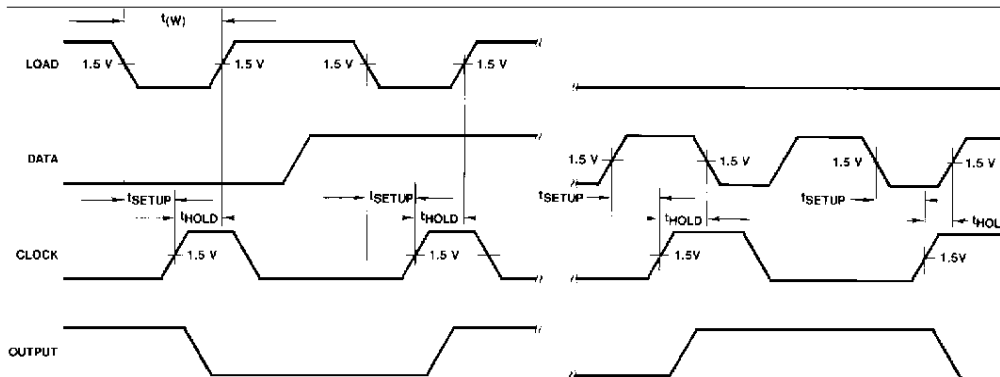

TL/F/6588-6

**Output Disable**

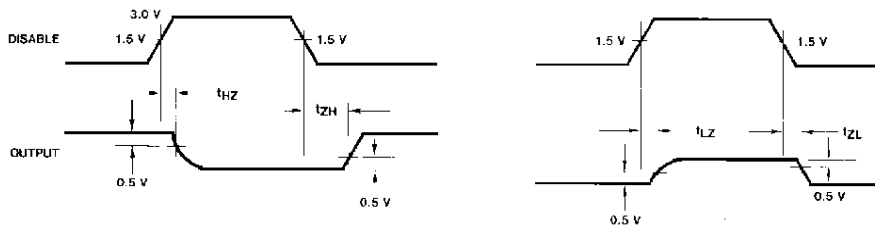

TL/F/6588-7

**Physical Dimensions** inches (millimeters)

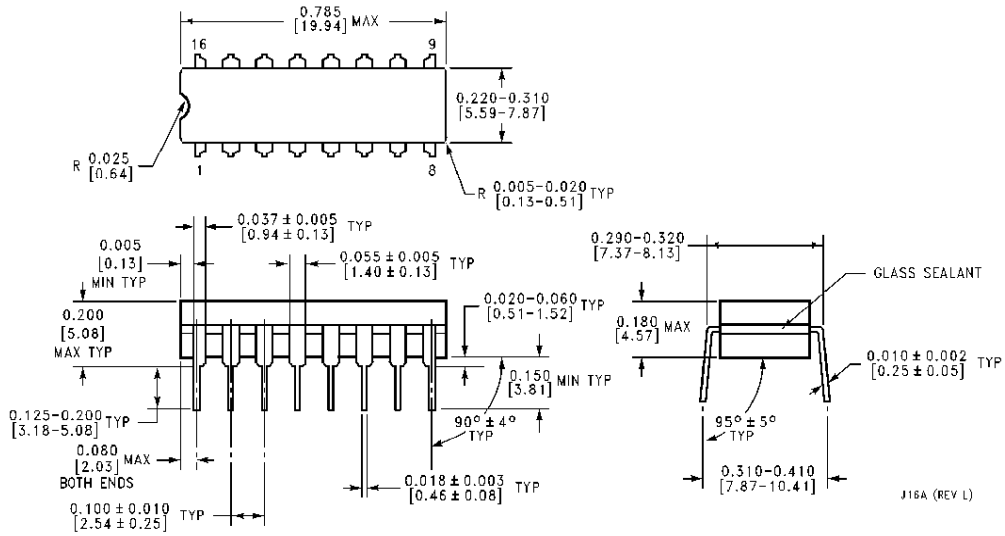

**Ceramic Dual-In-Line Package (J)**  
**Order Number DM7556J**  
**NS Package Number J16A**

J16A (REV L)



**Physical Dimensions** inches (millimeters) (Continued)

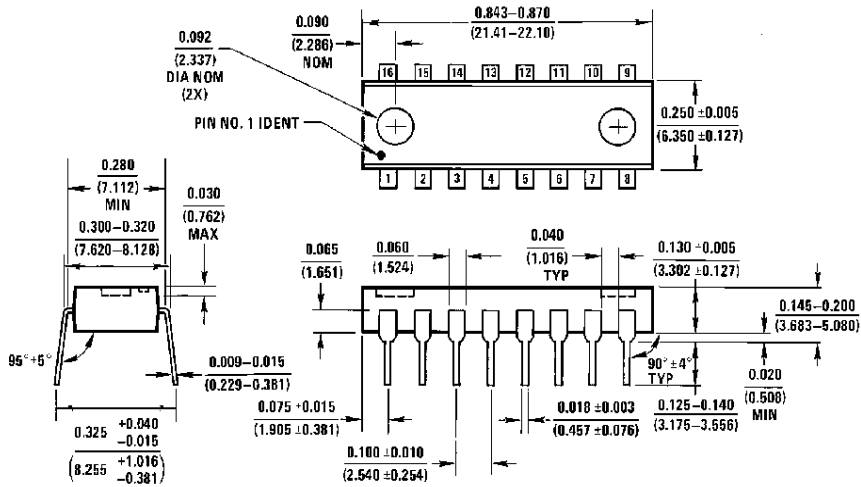

**Molded Dual-In-Line Package (N)**  
**Order Number DM8556N**  
**NS Package Number N16A**

N16A (REV E)

**LIFE SUPPORT POLICY**

NATIONAL'S PRODUCTS ARE NOT AUTHORIZED FOR USE AS CRITICAL COMPONENTS IN LIFE SUPPORT DEVICES OR SYSTEMS WITHOUT THE EXPRESS WRITTEN APPROVAL OF THE PRESIDENT OF NATIONAL SEMICONDUCTOR CORPORATION. As used herein:

1. Life support devices or systems are devices or systems which, (a) are intended for surgical implant into the body, or (b) support or sustain life, and whose failure to perform, when properly used in accordance with instructions for use provided in the labeling, can be reasonably expected to result in a significant injury to the user.
2. A critical component is any component of a life support device or system whose failure to perform can be reasonably expected to cause the failure of the life support device or system, or to affect its safety or effectiveness.



**National Semiconductor Corporation**  
 1111 West Bardin Road  
 Arlington, TX 76017  
 Tel: 1(800) 272-9959  
 Fax: 1(800) 737-7018

**National Semiconductor Europe**  
 Fax: (+49) 0-180-530 85 86  
 Email: cnjwge@tevm2.nsc.com  
 Deutsch Tel: (+49) 0-180-530 85 85  
 English Tel: (+49) 0-180-532 78 32  
 Français Tel: (+49) 0-180-532 93 58  
 Italiano Tel: (+49) 0-180-534 16 80

**National Semiconductor Hong Kong Ltd.**  
 13th Floor, Straight Block,  
 Ocean Centre, 5 Canton Rd.  
 Tsimshatsui, Kowloon  
 Hong Kong  
 Tel: (852) 2737-1600  
 Fax: (852) 2736-9960

**National Semiconductor Japan Ltd.**  
 Tel: 81-043-299-2309  
 Fax: 81-043-299-2408

National does not assume any responsibility for use of any circuitry described, no circuit patent licenses are implied and National reserves the right at any time without notice to change said circuitry and specifications.