

8x8 G click™

1. Introduction

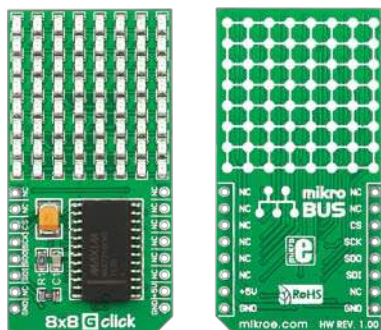

8x8 G Click™ is an accessory board in **mikroBUS™** form factor. It's a compact and easy solution for adding 8x8 **GREEN** LED matrix to your design. It features **MAX7219** 8-digit LED display driver module as well as 64 **GREEN** LED diodes. 8x8 G Click™ communicates with target board microcontroller via four **mikroBUS™** SPI lines (DIN, DOUT, CLK and CS). The board is designed to use 5V power supply only, but it can be used with 3.3V MCUs as well.

2. Soldering the headers

Before using your click board™, make sure to solder 1x8 male headers to both left and right side of the board. Two 1x8 male headers are included with the board in the package.

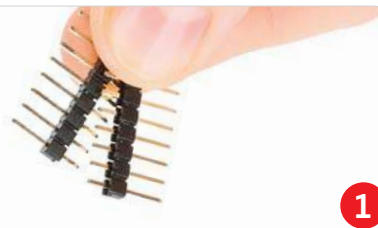

2

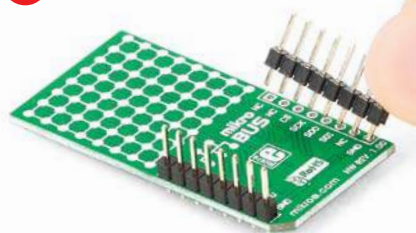

Turn the board upside down so that bottom side is facing you upwards. Place shorter parts of the header pins in both soldering pad locations.

3

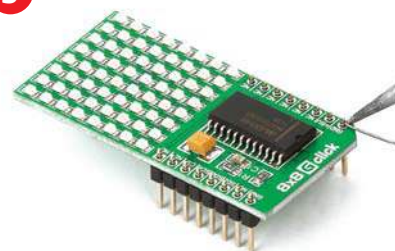

Turn the board upward again. Make sure to align the headers so that they are perpendicular to the board, then solder the pins carefully.

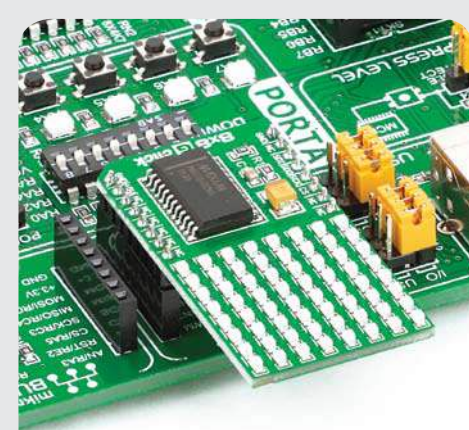

4. Essential features

8x8 G Click™ with its **MAX7219** IC gives additional 8x8 **GREEN** LED matrix to your design. The **MAX7219** is serial input/output common-cathode display driver with SPI interface. It has BCD code-B decoder, analog and digital brightness control, 8x8 static RAM and several useful registers.

3. Plugging the board in

Once you have soldered the headers your board is ready to be placed into desired mikroBUS™ socket. Make sure to align the cut in the lower-right part of the board with the markings on the silkscreen at the mikroBUS™ socket. If all of the pins are aligned correctly, push the board all the way into the socket.

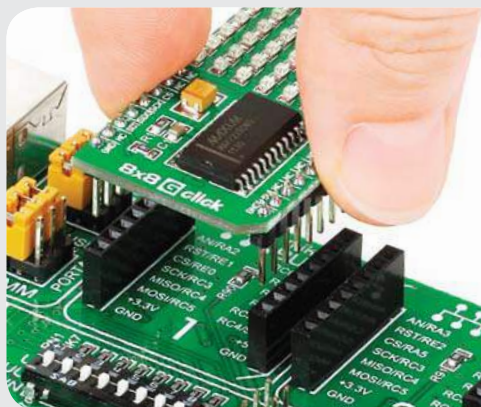

click™
BOARD
www.mikroe.com

8x8 G click Manual
ver. 1.00



5. 8x8 G Click™ Board Schematic

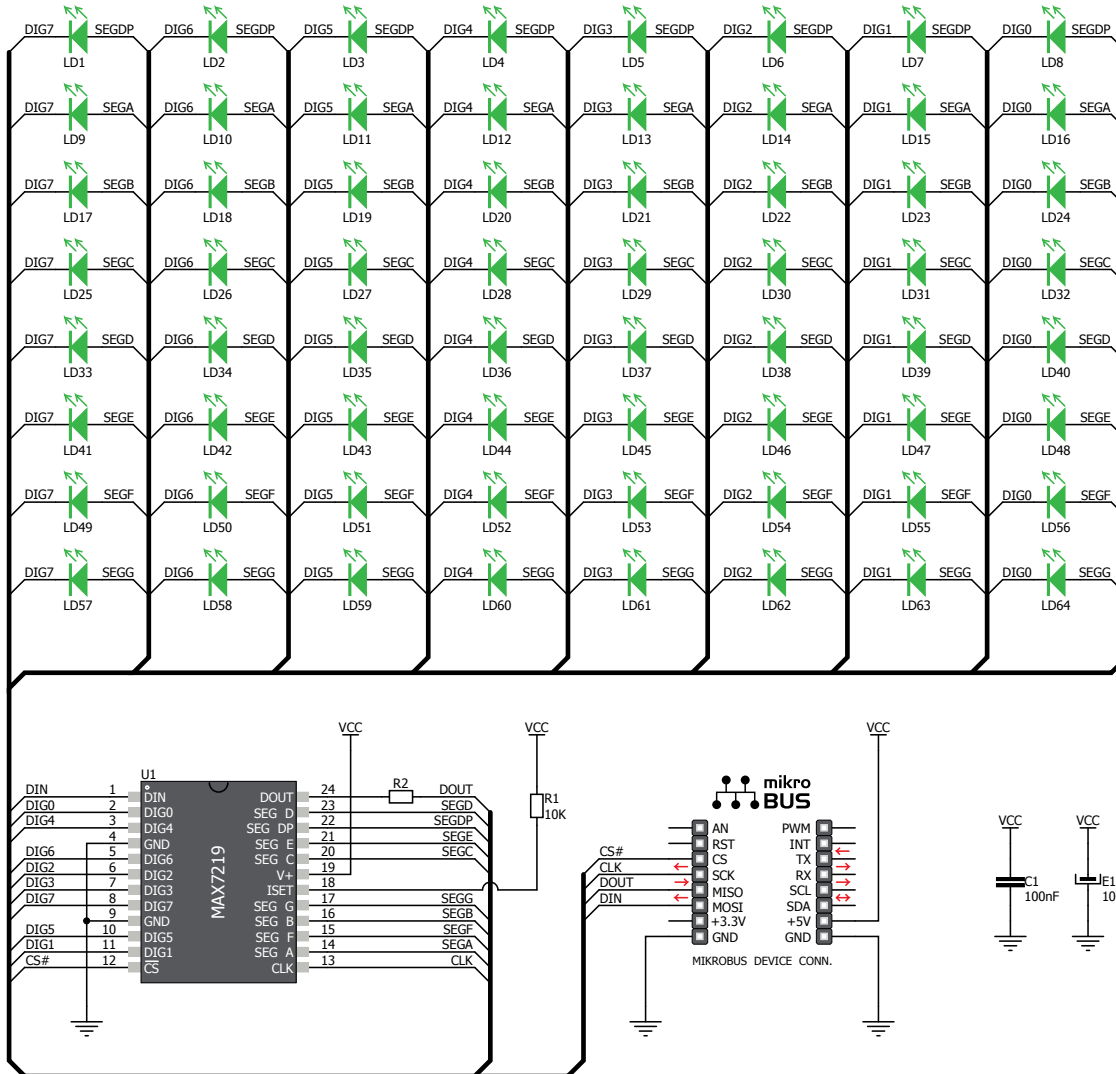

6. LED diodes

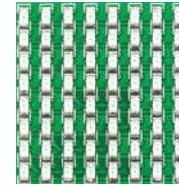

There are four 8x8 Click™ boards which differ from each other by color of LEDs (red, green, blue, yellow). For more details look at following address:

<http://www.mikroe.com/click/>

7. Code Examples

Once you have done all the necessary preparations, it's time to get your click board up and running. We have provided the examples for mikroC, mikroBasic and mikroPascal compilers on our **Libstock** website. Just download them and you are ready to start.



8. Support

MikroElektronika offers **Free Tech Support** (www.mikroe.com/esupport) until the end of product lifetime, so if something goes wrong, we are ready and willing to help!