

SB520E-G Thru. SB5100E-G

Voltage: 20 to 100 V

Current: 5.0 A

RoHS Device



Features

- Low drop down voltage.
- 5.0A operation at TA=75°C with no thermal runaway
- For use in low voltage, high frequency invertors free wheeling and polarity protection.
- Silicon epitaxial planar chips.
- ESD test under IEC6100-4-2 : Standard: >15KV(Air) & 8KV(Contact)
- Lead-free part, meet RoHS requirements.

Mechanical data

- Epoxy: UL94-V0 rated flame retardant
- Case: Molded plastic body DO-201AD
- Terminals: Solderable per MIL-STD-750 Method 2026
- Polarity: Color band denotes cathode end
- Mounting Position: Any
- Weight: 1.12 grams(approx.).

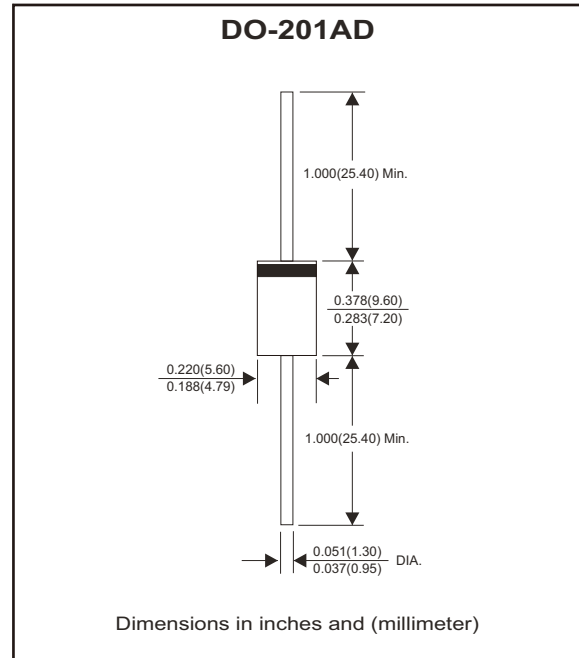

Circuit Diagram



Electrical Characteristics (at TA=25°C unless otherwise noted)

Ratings at 25°C ambient temperature unless otherwise specified.

Parameter	Symbol	SB 520E-G	SB 540E-G	SB 545E-G	SB 550E-G	SB 560E-G	SB 580E-G	SB 5100E-G	Unit
Maximum recurrent peak reverse voltage	V _{RRM}	20	40	45	50	60	80	100	V
Maximum RMS voltage	V _{RMS}	14	28	30	35	42	56	70	V
Maximum DC blocking voltage	V _{DC}	20	40	45	50	60	80	100	V
Maximum average forward rectified current 0.5" (12.7mm) lead length at TA=75°C, See Figure 1	I _(AV)	5.0							A
Peak forward surge current 8.3ms single half sine-wave superimposed on rated load (JEDEC method) T _L =110°C	I _{FSM}	150			125			A	
Maximum forward voltage at 5.0A (Note 1)	V _F	0.55		0.70		0.85		V	
Maximum DC reverse current At rated DC blocking voltage	I _R	0.5			30			mA	
Typical junction capacitance (Note 2)	C _J	500			pF				
Typical thermal resistance (Note 3)	R _{θJA} R _{θJL}	35.0 15.0			°C/W				
Operating junction temperature range	T _J	-65 to +125			-65 to +150			°C	
Storage temperature range	T _{STG}	-65 to +150							°C

NOTES:

1. Pulse test : 300µS pulse width, 1% duty cycle.
2. Measured at 1.0MHz and applied reverse voltage of 4.0 Volts.
3. Thermal resistance from junction to ambient and from junction to lead P.C.B. mounted 0.500" (12.7mm) lead length with 2.5x2.5" (63.5x63.5mm) copper pad.

Company reserves the right to improve product design , functions and reliability without notice.

REV:C

RATING AND CHARACTERISTIC CURVES (SB520E-G Thru. SB5100E-G)

Fig.1 - Forward Current Derating Curve

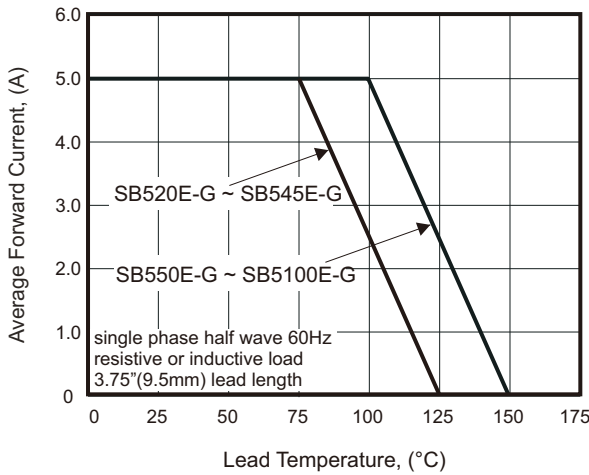

Fig.2 - Maximum Non-repetitive Peak Forward Surge Current

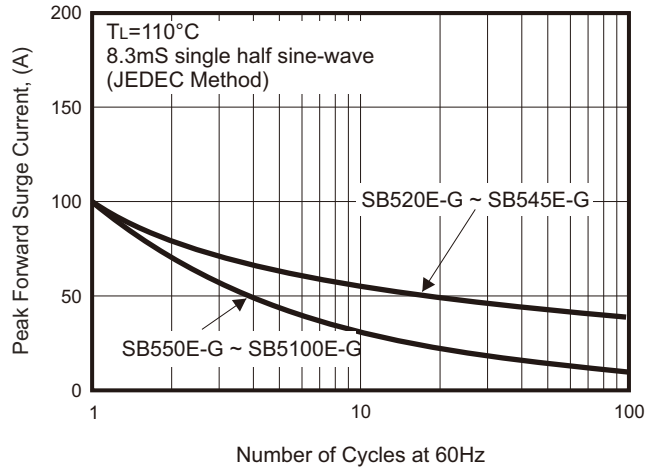

Fig.3 - Typical Instantaneous Forward Characteristics

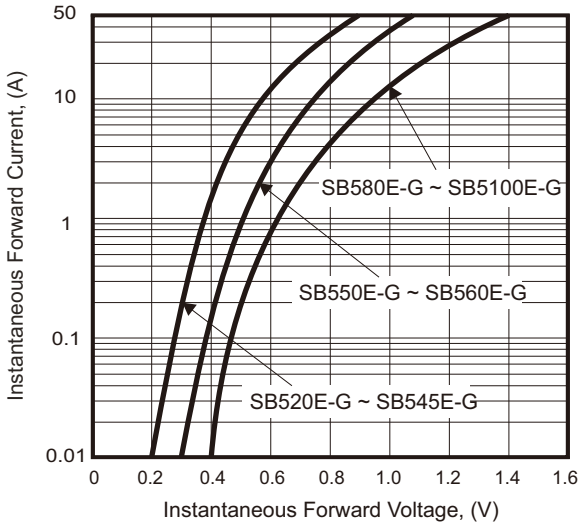

Fig.4A - Typical Reverse Characteristics

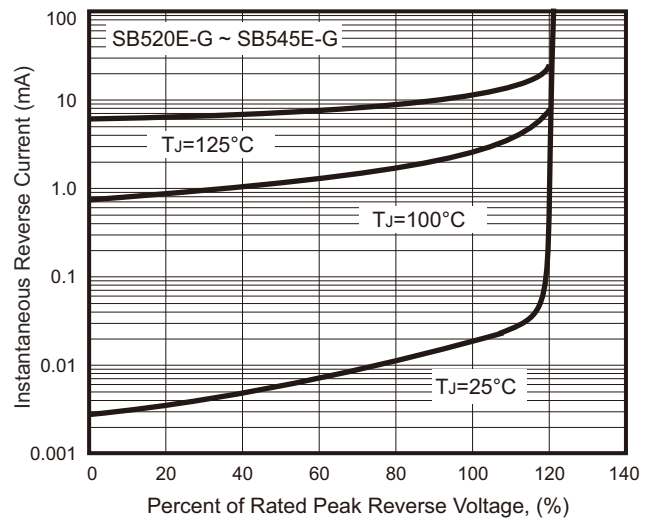

Fig.5 - Typical Junction Capacitance per leg

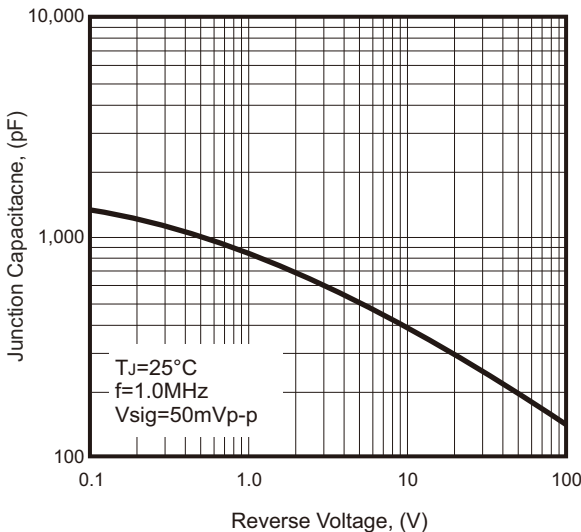
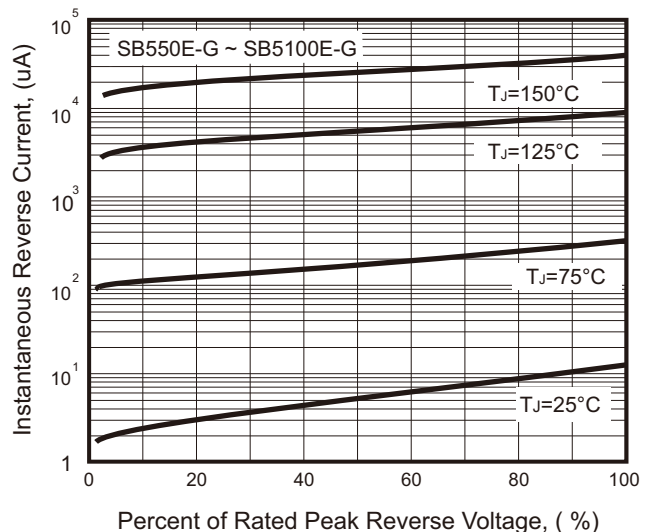
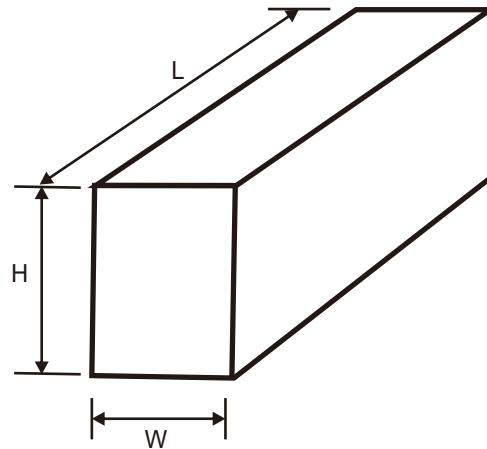
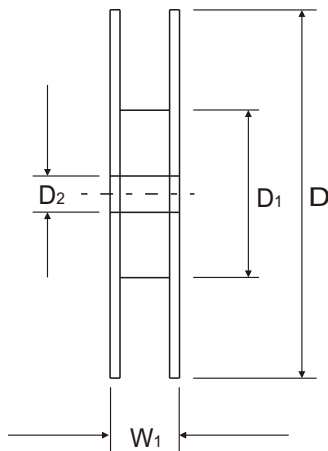
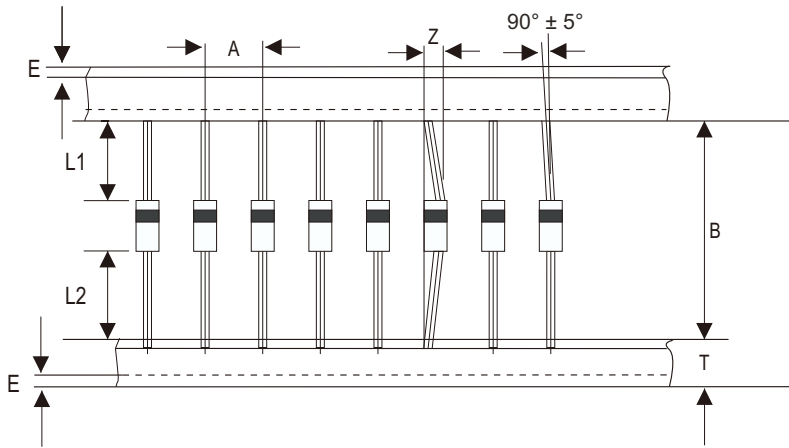

Fig.4B - Typical Reverse Characteristic



Taping Specification For Axial Lead Diodes



DO-210AD	SYMBOL	A	B	Z	T	E	L1-L2
	(mm)	10.00 ± 0.50	52.40 + 1.50 - 0.40	1.20 (max)	6.00 ± 0.40	0.80 (max)	1.00 (max)
	(inch)	0.394 ± 0.020	2.063 + 0.059 - 0.016	0.047 (max)	0.236 ± 0.016	0.031 (max)	0.039 (max)

DO-210AD	SYMBOL	L	W	H	D	D1	D2	W1
	(mm)	255.00 ± 5.00	75.00 ± 5.00	150.00 ± 5.00	330	85.70 ± 0.30	16.60 ± 0.40	79.00 ± 1.00
	(inch)	10.039 ± 0.197	2.953 ± 0.197	5.906 ± 0.197	12.992	3.374 ± 0.012	0.654 ± 0.016	3.110 ± 0.039

Marking Code

Part Number	Marking code	Packaging
SB520ET-G	SB520E	REEL
SB540ET-G	SB540E	REEL
SB545ET-G	SB545E	REEL
SB550ET-G	SB550E	REEL
SB560ET-G	SB560E	REEL
SB580ET-G	SB580E	REEL
SB5100ET-G	SB5100E	REEL
SB520EA-G	SB520E	AMMO
SB540EA-G	SB540E	AMMO
SB545EA-G	SB545E	AMMO
SB550EA-G	SB550E	AMMO
SB560EA-G	SB560E	AMMO
SB580EA-G	SB580E	AMMO
SB5100EA-G	SB5100E	AMMO
SB520EB-G	SB520E	BULK
SB540EB-G	SB540E	BULK
SB545EB-G	SB545E	BULK
SB550EB-G	SB550E	BULK
SB560EB-G	SB560E	BULK
SB580EB-G	SB580E	BULK
SB5100EB-G	SB5100E	BULK

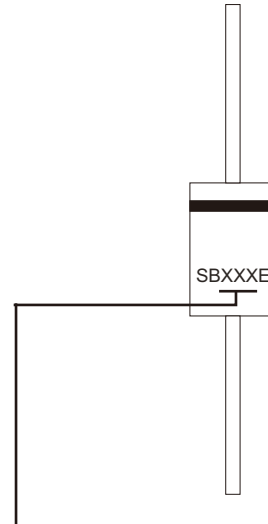

XXX / XXXX = Product type marking code

Note:

1) Suffix code after part number to specify packaging item .

Packaging	Code
REEL PACK	T
AMMO PACK	A
BULK PACK	B

Standard Packaging

Case Type	REEL PACK	
	REEL (pcs)	Reel Size (inch)
DO-201AD	1,200	13

Case Type	BULK PACK
	BOX (pcs)
DO-201AD	200

Case Type	AMMO PACK
	BOX (pcs)
DO-201AD	1,200