

K70 Wireless Battery-Powered Touch Button



Datasheet

Sure Cross® K70 Wireless Battery-Powered Touch Button combines the best of Banner's popular touch button family with its reliable, field-proven, Sure Cross wireless architecture.

This self-contained, fully wireless device consists of a bidirectional radio transmitter with an on-board capacitive touch button and four colored LEDs powered by a single lithium battery. The K70 wireless battery-powered touch button offers superior mounting flexibility as it can be placed almost anywhere, regardless of availability of power. Multicolored LEDs allow for communicating multiple statuses with a single device and a capacitive touch button gives users the ability to provide remote feedback/communication.



- Self-contained battery-powered touch button
- Up to four colors in one device: green, red, yellow, and blue, with additional colors available by blending
- Available in 900 MHz and 2.4 GHz ISM radio frequencies
- Rugged, water-resistant IP65 housing with UV-stabilized material
- Bright, uniform indicator segments appear gray when off to eliminate false indication from ambient light
- Excellent immunity to false triggering by water spray, detergents, oils, and other foreign materials
- Ergonomically designed to eliminate hand, wrist, and arm stresses associated with repeated switch operation; requires no physical force to operate

Models

Model	Frequency	Colors	Power
K70DXN9T2GRYBX-B	900 MHz ISM Band	Green, Red, Yellow, Blue	3.6 V DC C cell Battery
K70DXN2T2GRYBX-B	2.4 GHz ISM Band		

To order integrated battery models without the battery, add **NB** to the model number (for example, **K70DXN9T2GRYBX-B NB**). If you purchase a model without the battery, Banner Engineering recommends battery model **BWA-BATT-013**.

Quick Start Guide

Continue reading the datasheet for more detailed instructions.

1. Set the DIP switches.
2. Install the battery.
The radio powers on automatically.
3. Bind the K70 to its Gateway (DXM Controller or DX80 Performance Gateway) and assign a Node ID to the K70.
4. Mount the K70.
5. Collect the data with the DXM Controller or Gateway from Input 1 (touch button status).
6. Control the color status by turning on outputs 1 through 4 for the green, red, yellow, and blue LEDs respectively.

Overview

The K70 Wireless Battery-Powered Touch Button is pre-configured to work as a toggle switch with instant feedback. While the button is touched, the green LED is on and flashes after it is released. The button can be touched again to turn off the flashing green LED or it can be controlled wirelessly to turn off or change another color.



Configuration Instructions

Assembling the K70

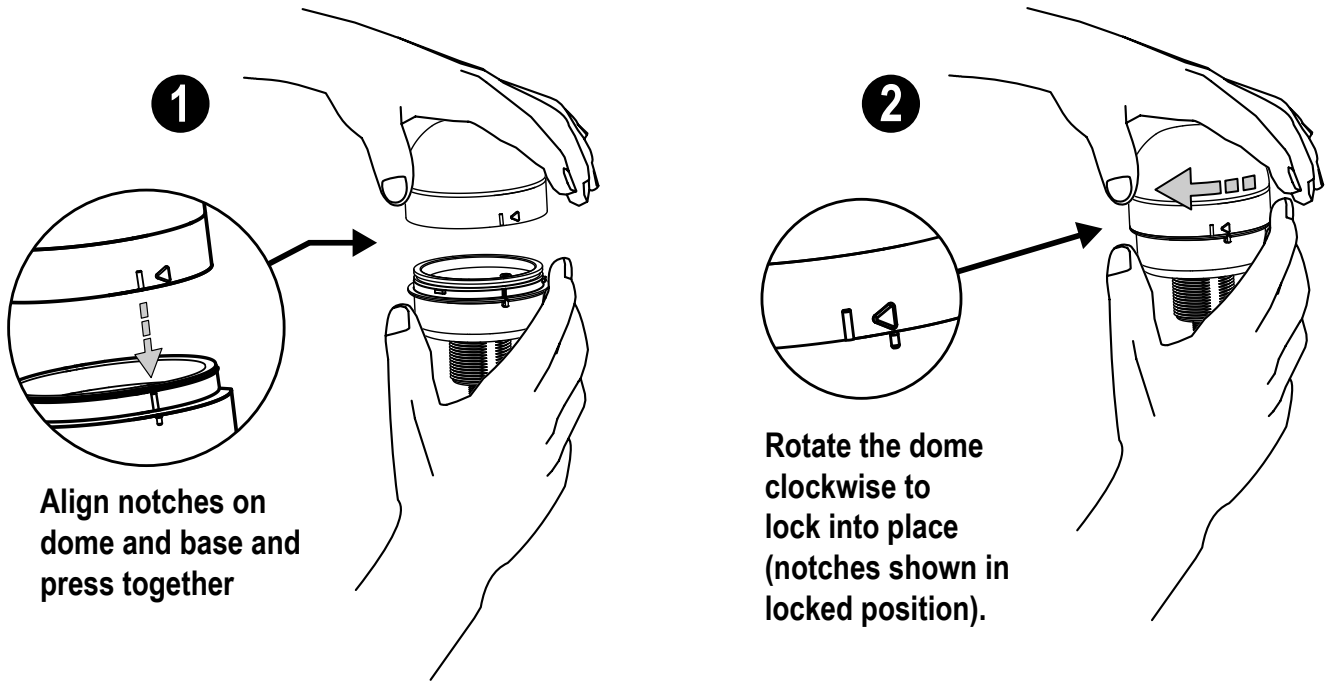

Set the Radio Module DIP Switches

Before applying power to the device, set the radio module's DIP switches. Default configurations are noted with (*). After changing DIP switch positions, cycle power to the device for the changes to take effect. To cycle power, triple-click the binding button. After the status LEDs alternately flash red and green, then double-click the binding button.

Figure 1. DIP switch location on the board

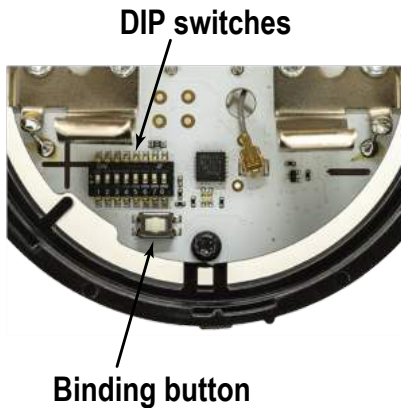

Table 1: DIP switches

Device Settings	DIP Switches							
	1	2	3	4	5	6	7	8
Transmit Power Level (900 MHz only): 1 Watt (30 dBm)	ON*							
Transmit Power Level (900 MHz only): 250 mW (24 dBm), DX80 Compatibility mode	OFF							
Touch Button Function: Toggle		ON*	ON*					
Touch Button Function: Momentary		OFF	ON					
Touch Button Function: Latch		ON	OFF					
Touch Button Function: Rising/Falling Edge Counter		OFF	OFF					
Touch Feedback Control: Green				ON*	ON*	ON*		
Touch Feedback Control: Red				OFF	ON	ON		
Touch Feedback Control: Blue				ON	OFF	ON		

Device Settings	DIP Switches							
	1	2	3	4	5	6	7	8
Touch Feedback Control: Yellow				OFF	OFF	ON		
Touch Feedback Control: White				ON	ON	OFF		
Touch Feedback Control: Cyan				OFF	ON	OFF		
Touch Feedback Control: Magenta				ON	OFF	OFF		
No Feedback				OFF	OFF	OFF		
Control Mode: Default Mode							ON*	ON*
Control Mode: Single Register Mode							OFF	ON
Control Mode: Pick Mode							ON	OFF
Control Mode: Demo Mode							OFF	OFF

Radio Transmit Power—The 900 MHz radios transmit at 1 Watt (30 dBm) or 250 mW (24 dBm). The 250 mW mode reduces the radio's range but improves the battery life in short range applications. For 2.4 GHz models, this DIP switch is disabled. The transmit power for 2.4 GHz is fixed at about 65 mW EIRP (18 dBm).

Toggle—The input register toggles between a value of 0 (off) and 1 (on) with successive button presses or touches. Write a decimal value of 5377 to I/O 15 to clear the toggle to 0 or write a value of 5505 to alternate the current state of the toggle (0 to 1 or 1 to 0).

Momentary—The input register holds the value of the current state of the button. When the button is actively pressed or touched, the input register shows a value of 1. When the button is not pressed or touched, the input register shows a value of 0.

Latch—After an input is activated (register set to 1) with a button press or using Modbus messages, the input remains at 1 until cleared or alternated by writing a value of 5377 or 5505 respectively. Latching prevents a successive button press from setting the input back to 0.

For more details on Latch/Toggle controls, see the *Latch/Toggle Control for Push Button and Touch Button Inputs* technical note (p/n [b_51135628](#)).

Rising/Falling Edge Counter—The input register increments with each successive press. When the button is actively pressed or touched, the register increments by a value of 1, the register increments again by a value of 1 when the button is released. LEDs do not turn ON unless the touch feedback control is enabled and are only on while actively pressed or touched. Touch feedback for the LEDs follows Momentary touch functions.

Install or Replace the Battery

To replace the lithium "C" cell battery in the K70, follow these steps.

Figure 2. Install the battery as shown



1. Access the battery terminal by removing the dome. See [Assembling the K70](#) on p. 2.
2. If applicable, remove the discharged battery.
3. Install the new battery.
4. Verify the positive and negative terminals align to the positive and negative terminals of the battery holder mounted within the case.
5. Allow up to 60 seconds for the device to turn on, or you can press and hold the binding button for five seconds to turn on the device.
6. Properly dispose of used batteries according to local regulations by taking it to a hazardous waste collection site, an e-waste disposal center, or other facility qualified to accept lithium batteries.

Bind the K70 to the Gateway and Assign the Node Address

Before beginning the binding procedure, apply power to all the devices.

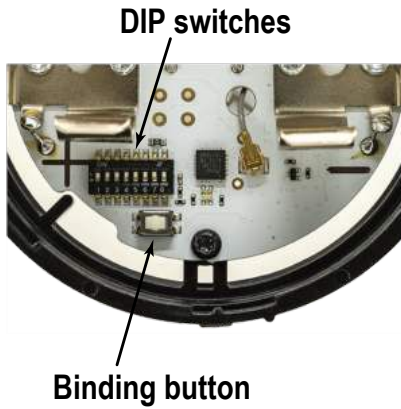

1. Enter binding mode.
 - For housed Gateways, triple-click button 2.
 - For board-level Gateway modules, triple-click the button.
 - For DXMs, under the **ISM Radio** menu, use the down arrow button to highlight the **Binding** menu. Click **ENTER**.

On the board modules, the green/red LED flashes. On the housed models, both LEDs flash red.
2. Assign the K70 a Node address using the Gateway's rotary dials or the DXM's arrow keys.
 - On a Gateway: Use the left rotary dial for the left digit and the right rotary dial for the right digit. For example, to assign your K70 to Node 01, set the left dial to 0 and the right dial to 1.
 - On the DXM: Use the arrow keys to select the Node ID, then press **ENTER**. The display shows **Binding**.

Valid Node addresses are 01 through 47.
3. Access the circuit board in the radio module of the K70.
4. Enter binding mode on the K70 by triple-clicking the binding button.

The bicolor LED flashes alternately while it searches for a Gateway in binding mode. After the K70 is bound, the LED is red and green for four seconds (looks amber), then it flashes four times (looks amber). The K70 automatically exits binding mode, cycles power, and enters Run mode.
5. For DXMs, click **BACK** to exit binding for that specific Node address.
6. Label the Node with the assigned address for future references.

This makes it easier to identify the physical Node location within a multi-Node network.
7. Reassemble the components back onto the base.
8. Repeat steps 2 through 5 for as many K70 Wireless Battery-Powered Touch Buttons as are needed for your network.
9. After binding all K70s, exit binding mode on the Gateway.
 - For housed Gateways, double-click button 2.
 - For board-level Gateway modules, double-click the button.
 - For DXM models, click **BACK** until you return to the main menu.

LED Behavior for the Nodes

Nodes do not sample inputs until they are communicating with the Gateway. The radios and antennas must be a minimum distance apart to function properly. Recommended minimum distances are:

- 900 MHz 150 mW and 250 mW radios: 6 feet
- 900 MHz 1 Watt radios: 15 feet
- 2.4 GHz 65 mW radios: 1 foot

LED (Bi-color)	Node Status
Flashing green	Radio link okay
Green and red flashing alternately	In Binding mode
Both colors are solid for 4 seconds, then flash 4 times; looks amber	Binding mode is complete
Flashing red, once every 3 seconds	Radio link error
Flashing red, once every second	Device error

Modbus Registers

Table 2: Default Modbus holding registers

I/O	Modbus Holding Registers		I/O Type	I/O Range		Holding Register Representation (Dec.)	
	Gateway	Any Node		Minimum	Maximum	Minimum	Maximum
1	1	1 + (Node# × 16)	Touch Input or Rising/Falling Edge Counter	0	65535	0	65535
		...					
7	7	7 + (Node# × 16)	Reserved				

I/O	Modbus Holding Registers		I/O Type	I/O Range		Holding Register Representation (Dec.)	
	Gateway	Any Node		Minimum	Maximum	Minimum	Maximum
8	8	8 + (Node# × 16)	Device Message				
9	9	9 + (Node# × 16)	Green light	0	1	0	1
10	10	10 + (Node# × 16)	Red light	0	1	0	1
11	11	11 + (Node# × 16)	Yellow light	0	1	0	1
12	12	12 + (Node# × 16)	Blue light	0	1	0	1
		...					
15	15	15 + (Node# × 16)	Control Message				
16	16	16 + (Node# × 16)	Reserved				

Table 3: Single register control or pick mode

I/O	Modbus Holding Registers		I/O Type	I/O Range		Holding Register Representation (Dec.)	
	Gateway	Node		Minimum	Maximum	Minimum	Maximum
1	1	1 + (Node# × 16)	Touch Input or Rising/Falling Edge Counter	0	65535	0	65535
		...					
6	6	6 + (Node# × 16)	Output Feedback	0	65535	0	65535
7	7	7 + (Node# × 16)	Reserved				
8	8	8 + (Node# × 16)	Device Message				
		...					
14	14	14 + (Node# × 16)	Single Register Control	0	65535	0	65535
15	15	15 + (Node# × 16)	Control Message				
16	16	16 + (Node# × 16)	Reserved				

Single register control—Single register control combines all the output registers from the default I/O mode into a single register.

Single register control word—Use the single register control word to simultaneously control the light functions with a single command. For example, a decimal value of 1024 flashes the green LED and turns off all other LEDs. A decimal value of 40960 turns on the blue LED and turns off all other LEDs.

Table 4: Single register control word

	Flash/Solid	Not Used	Blue	Yellow	Red	Green	Not Used									
Bit Position	15	14	13	12	11	10	9	8	7	6	5	4	3	2	1	0
	1	0	1	0	0	0	0	0	0	0	0	0	0	0	0	0
Decimal: 40960 (Hex: A000)																

Pick mode—When a green pick request is sent via single register control, touching the capacitive touch button changes the K70 color to yellow latched. Single register control is used to turn the K70 back off. For example, write a value of 1024 to Register 14 to enable (green light on). The yellow light turns on to acknowledge locally (I/O 6, Output Feedback, changes to 4096). Write 1023 (or 0) to reset to the off state. Banner Engineering recommends setting the Touch Feedback Control to No Feedback when using Pick mode.

Table 5: Pick mode control word

	Flash/Solid	Not Used	Blue	Yellow	Red	Green	Not Used									
Bit Position	15	14	13	12	11	10	9	8	7	6	5	4	3	2	1	0
	0	0	0	0	0	1	0	0	0	0	0	0	0	0	0	0
Decimal: 1024 (Hex: 400)																

Specifications

Supply Voltage

3.6 V DC from an internal battery

Supply Protection Circuitry

Protected against transient voltages

Operating Conditions

-40 °C to +50 °C (-40 °F to +122 °F)
95% at +50 °C maximum relative humidity (non-condensing)

Environmental Rating

IEC IP65

Vibration and Mechanical Shock

Vibration: 10 Hz to 55 Hz, 0.5 mm peak-to-peak amplitude per IEC 60068-2-6
Shock: 15G 11 ms duration, half sine wave per IEC 60068-2-27

Construction

Polycarbonate

Mounting

1/4-inch NPT base port for mounted applications
M30 x 1.5 threaded base, maximum torque 4.5 N-m (40 inch-lbf); mounting nut included

Radio Range[¶]

900 MHz, 1 Watt: Up to 3.2 km (2 miles) with line of sight (internal antenna)
2.4 GHz, 65 mW: Up to 1000 m (3280 ft) with line of sight (internal antenna)

900 MHz Compliance (1 Watt)

FCC ID UE3RM1809: FCC Part 15, Subpart C, 15.247
IC: 7044A-RM1809
IFT: RCPBARM13-2283

2.4 GHz Compliance

FCC ID UE300DX80-2400: FCC Part 15, Subpart C, 15.247
Radio Equipment Directive (RED) 2014/53/EU
IC: 7044A-DX8024

Indicator Response Time

Instant feedback indicator response triggered by capacitive touch button

Indicators

Green, Red, Yellow, Blue, White, cyan, and magenta LEDs are independently selected

Certifications



(CE approval only applies to 2.4 GHz models)



(NOM approval only applies to 900 MHz models)

Antenna Minimum Separation Distance

900 MHz, 150 mW and 250 mW: 2 m (6 ft)
900 MHz, 1 Watt: 4.57 m (15 ft)
2.4 GHz, 65 mW: 0.3 m (1 ft)

Radiated Immunity HF

10 V/m (EN 61000-4-3)

Spread Spectrum Technology

FHSS (Frequency Hopping Spread Spectrum)

Link Timeout (Performance)

Gateway: Configurable via User Configuration Software
Node: Defined by Gateway

Battery Life

Figure 3. 900 MHz radios

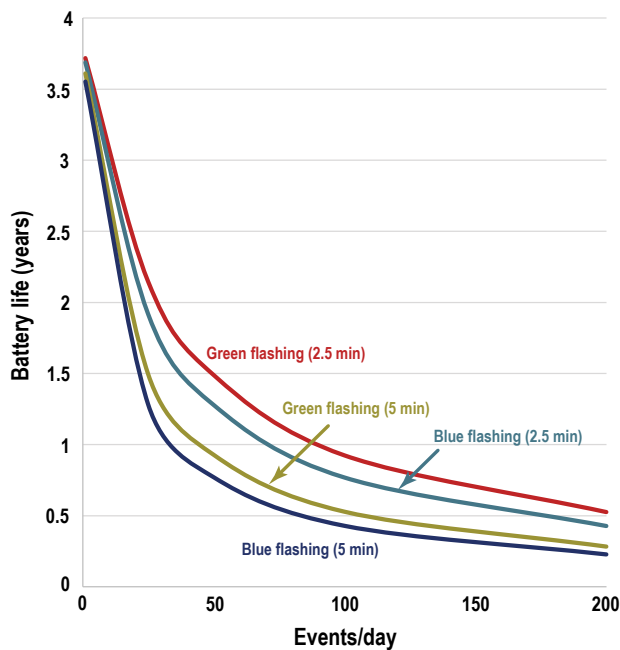
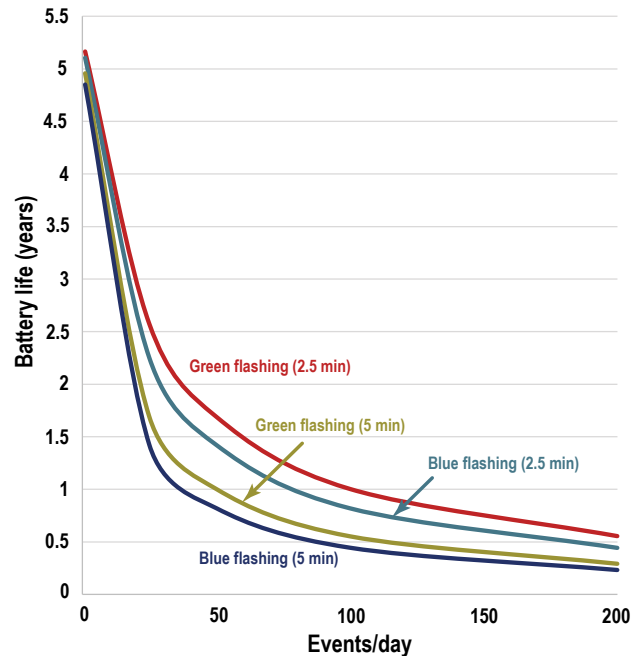

Figure 4. 2.4 GHz radios



An event is defined as on for the specified time (2.5 minutes or 5 minutes) and then off for that same time interval. For example, one event is when the light is on for 5 minutes, then off for 5 minutes.

[¶] Range depends on the environment and decreases significantly without line of sight. Always verify your wireless network's range by performing a Site Survey.

Dimensions

All measurements are listed in millimeters [inches], unless noted otherwise.

Figure 5. Dimensions

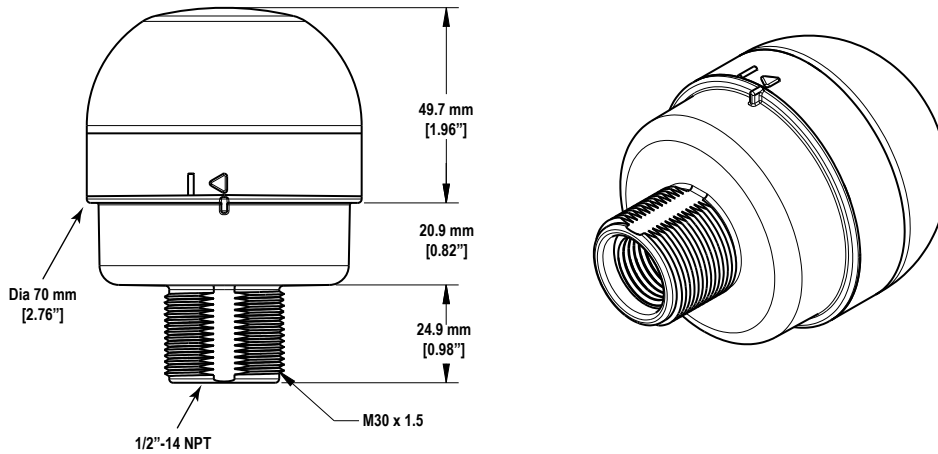

Accessories

Brackets

All measurements are listed in millimeters, unless noted otherwise.

LMB30LP

- Low profile
- 30 mm mounting hole
- 300 series stainless steel

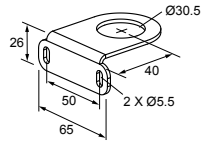

SMB30A

- Right-angle bracket with curved slot for versatile orientation
- Clearance for M6 (¼ in) hardware
- Mounting hole for 30 mm sensor
- 12-ga. stainless steel

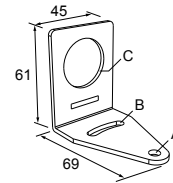

Hole center spacing: A to B=40
Hole size: A=ø 6.3, B= 27.1 x 6.3, C=ø 30.5

SMB30MM

- 12-ga. stainless steel bracket with curved mounting slots for versatile orientation
- Clearance for M6 (¼ in) hardware
- Mounting hole for 30 mm sensor

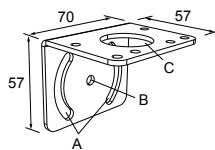

Hole center spacing: A = 51, A to B = 25.4
Hole size: A = 42.6 x 7, B = ø 6.4, C = ø 30.1

SMBAMS30P

- Flat SMBAMS series bracket
- 30 mm hole for mounting sensors
- Articulation slots for 90°+ rotation
- 12-ga. 300 series stainless steel

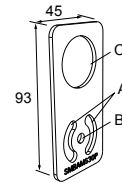

Hole center spacing: A=26.0, A to B=13.0
Hole size: A=26.8 x 7.0, B=ø 6.5, C=ø 31.0

SSA-MBK-EEC1

- Single 30 mm hole
- 8 gauge steel, black finish (powder coat)
- Front surface for customer applied labels

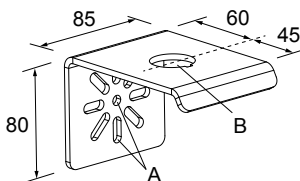

Hole size: A = ø 7, B = ø 30

Warnings

Exporting Sure Cross® Radios. It is our intent to fully comply with all national and regional regulations regarding radio frequency emissions. **Customers who want to re-export this product to a country other than that to which it was sold must ensure the device is approved in the destination country.** The Sure Cross wireless products were certified for use in these countries using the antenna that ships with the product. When using other antennas, verify you are not exceeding the transmit power levels allowed by local governing agencies. This device has been designed to operate with the antennas listed on Banner Engineering's website and having a maximum gain of 9 dBm. Antennas not included in this list or having a gain greater than 9 dBm are strictly prohibited for use with this device. The required antenna impedance is 50 ohms. To reduce potential radio interference to other users, the antenna type and its gain should be so chosen such that the equivalent isotropically radiated power (EIRP) is not more than that permitted for successful communication. Consult with Banner Engineering Corp. if the destination country is not on this list.



Important: Please download the complete K70 Wireless Battery-Powered Touch Button technical documentation, available in multiple languages, from www.bannerengineering.com for details on the proper use, applications, Warnings, and installation instructions of this device.



Important: Por favor descargue desde www.bannerengineering.com toda la documentación técnica de los K70 Wireless Battery-Powered Touch Button, disponibles en múltiples idiomas, para detalles del uso adecuado, aplicaciones, advertencias, y las instrucciones de instalación de estos dispositivos.



Important: Veuillez télécharger la documentation technique complète des K70 Wireless Battery-Powered Touch Button sur notre site www.bannerengineering.com pour les détails sur leur utilisation correcte, les applications, les notes de sécurité et les instructions de montage.



WARNING:

- **Do not use this device for personnel protection**
- Using this device for personnel protection could result in serious injury or death.
- This device does not include the self-checking redundant circuitry necessary to allow its use in personnel safety applications. A device failure or malfunction can cause either an energized (on) or de-energized (off) output condition.



Important:

- **Electrostatic discharge (ESD) sensitive device**
- ESD can damage the device. Damage from inappropriate handling is not covered by warranty.
- Use proper handling procedures to prevent ESD damage. Proper handling procedures include leaving devices in their anti-static packaging until ready for use; wearing anti-static wrist straps; and assembling units on a grounded, static-dissipative surface.

Banner Engineering Corp. Limited Warranty

Banner Engineering Corp. warrants its products to be free from defects in material and workmanship for one year following the date of shipment. Banner Engineering Corp. will repair or replace, free of charge, any product of its manufacture which, at the time it is returned to the factory, is found to have been defective during the warranty period. This warranty does not cover damage or liability for misuse, abuse, or the improper application or installation of the Banner product.

THIS LIMITED WARRANTY IS EXCLUSIVE AND IN LIEU OF ALL OTHER WARRANTIES WHETHER EXPRESS OR IMPLIED (INCLUDING, WITHOUT LIMITATION, ANY WARRANTY OF MERCHANTABILITY OR FITNESS FOR A PARTICULAR PURPOSE), AND WHETHER ARISING UNDER COURSE OF PERFORMANCE, COURSE OF DEALING OR TRADE USAGE.

This Warranty is exclusive and limited to repair or, at the discretion of Banner Engineering Corp., replacement. **IN NO EVENT SHALL BANNER ENGINEERING CORP. BE LIABLE TO BUYER OR ANY OTHER PERSON OR ENTITY FOR ANY EXTRA COSTS, EXPENSES, LOSSES, LOSS OF PROFITS, OR ANY INCIDENTAL, CONSEQUENTIAL OR SPECIAL DAMAGES RESULTING FROM ANY PRODUCT DEFECT OR FROM THE USE OR INABILITY TO USE THE PRODUCT, WHETHER ARISING IN CONTRACT OR WARRANTY, STATUTE, TORT, STRICT LIABILITY, NEGLIGENCE, OR OTHERWISE.**

Banner Engineering Corp. reserves the right to change, modify or improve the design of the product without assuming any obligations or liabilities relating to any product previously manufactured by Banner Engineering Corp. Any misuse, abuse, or improper application or installation of this product or use of the product for personal protection applications when the product is identified as not intended for such purposes will void the product warranty. Any modifications to this product without prior express approval by Banner Engineering Corp will void the product warranties. All specifications published in this document are subject to change; Banner reserves the right to modify product specifications or update documentation at any time. Specifications and product information in English supersede that which is provided in any other language. For the most recent version of any documentation, refer to: www.bannerengineering.com.

For patent information, see www.bannerengineering.com/patents.

Notas Adicionales

Información México: La operación de este equipo está sujeta a las siguientes dos condiciones: 1) es posible que este equipo o dispositivo no cause interferencia perjudicial y 2) este equipo debe aceptar cualquier interferencia, incluyendo la que pueda causar su operación no deseada.

Banner es una marca registrada de Banner Engineering Corp. y podrán ser utilizadas de manera indistinta para referirse al fabricante. "Este equipo ha sido diseñado para operar con las antenas tipo Omnidireccional para una ganancia máxima de antena de 6 dBd y Yagi para una ganancia máxima de antena 10 dBd que en seguida se enlistan. También se incluyen aquellas con aprobación ATEX tipo Omnidireccional siempre que no excedan una ganancia máxima de antena de 6dBd. El uso con este equipo de antenas no incluidas en esta lista o que tengan una ganancia mayor que 6 dBd en tipo omnidireccional y 10 dBd en tipo Yagi, quedan prohibidas. La impedancia requerida de la antena es de 50 ohms."

Antenas SMA	Modelo	Antenas Tipo-N	Modelo
Antena, Omni 902-928 MHz, 2 dBd, junta de caucho, RP-SMA Macho	BWA-902-C	Antena, Omni 902-928 MHz, 6 dBd, fibra de vidrio, 1800mm, N Hembra	BWA-906-A
Antena, Omni 902-928 MHz, 5 dBd, junta de caucho, RP-SMA Macho	BWA-905-C	Antena, Yagi, 900 MHz, 10 dBd, N Hembra	BWA-9Y10-A

Mexican Importer

Banner Engineering de México, S. de R.L. de C.V.
David Alfaro Siqueiros 103 Piso 2 Valle oriente
San Pedro Garza García Nuevo León, C. P. 66269
81 8363.2714