

CSD25402Q3A –20 V P-Channel NexFET™ Power MOSFET

1 Features

- Ultra-Low Q_g and Q_{gd}
- Low Thermal Resistance
- Low $R_{DS(on)}$
- Pb and Halogen Free
- RoHS Compliant
- SON 3.3 mm × 3.3 mm Plastic Package

2 Applications

- DC-DC Converters
- Battery Management
- Load Switch
- Battery Protection

3 Description

This –20-V, 7.7-mΩ NexFET™ power MOSFET is designed to minimize losses in power conversion load management applications with a SON 3.3 mm × 3.3 mm package that offers an excellent thermal performance for the size of the device.

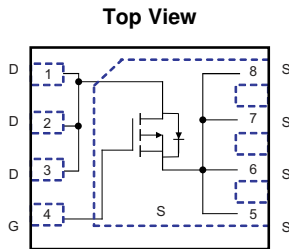

Product Summary

$T_A = 25^\circ\text{C}$		TYPICAL VALUE	UNIT
V_{DS}	Drain-to-source voltage	–20	V
Q_g	Gate charge total (–4.5 V)	7.5	nC
Q_{gd}	Gate charge gate to drain	1.1	nC
$R_{DS(on)}$	Drain-to-source on resistance	$V_{GS} = -1.8\text{ V}$	74 mΩ
		$V_{GS} = -2.5\text{ V}$	13.3 mΩ
		$V_{GS} = -4.5\text{ V}$	7.7 mΩ
V_{th}	Threshold voltage	–0.9	V

Ordering Information⁽¹⁾

DEVICE	QTY	MEDIA	PACKAGE	SHIP
CSD25402Q3A	2500	13-Inch Reel	SON 3.3 mm × 3.3 mm Plastic Package	Tape and Reel
CSD25402Q3AT	250	7-Inch Reel		

(1) For all available packages, see the orderable addendum at the end of the data sheet.

Absolute Maximum Ratings

$T_A = 25^\circ\text{C}$		VALUE	UNIT
V_{DS}	Drain-to-source voltage	–20	V
V_{GS}	Gate-to-source voltage	+12 or –12	V
I_D	Continuous drain current, $T_C = 25^\circ\text{C}$	–76	A
	Continuous drain current (package limit)	–35	A
	Continuous drain current ⁽¹⁾	–15	A
I_{DM}	Pulsed drain current ⁽²⁾	–148	A
P_D	Power dissipation ⁽¹⁾	2.8	W
	Power dissipation, $T_C = 25^\circ\text{C}$	69	
T_J	Operating junction temperature	–55 to 150	$^\circ\text{C}$
T_{stg}	Storage temperature	–55 to 150	$^\circ\text{C}$

(1) Typical $R_{\theta JA} = 45^\circ\text{C/W}$ on 1 inch² Cu (2 oz.) on 0.060 inch thick FR4 PCB.

(2) Max $R_{\theta JC} = 2.3^\circ\text{C/W}$, pulse duration $\leq 100\ \mu\text{s}$, duty cycle $\leq 1\%$

$R_{DS(on)}$ vs V_{GS}

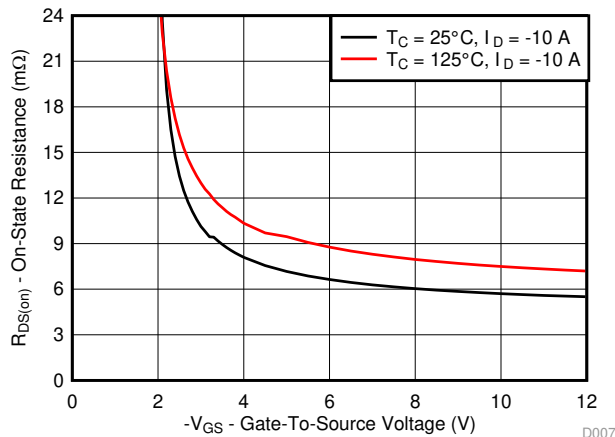

Gate Charge

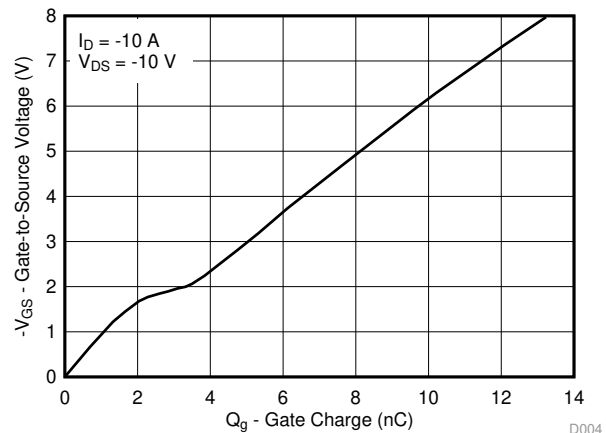

Table of Contents

1 Features	1	6.1 Community Resources.....	7
2 Applications	1	6.2 Trademarks	7
3 Description	1	6.3 Electrostatic Discharge Caution	7
4 Revision History	2	6.4 Glossary	7
5 Specifications	3	7 Mechanical, Packaging, and Orderable Information	8
5.1 Electrical Characteristics.....	3	7.1 Q3A Package Dimensions	8
5.2 Thermal Information	3	7.2 Q3A Recommended PCB Pattern	9
5.3 Typical MOSFET Characteristics.....	4	7.3 Q3A Recommended Stencil Pattern	9
6 Device and Documentation Support	7	7.4 Q3A Tape and Reel Information	10

4 Revision History

NOTE: Page numbers for previous revisions may differ from page numbers in the current version.

Changes from Revision A (July 2015) to Revision B	Page
• Updated Package Dimensions drawing.....	8
• Updated PCB drawing.	9
• Updated Stencil Pattern drawing.	9

Changes from Original (December 2013) to Revision A	Page
• Added part number to title.	1
• Added 7-inch reel to <i>Ordering Information</i> table	1
• Lowered typical $R_{\theta JA}$ from 55 to 45°C/W in <i>Absolute Maximum Ratings Table</i> footnote.	1
• Increased max pulsed current to –148 A.	1
• Added line for max power dissipation with the case temperature held to 25°C in <i>Absolute Maximum Ratings Table</i>	1
• Updated pulsed current conditions.	1
• Updated Figure 1 to a normalized $R_{\theta JC}$ curve.	4
• Updated SOA in Figure 10	6

5 Specifications

5.1 Electrical Characteristics

(T_A = 25°C unless otherwise stated)

PARAMETER		TEST CONDITIONS	MIN	TYP	MAX	UNIT
STATIC CHARACTERISTICS						
B _V DSS	Drain-to-source voltage	V _{GS} = 0 V, I _D = -250 μA	-20			V
I _{DSS}	Drain-to-source leakage current	V _{GS} = 0 V, V _{DS} = -16 V			-1	μA
I _{GSS}	Gate-to-source leakage current	V _{DS} = 0 V, V _{GS} = ±12 V			-100	nA
V _{GS(th)}	Gate-to-source threshold voltage	V _{DS} = V _{GS} , I _D = -250 μA	-0.65	-0.90	-1.15	V
R _{DS(on)}	Drain-to-source on resistance	V _{GS} = -1.8 V, I _D = -1 A		74	300	mΩ
		V _{GS} = -2.5 V, I _D = -10 A		13.3	15.9	mΩ
		V _{GS} = -4.5 V, I _D = -10 A		7.7	8.9	mΩ
g _{fs}	Transconductance	V _{DS} = -10 V, I _D = -10 A		59		S
DYNAMIC CHARACTERISTICS						
C _{ISS}	Input capacitance	V _{GS} = 0 V, V _{DS} = -10 V, f = 1 MHz		1380	1790	pF
C _{OSS}	Output capacitance			763	992	pF
C _{RSS}	Reverse transfer capacitance			39	51	pF
R _G	Series gate resistance			3.7	7.4	Ω
Q _g	Gate charge total (-4.5 V)	V _{DS} = -10 V, I _D = -10 A		7.5	9.7	nC
Q _{gd}	Gate charge gate to drain			1.1		nC
Q _{gs}	Gate charge gate to source			2.4		nC
Q _{g(th)}	Gate charge at V _{th}			1.0		nC
Q _{OSS}	Output charge		V _{DS} = -10 V, V _{GS} = 0 V		7.6	
t _{d(on)}	Turn on delay time	V _{DS} = -10 V, V _{GS} = -4.5 V, I _D = -10 A, R _G = 5 Ω		10		ns
t _r	Rise time			7		ns
t _{d(off)}	Turn off delay time			25		ns
t _f	Fall time			12		ns
DIODE CHARACTERISTICS						
V _{SD}	Diode forward voltage	I _S = -10 A, V _{GS} = 0 V		-0.8	-1	V
Q _{rr}	Reverse recovery charge	V _{DS} = -8.5 V, I _F = -10 A, di/dt = 200 A/μs		10.3		nC
t _{rr}	Reverse recovery time			21		ns

5.2 Thermal Information

(T_A = 25°C unless otherwise stated)

THERMAL METRIC		MIN	TYP	MAX	UNIT
R _{θJC}	Junction-to-case thermal resistance ⁽¹⁾			2.3	°C/W
R _{θJA}	Junction-to-ambient thermal resistance ⁽¹⁾⁽²⁾			55	°C/W

- (1) R_{θJC} is determined with the device mounted on a 1 inch² (6.45 cm²), 2 oz. (0.071 mm thick) Cu pad on a 1.5 inch × 1.5 inch (3.81 cm × 3.81 cm), 0.06 inch (1.52 mm) thick FR4 PCB. R_{θJC} is specified by design, whereas R_{θJA} is determined by the user's board design.
- (2) Device mounted on FR4 material with 1 inch² (6.45 cm²), 2 oz. (0.071 mm thick) Cu.

CSD25402Q3A

SLPS454B – DECEMBER 2013 – REVISED JANUARY 2016

www.ti.com

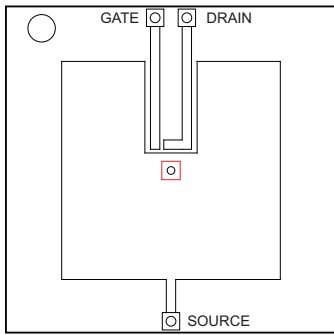

M0137-01

Max $R_{\theta JA} = 55^{\circ}\text{C/W}$
when mounted on
1 inch² of 2 oz. Cu.

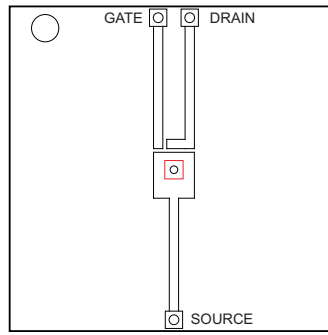

M0137-02

Max $R_{\theta JA} = 175^{\circ}\text{C/W}$
when mounted on
minimum pad area of
2 oz. Cu.

5.3 Typical MOSFET Characteristics

($T_A = 25^{\circ}\text{C}$ unless otherwise stated)

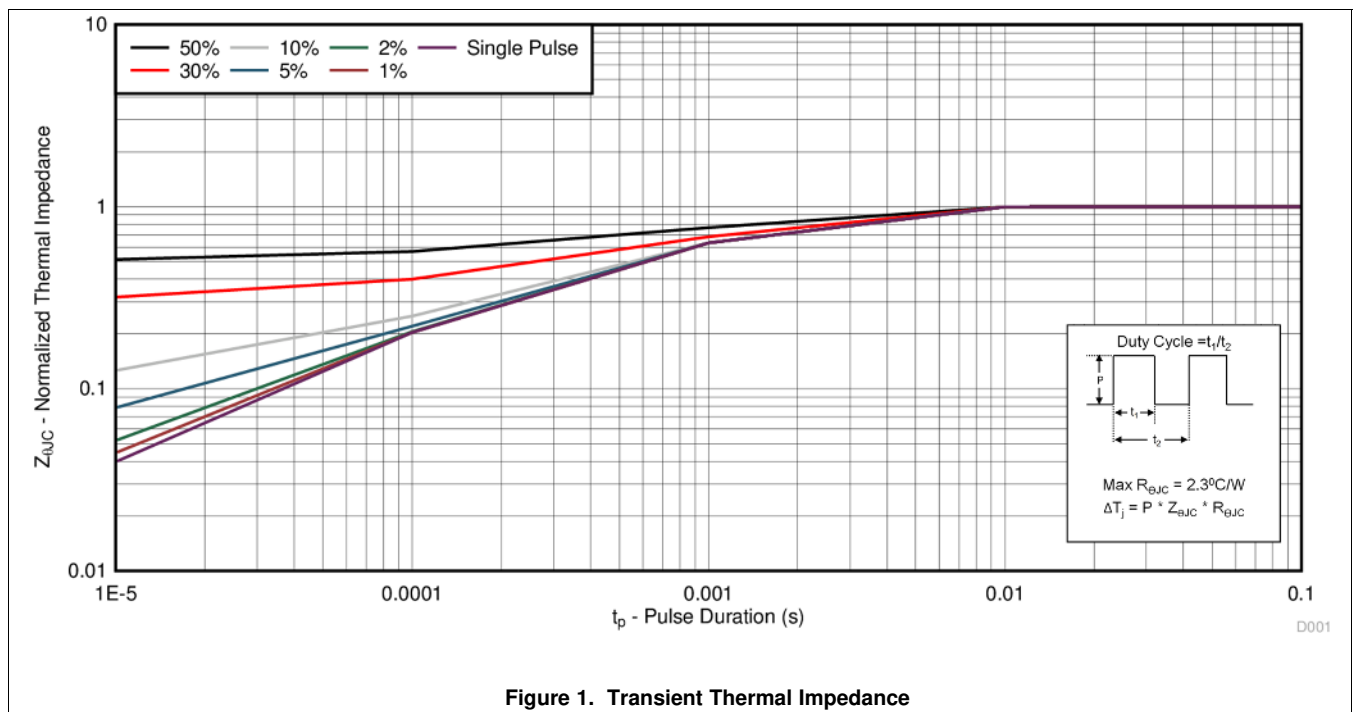

Figure 1. Transient Thermal Impedance

Typical MOSFET Characteristics (continued)

($T_A = 25^\circ\text{C}$ unless otherwise stated)

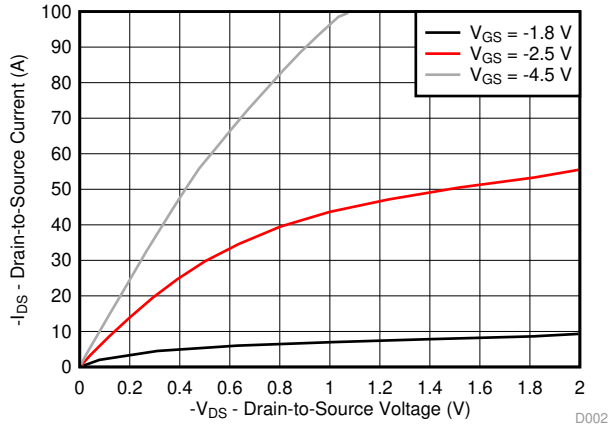

Figure 2. Saturation Characteristics

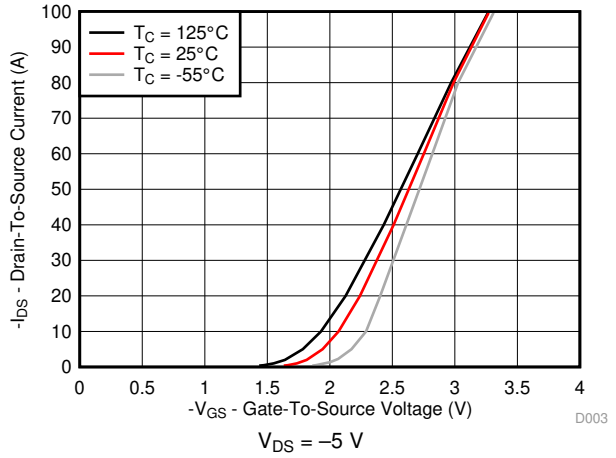

Figure 3. Transfer Characteristics

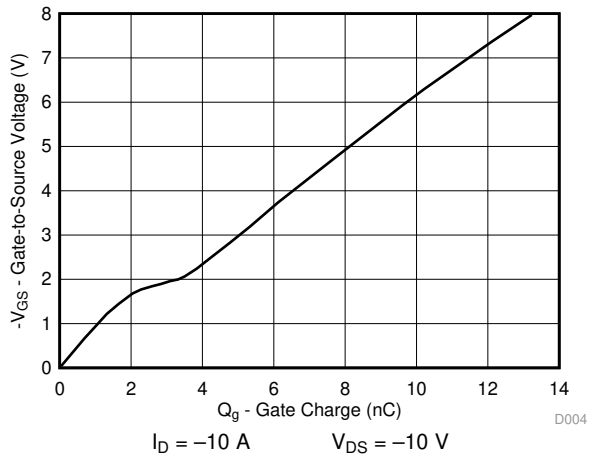

Figure 4. Gate Charge

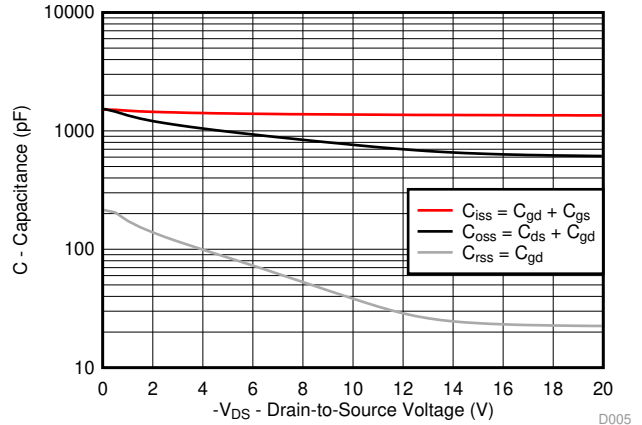

Figure 5. Capacitance

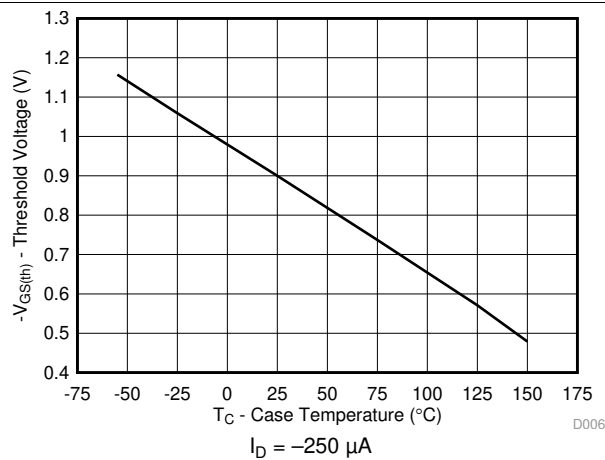

Figure 6. Threshold Voltage vs Temperature

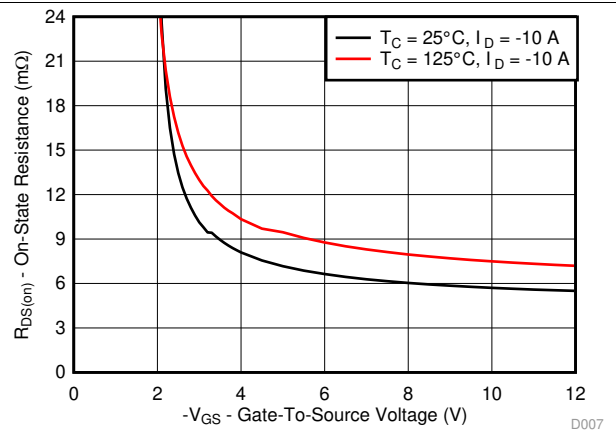

Figure 7. On-State Resistance vs Gate-to-Source Voltage

Typical MOSFET Characteristics (continued)

($T_A = 25^\circ\text{C}$ unless otherwise stated)

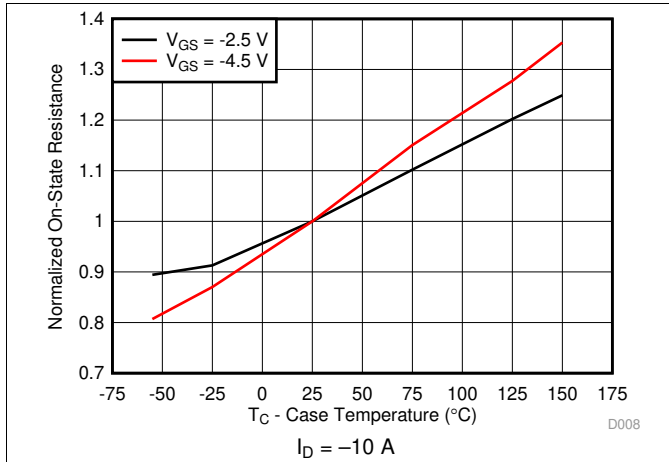

Figure 8. Normalized On-State Resistance vs Temperature

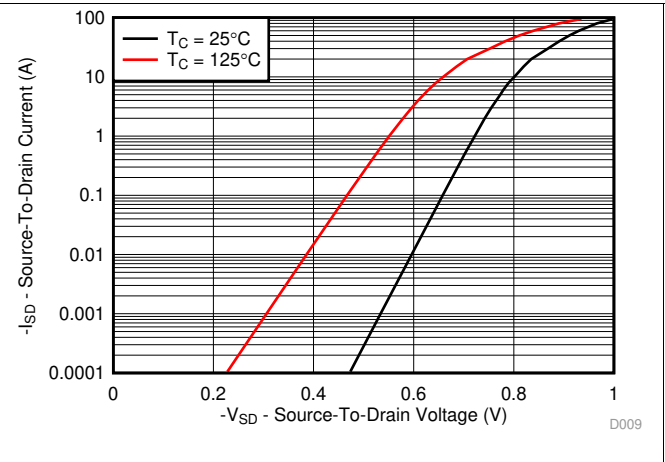

Figure 9. Typical Diode Forward Voltage

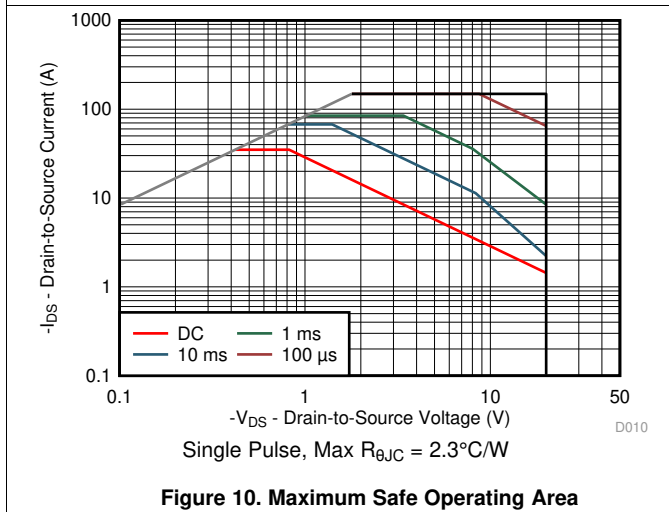

Figure 10. Maximum Safe Operating Area

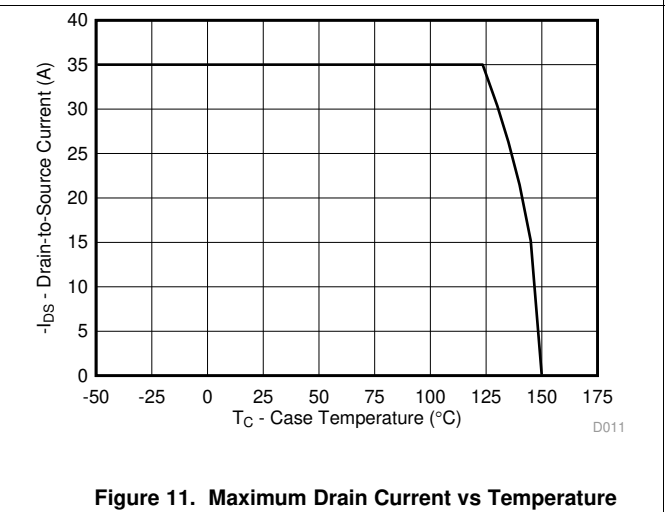

Figure 11. Maximum Drain Current vs Temperature

6 Device and Documentation Support

6.1 Community Resources

The following links connect to TI community resources. Linked contents are provided "AS IS" by the respective contributors. They do not constitute TI specifications and do not necessarily reflect TI's views; see TI's [Terms of Use](#).

TI E2E™ Online Community *TI's Engineer-to-Engineer (E2E) Community*. Created to foster collaboration among engineers. At e2e.ti.com, you can ask questions, share knowledge, explore ideas and help solve problems with fellow engineers.

Design Support *TI's Design Support* Quickly find helpful E2E forums along with design support tools and contact information for technical support.

6.2 Trademarks

NexFET, E2E are trademarks of Texas Instruments.
All other trademarks are the property of their respective owners.

6.3 Electrostatic Discharge Caution



These devices have limited built-in ESD protection. The leads should be shorted together or the device placed in conductive foam during storage or handling to prevent electrostatic damage to the MOS gates.

6.4 Glossary

[SLYZ022](#) — *TI Glossary*.

This glossary lists and explains terms, acronyms, and definitions.

7 Mechanical, Packaging, and Orderable Information

The following pages include mechanical, packaging, and orderable information. This information is the most current data available for the designated devices. This data is subject to change without notice and revision of this document. For browser-based versions of this data sheet, refer to the left-hand navigation.

7.1 Q3A Package Dimensions

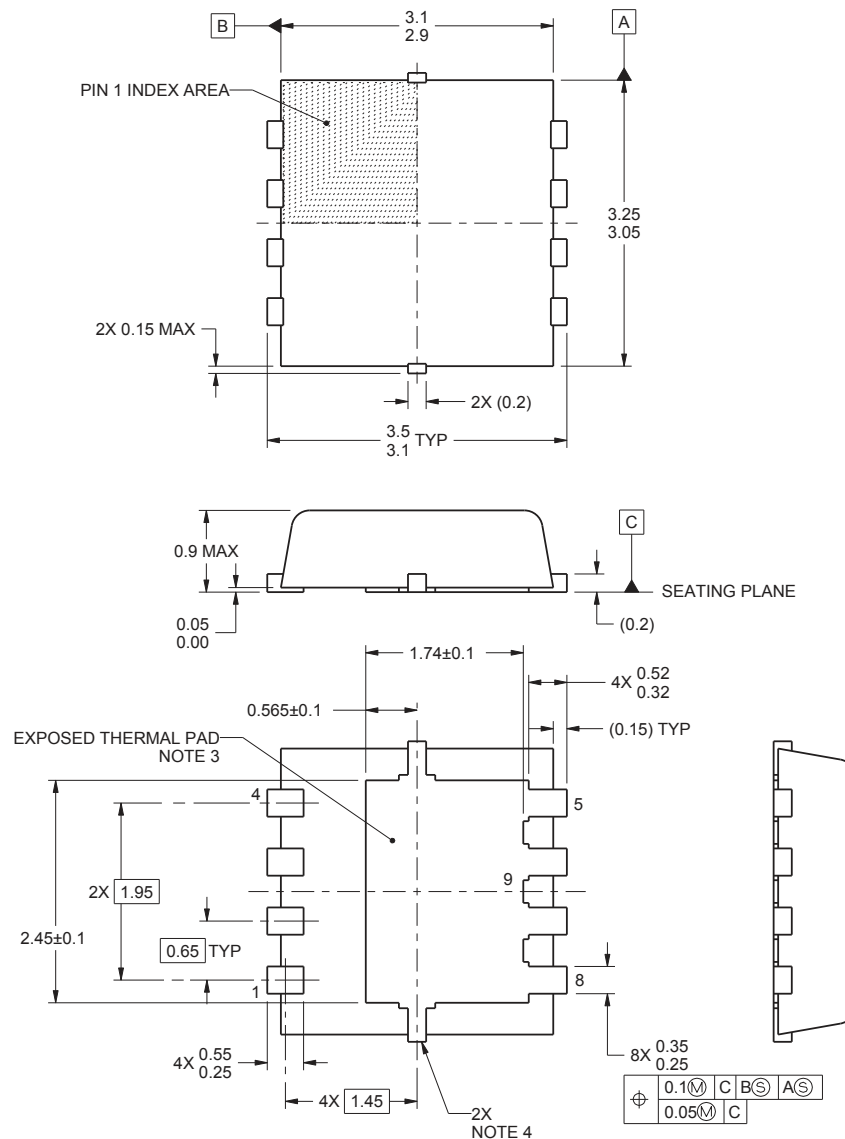

1. All linear dimensions are in millimeters. Any dimensions in parenthesis are for reference only. Dimensioning and tolerancing per ASME Y14.5M.
2. This drawing is subject to change without notice.
3. The package thermal pad must be soldered to the printed circuit board for thermal and mechanical performance.
4. Metalized features are supplier options and may not be on the package.
5. All dimensions do not include mold flash or protrusions.

7.2 Q3A Recommended PCB Pattern

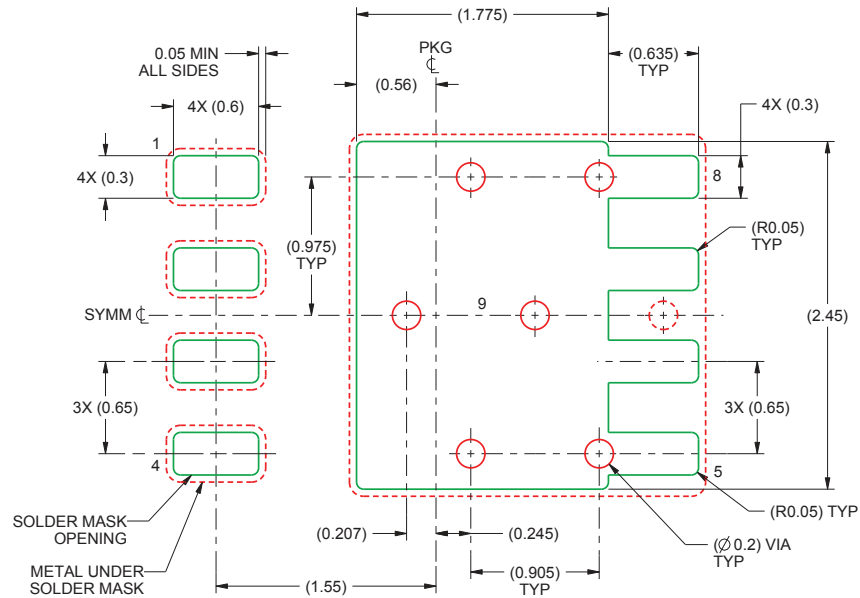

1. This package is designed to be soldered to a thermal pad on the board. For more information, see *QFN/SOP PCB Attachment* application report, [SLUA271](#).
2. Vias are optional depending on application, refer to device data sheet. If some or all are implemented, recommended via locations are shown.

For recommended circuit layout for PCB designs, see application note [SLPA005 – Reducing Ringing Through PCB Layout Techniques](#).

7.3 Q3A Recommended Stencil Pattern

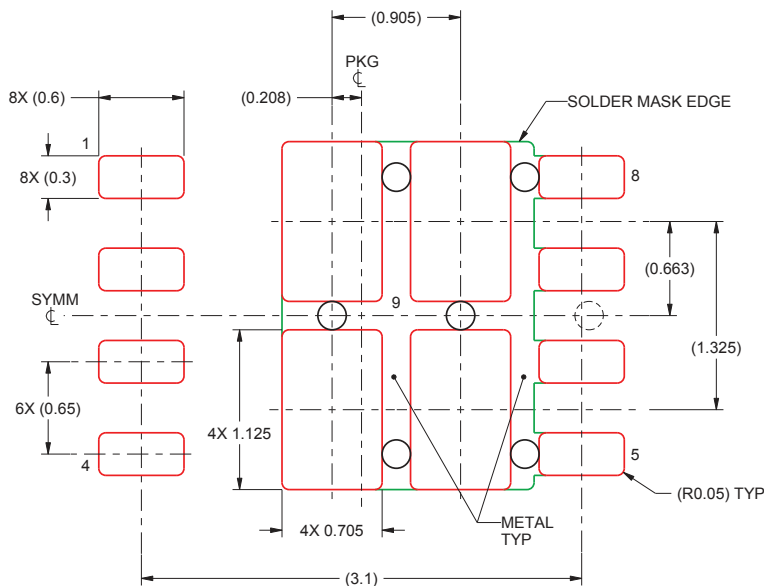

1. Laser cutting apertures with trapezoidal walls and rounded corners may offer better paste release. IPC-7525 may have alternate design recommendations.

7.4 Q3A Tape and Reel Information

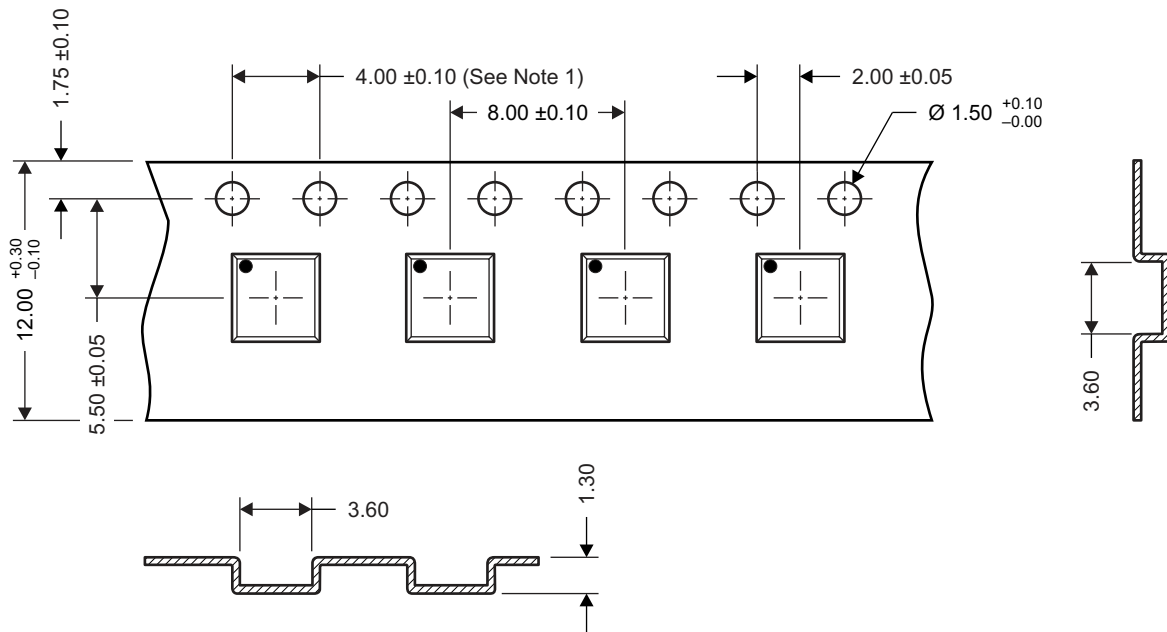

- Notes:
1. 10-sprocket hole-pitch cumulative tolerance ± 0.2
 2. Camber not to exceed 1 mm in 100 mm, noncumulative over 250 mm
 3. Material: black static-dissipative polystyrene
 4. All dimensions are in mm, unless otherwise specified
 5. Thickness: 0.30 ± 0.05 mm
 6. MSL1 260°C (IR and convection) PbF reflow compatible

M0144-01

PACKAGING INFORMATION

Orderable Device	Status (1)	Package Type	Package Drawing	Pins	Package Qty	Eco Plan (2)	Lead finish/ Ball material (6)	MSL Peak Temp (3)	Op Temp (°C)	Device Marking (4/5)	Samples
CSD25402Q3A	ACTIVE	VSONP	DNH	8	2500	RoHS & Green	SN	Level-1-260C-UNLIM	-55 to 150	25402	Samples
CSD25402Q3AT	ACTIVE	VSONP	DNH	8	250	RoHS & Green	SN	Level-1-260C-UNLIM	-55 to 150	25402	Samples

(1) The marketing status values are defined as follows:

ACTIVE: Product device recommended for new designs.

LIFEBUY: TI has announced that the device will be discontinued, and a lifetime-buy period is in effect.

NRND: Not recommended for new designs. Device is in production to support existing customers, but TI does not recommend using this part in a new design.

PREVIEW: Device has been announced but is not in production. Samples may or may not be available.

OBsolete: TI has discontinued the production of the device.

(2) **RoHS:** TI defines "RoHS" to mean semiconductor products that are compliant with the current EU RoHS requirements for all 10 RoHS substances, including the requirement that RoHS substance do not exceed 0.1% by weight in homogeneous materials. Where designed to be soldered at high temperatures, "RoHS" products are suitable for use in specified lead-free processes. TI may reference these types of products as "Pb-Free".

RoHS Exempt: TI defines "RoHS Exempt" to mean products that contain lead but are compliant with EU RoHS pursuant to a specific EU RoHS exemption.

Green: TI defines "Green" to mean the content of Chlorine (Cl) and Bromine (Br) based flame retardants meet JS709B low halogen requirements of <=1000ppm threshold. Antimony trioxide based flame retardants must also meet the <=1000ppm threshold requirement.

(3) MSL, Peak Temp. - The Moisture Sensitivity Level rating according to the JEDEC industry standard classifications, and peak solder temperature.

(4) There may be additional marking, which relates to the logo, the lot trace code information, or the environmental category on the device.

(5) Multiple Device Markings will be inside parentheses. Only one Device Marking contained in parentheses and separated by a "~" will appear on a device. If a line is indented then it is a continuation of the previous line and the two combined represent the entire Device Marking for that device.

(6) Lead finish/Ball material - Orderable Devices may have multiple material finish options. Finish options are separated by a vertical ruled line. Lead finish/Ball material values may wrap to two lines if the finish value exceeds the maximum column width.

Important Information and Disclaimer:The information provided on this page represents TI's knowledge and belief as of the date that it is provided. TI bases its knowledge and belief on information provided by third parties, and makes no representation or warranty as to the accuracy of such information. Efforts are underway to better integrate information from third parties. TI has taken and continues to take reasonable steps to provide representative and accurate information but may not have conducted destructive testing or chemical analysis on incoming materials and chemicals. TI and TI suppliers consider certain information to be proprietary, and thus CAS numbers and other limited information may not be available for release.

In no event shall TI's liability arising out of such information exceed the total purchase price of the TI part(s) at issue in this document sold by TI to Customer on an annual basis.

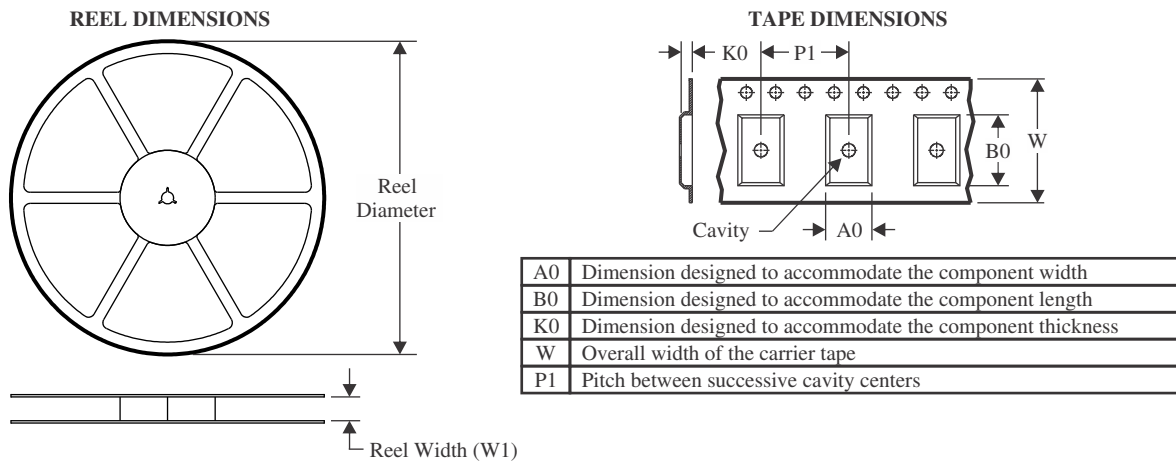
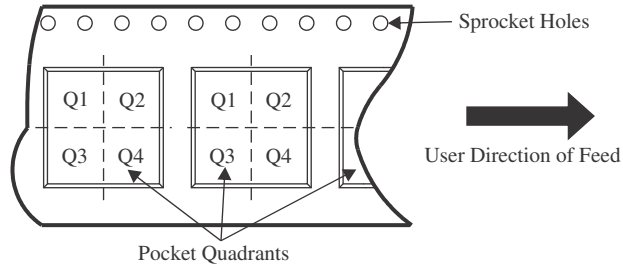
TAPE AND REEL INFORMATION

QUADRANT ASSIGNMENTS FOR PIN 1 ORIENTATION IN TAPE

*All dimensions are nominal

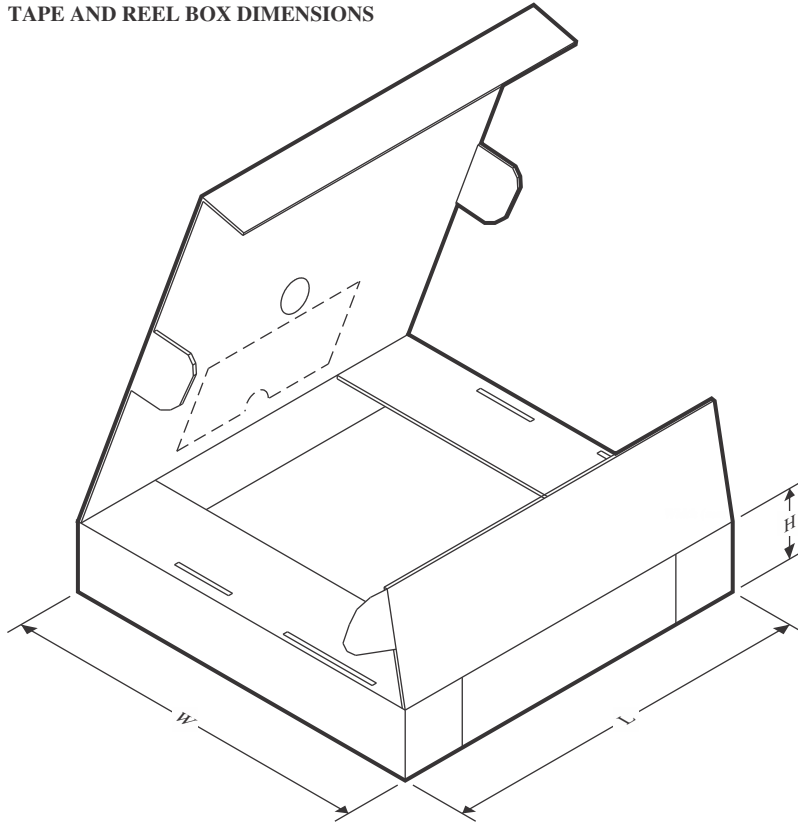
Device	Package Type	Package Drawing	Pins	SPQ	Reel Diameter (mm)	Reel Width W1 (mm)	A0 (mm)	B0 (mm)	K0 (mm)	P1 (mm)	W (mm)	Pin1 Quadrant
CSD25402Q3A	VSONP	DNH	8	2500	330.0	12.4	3.6	3.6	1.1	8.0	12.0	Q1
CSD25402Q3AT	VSONP	DNH	8	250	180.0	12.4	3.6	3.6	1.1	8.0	12.0	Q1

TAPE AND REEL BOX DIMENSIONS

*All dimensions are nominal

Device	Package Type	Package Drawing	Pins	SPQ	Length (mm)	Width (mm)	Height (mm)
CSD25402Q3A	VSONP	DNH	8	2500	340.0	340.0	38.0
CSD25402Q3AT	VSONP	DNH	8	250	190.0	190.0	30.0

PACKAGE OUTLINE

DNH0008A

VSONP - 0.9 mm max height

PLASTIC SMALL OUTLINE - NO LEAD

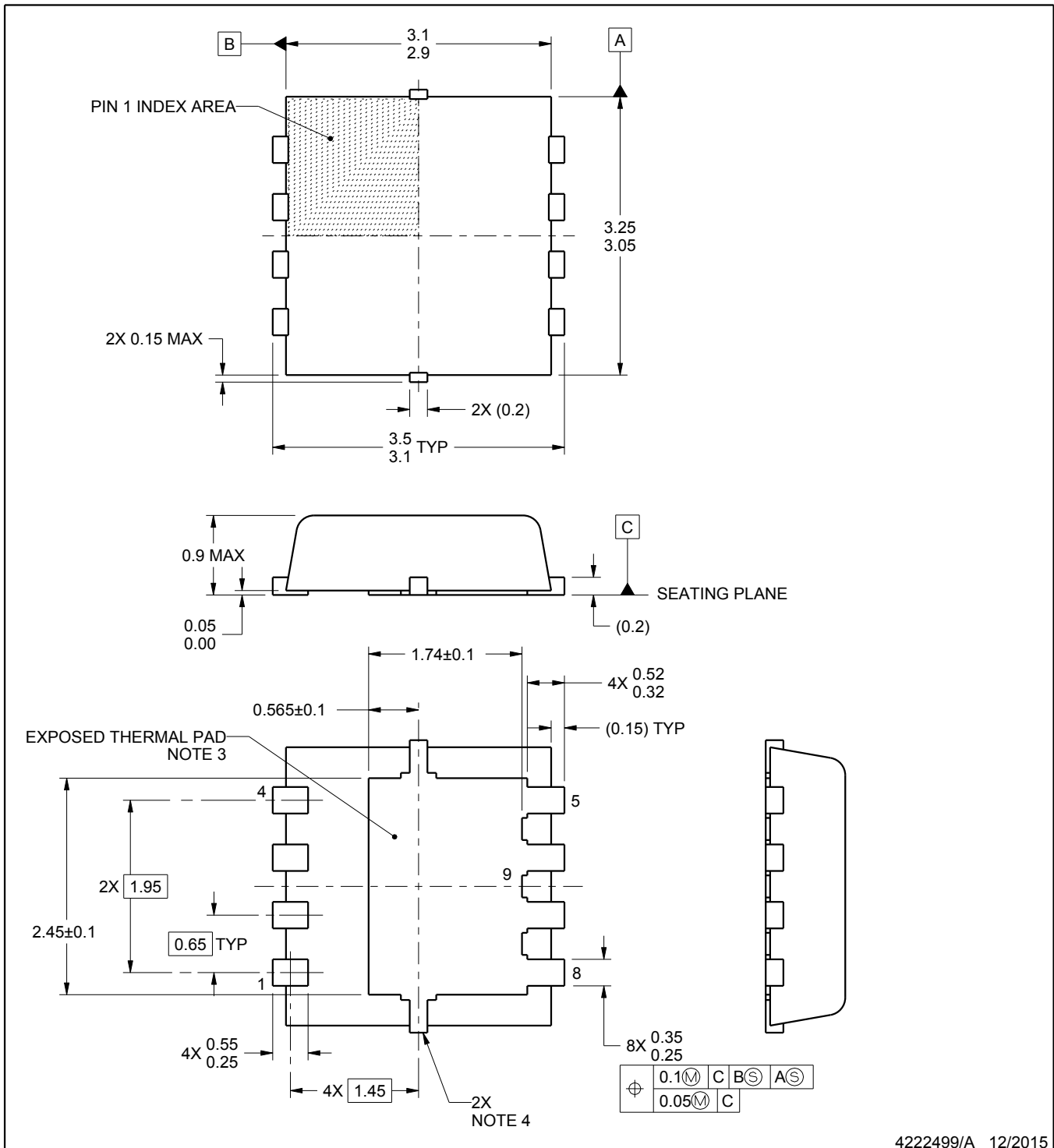

4222499/A 12/2015

NOTES:

1. All linear dimensions are in millimeters. Any dimensions in parenthesis are for reference only. Dimensioning and tolerancing per ASME Y14.5M.
2. This drawing is subject to change without notice.
3. The package thermal pad must be soldered to the printed circuit board for thermal and mechanical performance.
4. Metalized features are supplier options and may not be on the package.
5. All dimensions do not include mold flash or protrusions.

EXAMPLE BOARD LAYOUT

DNH0008A

VSONP - 0.9 mm max height

PLASTIC SMALL OUTLINE - NO LEAD

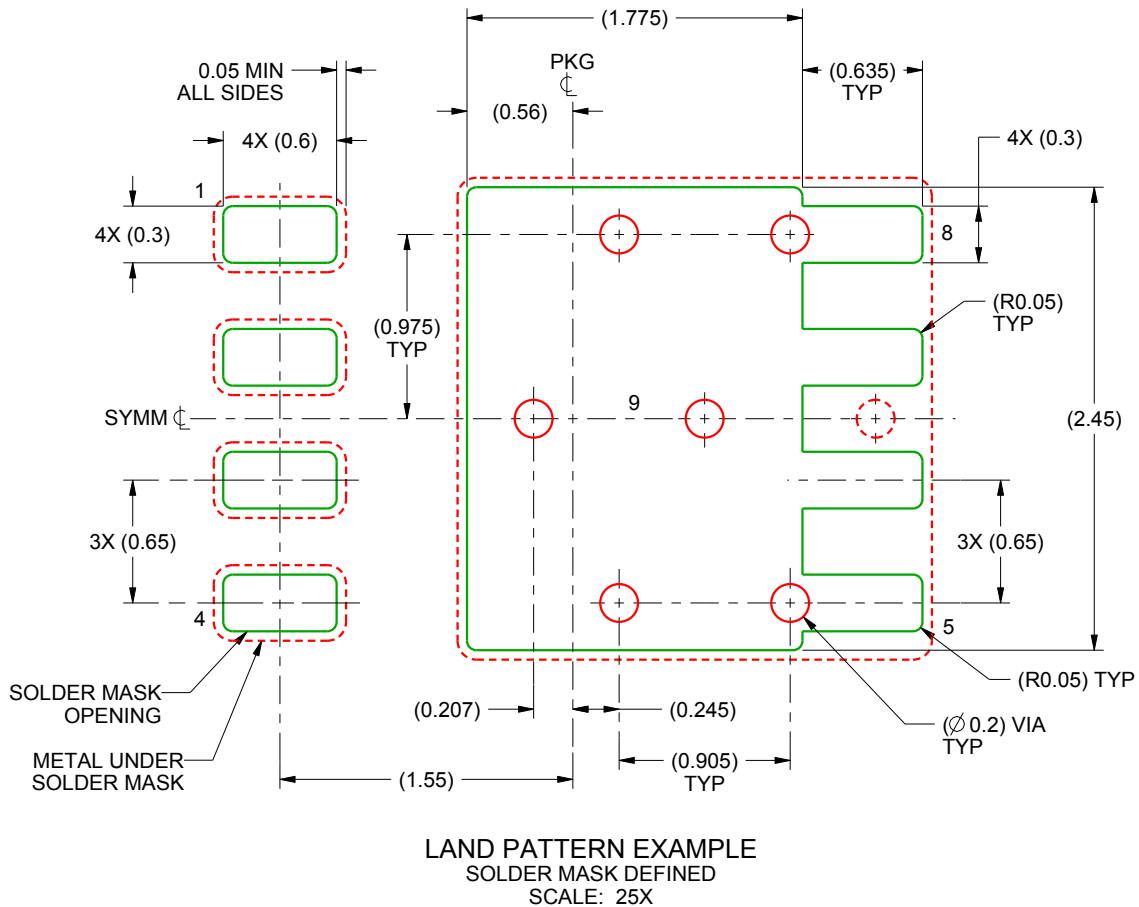

4222499/A 12/2015

NOTES: (continued)

6. This package is designed to be soldered to a thermal pad on the board. For more information, see Texas Instruments literature number SLUA271 (www.ti.com/lit/sluea271).
7. Vias are optional depending on application, refer to device data sheet. If some or all are implemented, recommended via locations are shown.

EXAMPLE STENCIL DESIGN

DNH0008A

VSONP - 0.9 mm max height

PLASTIC SMALL OUTLINE - NO LEAD

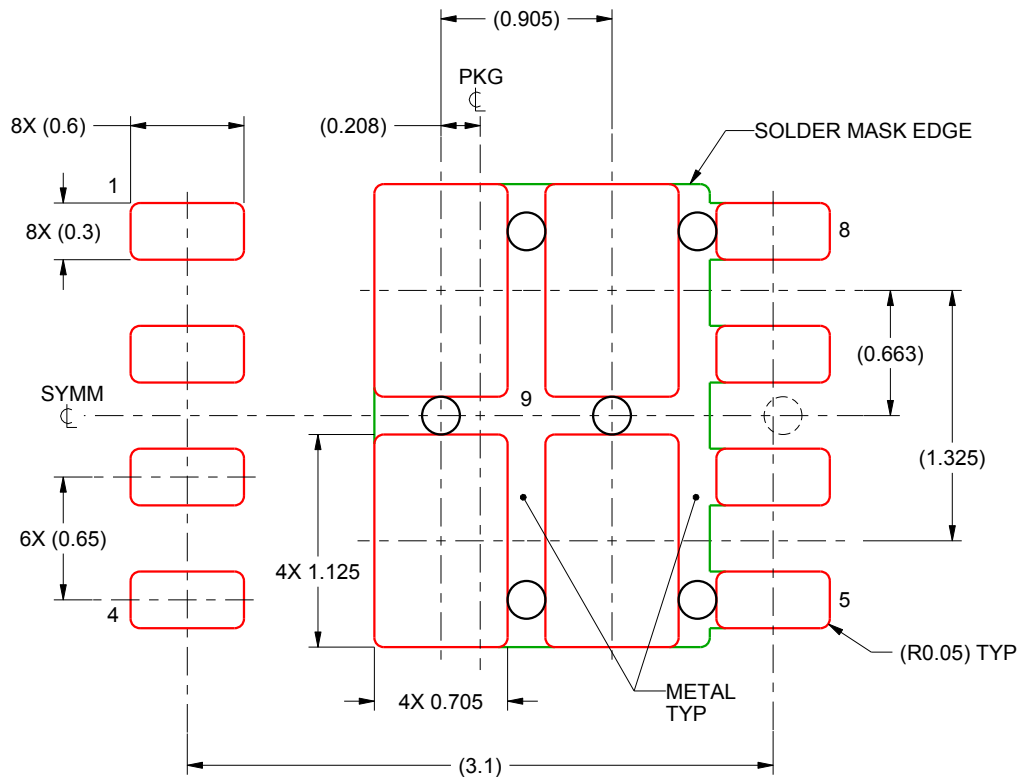

SOLDER PASTE EXAMPLE
BASED ON 0.125 mm THICK STENCIL

EXPOSED PAD 9:
76% PRINTED SOLDER COVERAGE BY AREA UNDER PACKAGE
SCALE: 25X

4222499/A 12/2015

NOTES: (continued)

8. Laser cutting apertures with trapezoidal walls and rounded corners may offer better paste release. IPC-7525 may have alternate design recommendations.

IMPORTANT NOTICE AND DISCLAIMER

TI PROVIDES TECHNICAL AND RELIABILITY DATA (INCLUDING DATA SHEETS), DESIGN RESOURCES (INCLUDING REFERENCE DESIGNS), APPLICATION OR OTHER DESIGN ADVICE, WEB TOOLS, SAFETY INFORMATION, AND OTHER RESOURCES "AS IS" AND WITH ALL FAULTS, AND DISCLAIMS ALL WARRANTIES, EXPRESS AND IMPLIED, INCLUDING WITHOUT LIMITATION ANY IMPLIED WARRANTIES OF MERCHANTABILITY, FITNESS FOR A PARTICULAR PURPOSE OR NON-INFRINGEMENT OF THIRD PARTY INTELLECTUAL PROPERTY RIGHTS.

These resources are intended for skilled developers designing with TI products. You are solely responsible for (1) selecting the appropriate TI products for your application, (2) designing, validating and testing your application, and (3) ensuring your application meets applicable standards, and any other safety, security, regulatory or other requirements.

These resources are subject to change without notice. TI grants you permission to use these resources only for development of an application that uses the TI products described in the resource. Other reproduction and display of these resources is prohibited. No license is granted to any other TI intellectual property right or to any third party intellectual property right. TI disclaims responsibility for, and you will fully indemnify TI and its representatives against, any claims, damages, costs, losses, and liabilities arising out of your use of these resources.

TI's products are provided subject to [TI's Terms of Sale](#) or other applicable terms available either on [ti.com](https://www.ti.com) or provided in conjunction with such TI products. TI's provision of these resources does not expand or otherwise alter TI's applicable warranties or warranty disclaimers for TI products.

TI objects to and rejects any additional or different terms you may have proposed.

Mailing Address: Texas Instruments, Post Office Box 655303, Dallas, Texas 75265
Copyright © 2023, Texas Instruments Incorporated