

CPDF12V0U-HF

RoHS Device
Halogen Free



Features

- Uni-directional ESD protection.
- Surface mount package.
- High component density.

Mechanical data

- Case: 1005/SOD-323F standard package, molded plastic.
- Terminals: Gold plated, solderable per MIL-STD-750, method 2026.
- Marking Code: Cathode band & E12
- Mounting position: Any.
- Weight: 0.006 grams (approx.).

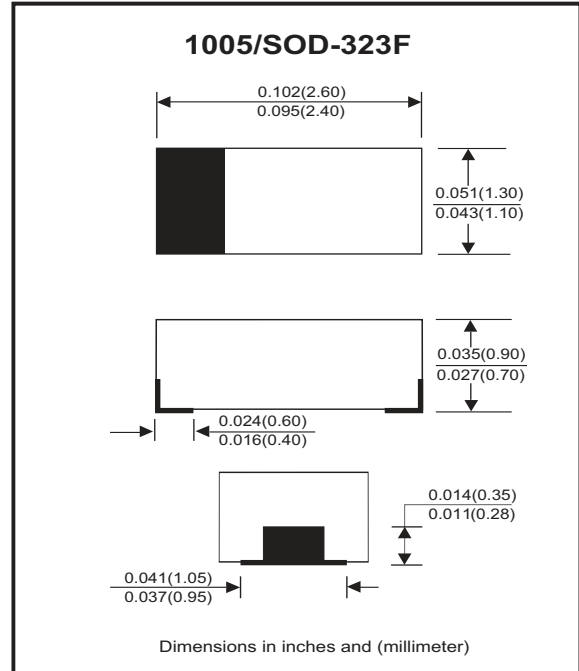

Circuit Diagram



Maximum Rating And Electrical Characteristics

(at $T_A=25^\circ\text{C}$ unless otherwise noted)

Parameter	Conditions	Symbol	Min	Typ	Max	Unit
Forward voltage	$I_F = 10\text{mA}$	V_F		0.8		V
Diode breakdown voltage	$I_R = 1\text{mA}$	V_{BD}	13.3	15.5	17.5	V
Leakage current	$V_R = 12\text{V}$	I_L		0.1	1.0	μA
Junction capacitance	$V_R = 0\text{V}, f = 1\text{MHz}$	C_T			60	pF
ESD capability	IEC 61000-4-2(air) IEC 61000-4-2(contact)	ESD			30	kV
Clamping voltage	$I_{PP} = 1\text{A}, T_P=8/20\mu\text{s}$ $I_{PP} = 5\text{A}, T_P=8/20\mu\text{s}$	V_C			19 24	V
Peak pulse power		P_{PP}			120	W
Operation temperature range		T_J	-55		125	$^\circ\text{C}$
Storage temperature range		T_{STG}	-55		150	$^\circ\text{C}$

RATING AND CHARACTERISTIC CURVES (CPDF12V0U-HF)

Fig.1 - 8/20us Peak Pulse Current Wave Form Acc. IEC 61000-4-5

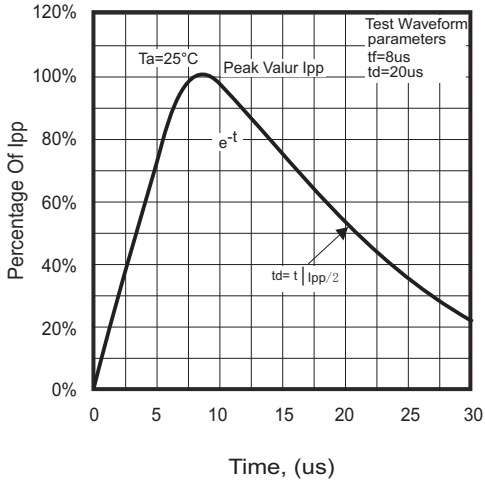

Fig.2 - Power Rating Derating Curve

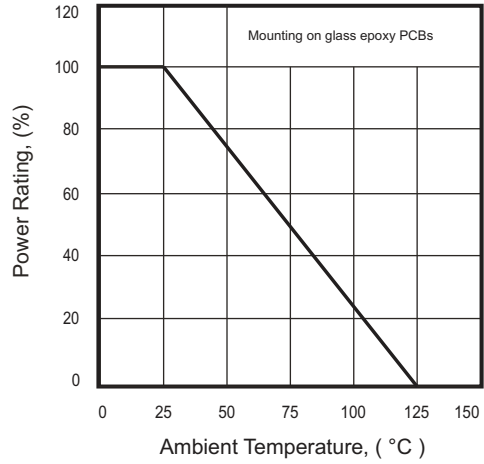

Fig.3 - Clamping Voltage Vs. Peak Pulse Current

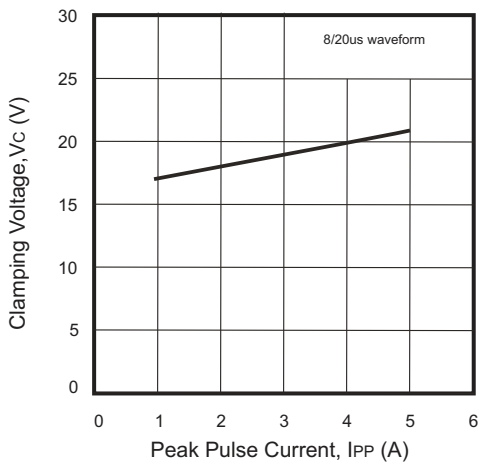

Fig.4 - Clamping Voltage Vs. Forward Peak Pulse Current

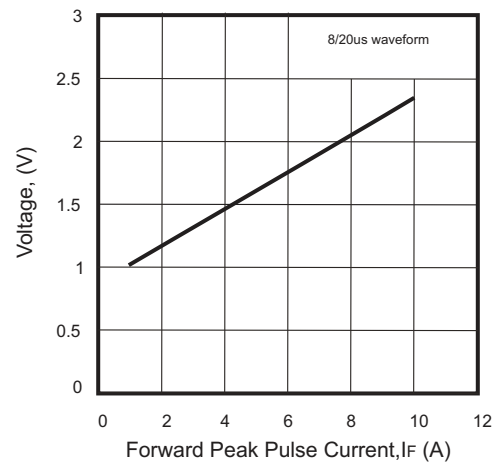
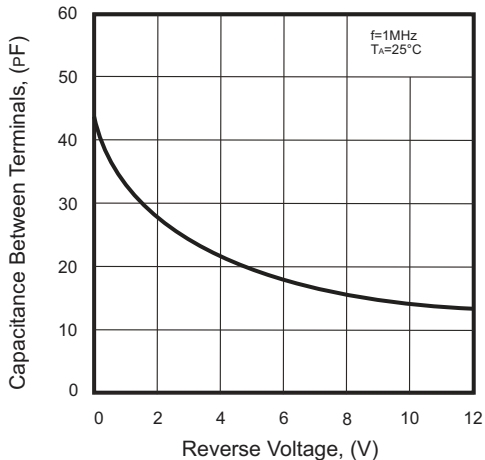
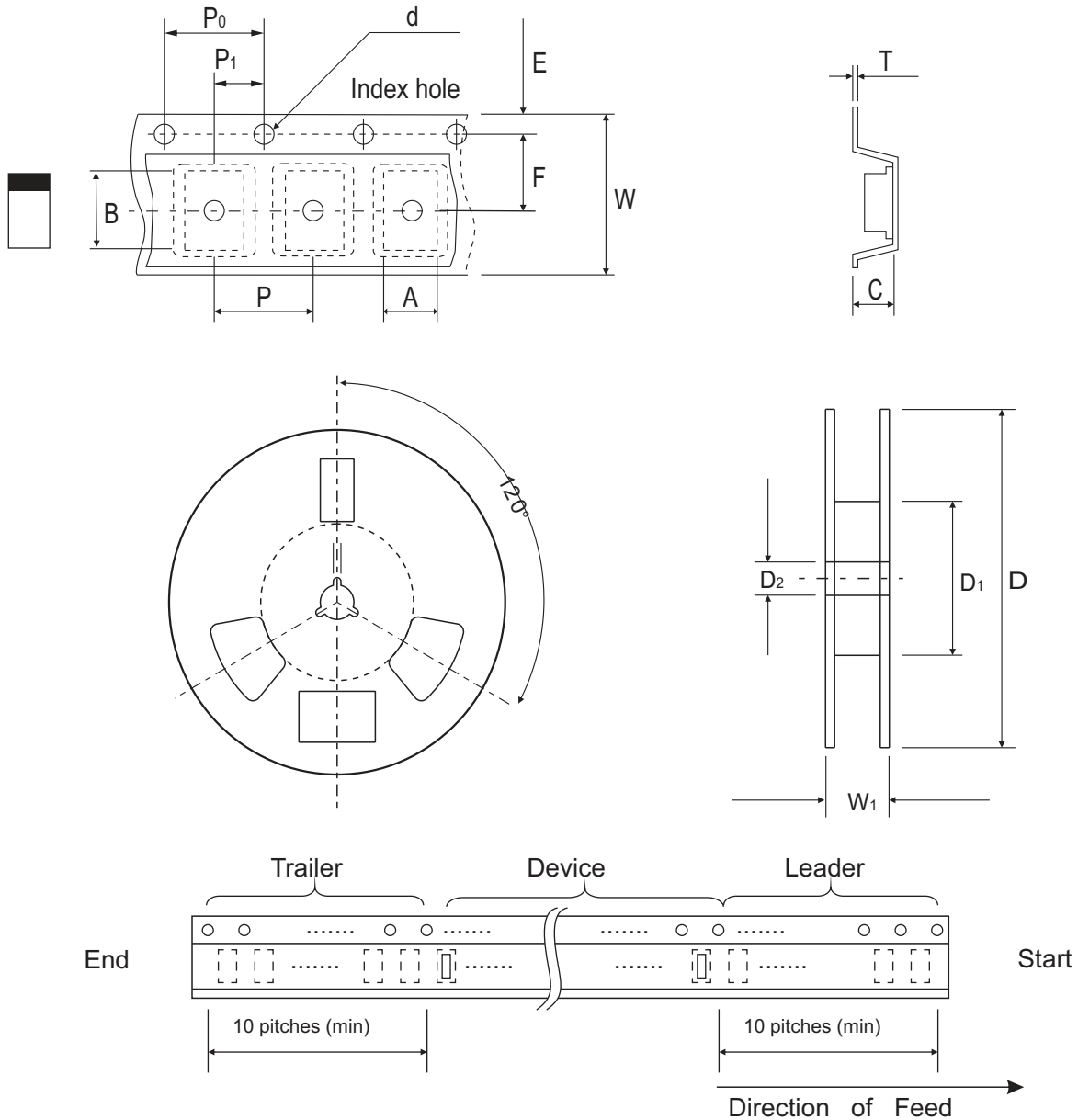

Fig.5 - Capacitance Between Terminals Characteristics



Reel Taping Specification



1005 (SOD-323F)	SYMBOL	A	B	C	d	D	D ₁	D ₂
	(mm)	1.55 ± 0.10	2.65 ± 0.10	1.05 ± 0.10	1.55 ± 0.05	178 ± 1.0	60.0 MIN.	13.00 ± 0.20
	(inch)	0.061 ± 0.004	0.104 ± 0.004	0.041 ± 0.004	0.061 ± 0.002	7.008 ± 0.04	2.362 MIN.	0.512 ± 0.008

1005 (SOD-323F)	SYMBOL	E	F	P	P ₀	P ₁	T	W	W ₁
	(mm)	1.75 ± 0.10	3.50 ± 0.05	4.00 ± 0.10	4.00 ± 0.10	2.00 ± 0.05	0.23 ± 0.05	8.00 ± 0.20	13.5 MAX.
	(inch)	0.069 ± 0.004	0.138 ± 0.002	0.157 ± 0.004	0.157 ± 0.004	0.079 ± 0.002	0.009 ± 0.002	0.315 ± 0.008	0.531 MAX.

Marking Code

Part Number	Marking Code
CPDF12V0U-HF	E12



Suggested PAD Layout

SIZE	1005/SOD-323F	
	(mm)	(inch)
A	2.10	0.083
B	1.20	0.047
C	1.20	0.047
D	3.30	0.130
E	0.90	0.035

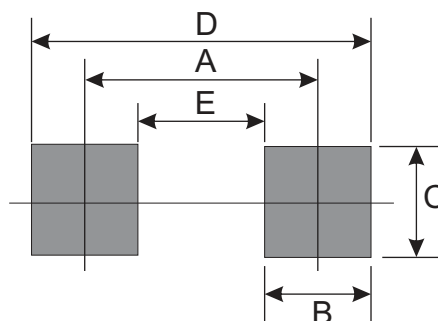

Standard Packaging

Case Type	Qty Per Reel	Reel Size
	(Pcs)	(inch)
1005/SOD-323F	4,000	7