



### Main

Range of Product	Harmony GTU
Product or Component Type	Flat screen
Terminal type	Touchscreen display
[Us] rated supply voltage	12...24 V DC power supply
Supply voltage limits	10.8...28.8 V
Power Consumption in W	17 W
Inrush current	30 A

### Complementary

Integrated connection type	USB 2.0 type A USB 2.0 type mini B
Touchscreen resolution	2048 x 2048
Pixel resolution	1366 x 768
Display size	15.6 inch
Aspect ratio	4:3
Display type	Colour TFT LCD
Display Resolution	1366 x 768 pixels FWXGA
Display colour	16 million colours
Backlight lifespan	50000 hours
Touch panel	Multi-touch projected capacitive technology (PCT) 50000000 cycles
Function Available	Brightness sensor
Type of cooling	Natural convection
Type of Installation	Indoor installation
Cut-out dimensions	396 (+ 1/- 0) x 277 (+ 1/- 0) mm
Width	16.30 in (414 mm)
Height	11.61 in (295 mm)
Depth	2.72 in (69 mm)
Net Weight	11.02 lb(US) (5 kg)

### Environment

IP degree of protection	Front panel IP66 Front panel IP67
NEMA degree of protection	NEMA 4X front panel
Standards	UL 508 ANSI/ISA 12-12-01 Class I division 2 CSA C22.2 No 213 CSA C22.2 No 142 IEC 61132-2
Product certifications	KC CE RCM CULus
Ambient air temperature for operation	32...131 °F (0...55 °C) EN 61131-2
Ambient air temperature for storage	-4...140 °F (-20...60 °C)
Relative Humidity	10...90 % non-condensing
Operating altitude	6561.68 ft (2000 m)

Vibration resistance	3.5 mm constant amplitude 5...9 Hz) EN/IEC 61131-2 9.8 m/s <sup>2</sup> 9...150 Hz) EN/IEC 61131-2
Shock resistance	147 m/s <sup>2</sup> EN/IEC 61131-2
Electromagnetic compatibility	Electrostatic discharge immunity testlevel 3 EN/IEC 61000-4-2





## Ordering and shipping details

Category	22567-MAGELIS HMI GTU
Discount Schedule	MC2
GTIN	3606481203465
Nbr. of units in pkg.	1
Package weight(Lbs)	13.83 lb(US) (6.274 kg)
Returnability	Yes

## Packing Units

Unit Type of Package 1	PCE
Package 1 Height	17.80 in (45.2 cm)
Package 1 width	7.36 in (18.7 cm)
Package 1 Length	21.18 in (53.8 cm)
Unit Type of Package 2	P12
Number of Units in Package 2	14
Package 2 Weight	220.10 lb(US) (99.836 kg)
Package 2 Height	35.43 in (90 cm)
Package 2 width	31.50 in (80 cm)
Package 2 Length	47.24 in (120 cm)

## Offer Sustainability

Sustainable offer status	Green Premium product
California proposition 65	WARNING: This product can expose you to chemicals including: Lead and lead compounds, which is known to the State of California to cause cancer and birth defects or other reproductive harm. For more information go to <a href="http://www.P65Warnings.ca.gov">www.P65Warnings.ca.gov</a>
REACH Regulation	 <a href="#">REACH Declaration</a>
REACH free of SVHC	Yes
EU RoHS Directive	Pro-active compliance (Product out of EU RoHS legal scope)  <a href="#">EU RoHS Declaration</a>
Mercury free	Yes
RoHS exemption information	 <a href="#">Yes</a>
China RoHS Regulation	 <a href="#">China RoHS Declaration</a>
WEEE	The product must be disposed on European Union markets following specific waste collection and never end up in rubbish bins.

External Dimensions

Display Unit with Box Module

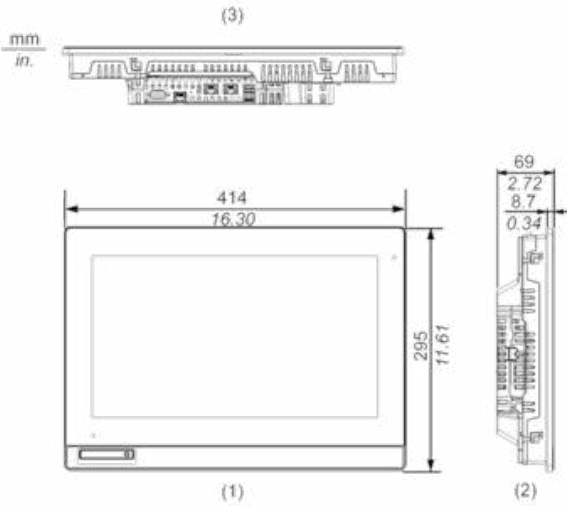

- (1) Front
- (2) Left
- (3) Bottom

Installation with Installation Fasteners and Dimensions with Cables

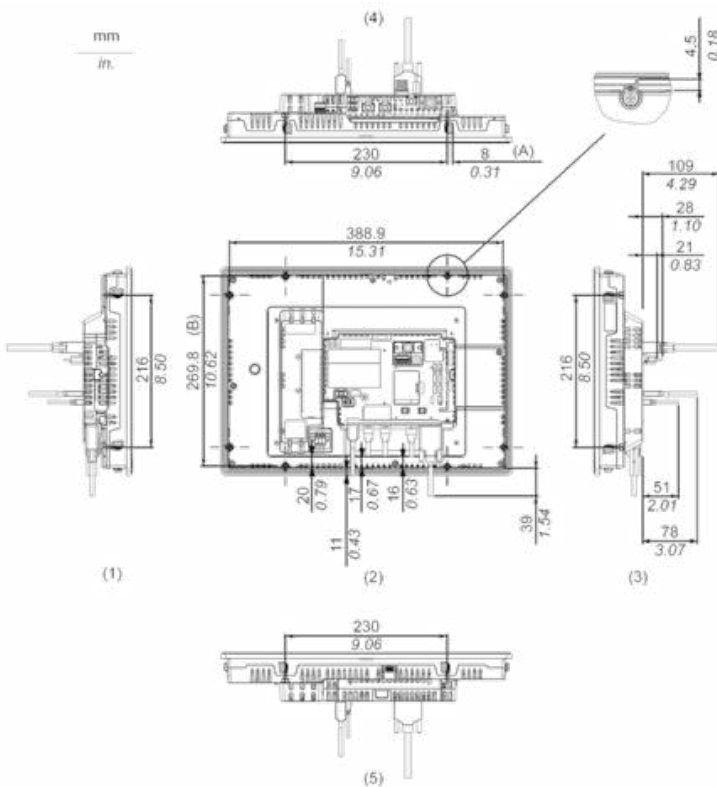

- (A) Rotation area of the fastener
- (B) Pitch of the center of installation fastener screws
- (1) Right
- (2) Front

- (3) Left
- (4) Bottom
- (5) Top

Panel Cut Dimensions

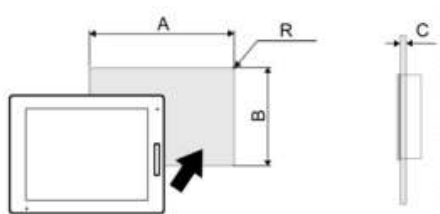

Dimensions in mm

A	B	C	R
396 (+1/-0)	277 (+1/-0)	1.6...5	3 max.

Dimensions in in.

A	B	C	R
15.59 (+0.04/-0)	10.91 (+0.04/-0)	0.06...0.2	0.12 max.

Installation Requirements

Mounting Angle

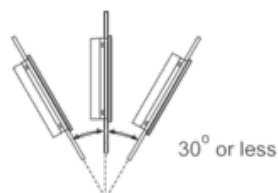

When installing this product in a slanted position with an incline more than 30°, the ambient temperature must not exceed 40 °C (104 °F). You may need to use forced air cooling (fan, A/C) to ensure the ambient operating temperature is 40 °C or less (104 °F or less).

Clearance

