



SERIES 500 SWITCHES

SLIDE SWITCHES

TACT SWITCHES

NAVIGATION SWITCHES

PUSHBUTTON SWITCHES

TOGGLE SWITCHES

ROCKER SWITCHES

SLIDE SWITCHES

SNAP-ACTION SWITCHES

DIP SWITCHES

KEYLOCK SWITCHES

ROTARY SWITCHES

DETECTOR SWITCHES

CAP OPTIONS

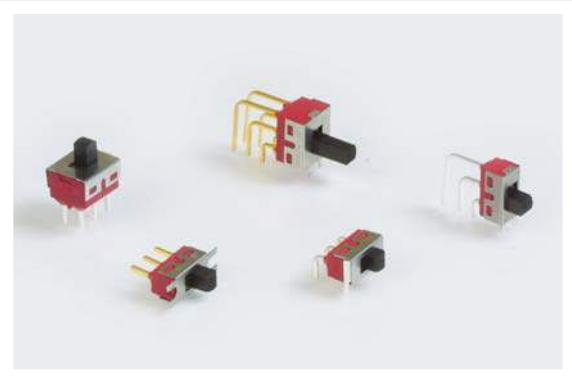

SPECIFICATIONS

Contact Rating:	Gold, 0.4 VA @ 20 VAC or DC Silver, 5A @ 120 VAC, 2A @ 250 VAC
Life Expectancy:	50,000 make-and-break cycles at full load
Contact Resistance:	10 mΩ max. typical @ 2-4 VDC 100mA for both silver and gold plated contacts
Insulation Resistance:	1,000 MΩ min.
Dielectric Strength:	1,000 V rms at sea level
Operating Temperature:	-30°C to 85°C

FEATURES & BENEFITS

- ▶ Single & double pole options
- ▶ Multiple actuator height options
- ▶ Panel & PC board mountable

APPLICATIONS/MARKETS

- ▶ Computer servers/peripherals
- ▶ Consumer electronics
- ▶ Instrumentation
- ▶ Test & measurement

HOW TO ORDER

SERIES	MODEL NO.	ACTUATOR	TERMINATION	CONTACT MATERIAL	SEAL	MOUNTING TAB
500	SSP1 SSP2 SSP3	S1 S2 S3 S4	M1 M2 M3 M5-1 M5-2 M5-3 M5-4 M6 M7 VS2	Q = Silver R = Gold	E = Epoxy Sealed	A = Without Tabs B = With Tabs

▶ ▶ ▶ Example Ordering Number
500-SSP2-S4-M1-Q-E-B

SDP1 SDP3	S1 S2 S3 S4	M1 M2 M3 M5-1 M5-2 M5-3 M5-4 M6 M7 VS2	Q = Silver R = Gold	E = Epoxy Sealed	A = Without Tabs B = With Tabs
--------------	----------------------	---	------------------------	------------------	-----------------------------------

▶ ▶ ▶ Example Ordering Number
500-SDP1-S1-M6-R-E-A

Specifications subject to change without notice.10.18.2022



SPDT

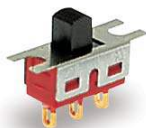

2 Comm.
1 3

SCHEMATIC

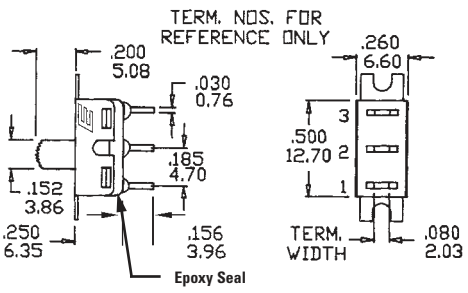
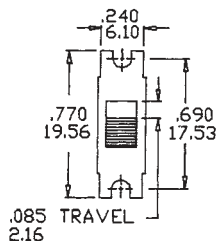

Model No.	POS 1	POS 2	POS 3
SSP-1	ON	NONE	ON
SSP-2	ON	NONE	(ON)
SSP-3	ON	OFF	ON
Term. Comm.	2-1	OPEN	2-3

() = Momentary

DPDT



2 Comm. 5 Comm.
1 3 4 6

SCHEMATIC

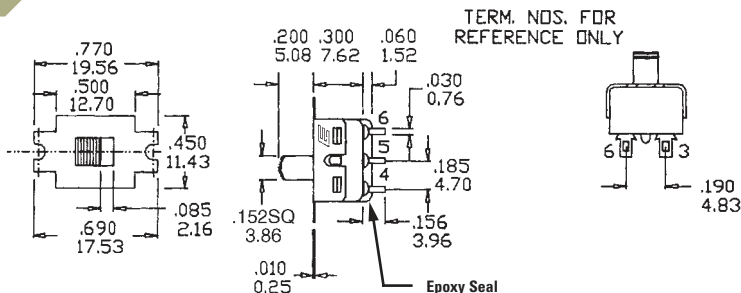

Model No.	POS 1	POS 2	POS 3
SDP-1	ON	NONE	ON
SDP-3	ON	OFF	ON
Term. Comm.	2-1, 5-4	OPEN	2-3, 5-6

ACTUATOR OPTIONS

S1 STD†

† Standard for all DPDT versions.

S2

S3

S4

S5

* Subtract 0.012 (0.301) from actuator height for M6, M7 PC mounting options.

TERMINATION OPTIONS

M1 SOLDER LUG

0.030 (0.76) THK

M2 P.C. MOUNT

0.030 (0.76) THK

M3 QUICK CONNECT

0.030 (0.76) THK
MATING QUICK CONNECTOR
AMP P/N 60900-1

M5 WIRE WRAP

Option Code	Dim. 'A'
M51	.736 (18.70)
M52	.953 (24.20)
M53	.415 (10.55)
M54	1.062 (26.97)



SERIES 500 SWITCHES

SLIDE SWITCHES

TACT SWITCHES

NAVIGATION SWITCHES

PUSHBUTTON SWITCHES

TOGGLE SWITCHES

ROCKER SWITCHES

SLIDE SWITCHES

SNAP-ACTION SWITCHES

DIP SWITCHES

KEYLOCK SWITCHES

ROTARY SWITCHES

DETECTOR SWITCHES

CAP OPTIONS

M6

SPDT

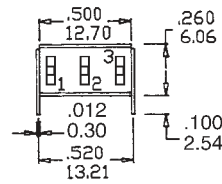
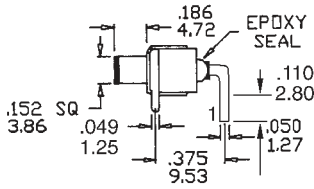
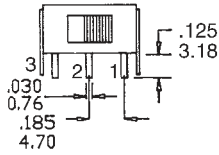

TERM. NOS. FOR REFERENCE ONLY

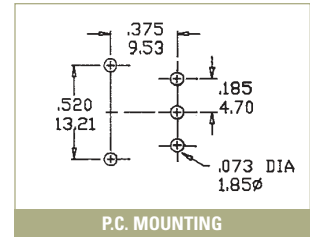

P.C. MOUNTING

M6

DPDT

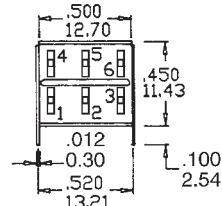
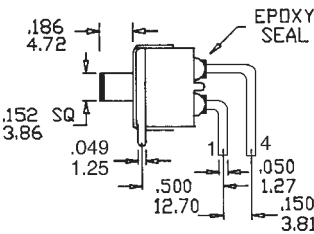
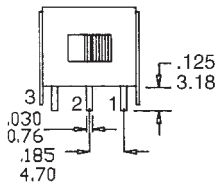

TERM. NOS. FOR REFERENCE ONLY

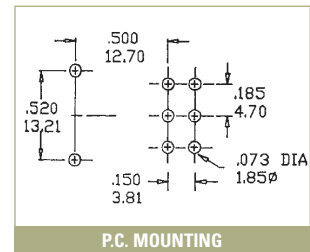

P.C. MOUNTING

M7

SPDT

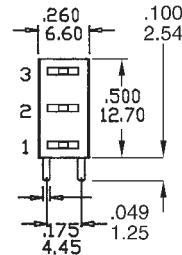
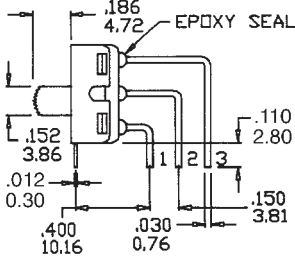
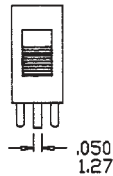

TERM. NOS. FOR REFERENCE ONLY

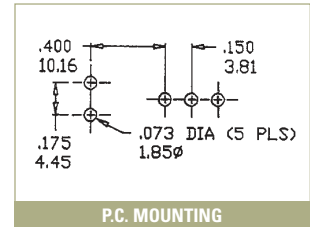

P.C. MOUNTING

M7

DPDT

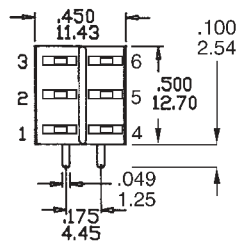
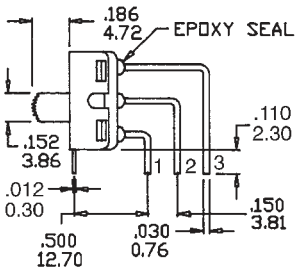
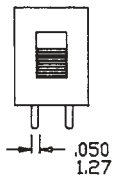

TERM. NOS. FOR REFERENCE ONLY

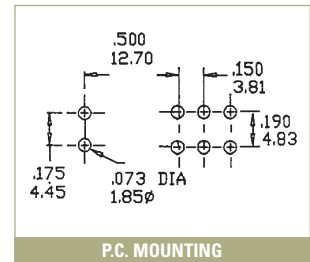

P.C. MOUNTING

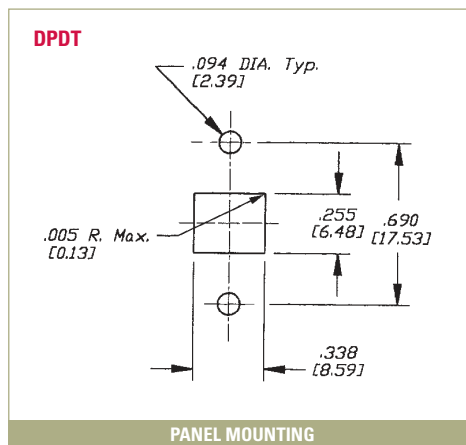
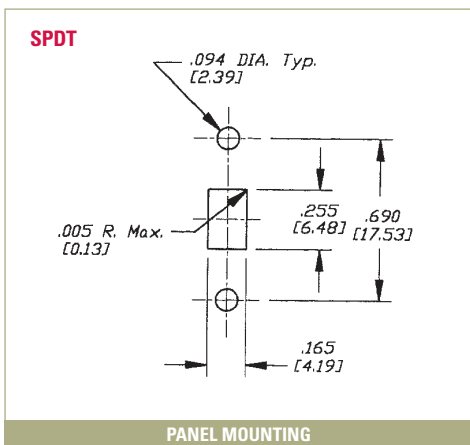

MOUNTING TABS

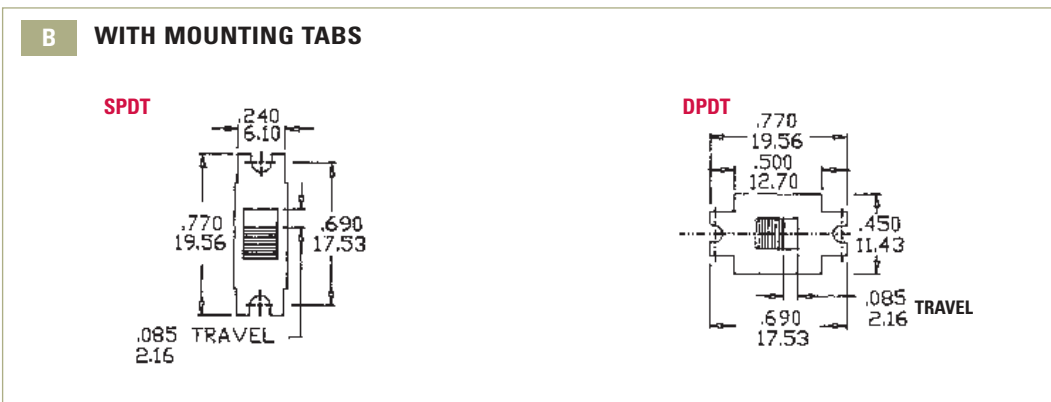
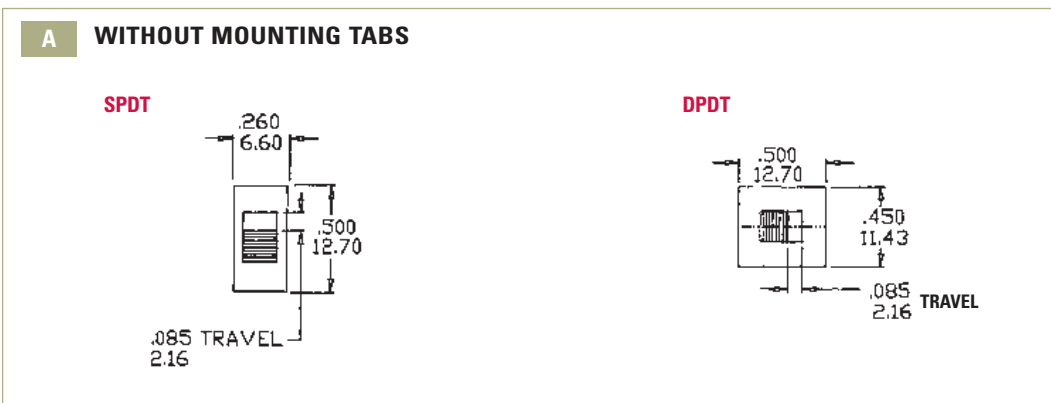

CONTACT MATERIAL OPTIONS

Q	Fixed Terminal: Silver plated copper alloy
	Moving Contact: Silver plated copper alloy
	Rating: 5 Amps with resistive load @ 120VAC or 28VDC 2 Amps with resistive load @ 250VAC

R	Fixed Terminal: Copper alloy with gold plate over nickel plate
	Moving Contact: Copper alloy with gold plate over nickel plate
	Rating: 0.4 Volt-Amps (VA) max. @ 20V max. (AC or DC)