

Powered by



# HC 1221W/WP ▶ 12V 21W

HC 1221W/WP is specially designed for high efficient discharge application. Its invisible terminals can be inserted PC board directly. HC series battery can serve more than 260 cycles at 100 % discharge in cycle service, up to 5 years in standby service.



## Specification

Cells Per Unit	6
Voltage Per Unit	12
Capacity	21W @ 15min-rate to 1.67V per cell @25°C (77°F)
Weight	Approx. 1.79 kg(3.95 lbs)
Maximum Discharge Current	60A(5sec)
Internal Resistance	Approx. 25mΩ
Operating Temperature Range	Discharge: -15°C~50°C ( 5°F~122°F) Charge: -15 °C~40°C ( 5°F~104°F) Storage: -15°C~40°C ( 5°F~104°F)
Nominal Operating Temperature Range	25°C±3°C(77°F±5°F)
Float Charging Voltage	13.5 to 13.8 VDC/unit Average at 25°C(77°F)
Recommended Maximum Charging Current Limit	2.1A
Equalization and Cycle Service	14.4 to 15.0 VDC/unit Average at 25°C(77°F)
Self Discharge	CSB Batteries can be stored for more than 6 months at 25°C(77°F). Please charge batteries before using. For higher temperatures the time interval will be shorter.
Terminal	C1/C2-Faston Tab187/250 ( W: C1 / WP: C2)
Container Material	ABS(UL 94-HB/File E50263)*Flammability resistance of (UL 94-V0/File E88637) can be available upon request.



CSB-manufactured VRLA batteries are UL-recognized components under UL924 and UL1989.

CSB is also certified by ISO 9001 and ISO 14001.

## Dimensions :

Unit: mm (inch)

Overall Height (H)	Container height (h)	Length (L)	Width (W)
103.5±1.5 (4.07±0.06)	--	139.7±1.5 (5.50±0.06)	48.0±1.0 (1.89±0.04)

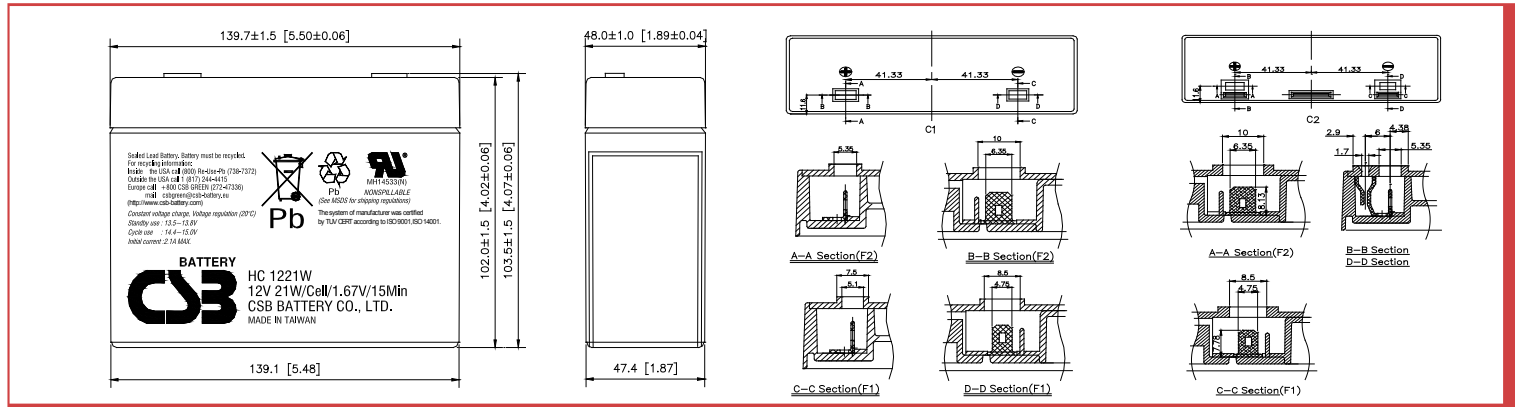

## Constant Current Discharge Characteristics Unit:A (25°C, 77°F)

F.V/Time	2MIN	4MIN	6MIN	8MIN	10MIN	15MIN	20MIN	30MIN	60MIN	90MIN
1.60V	46.4	31.2	24.4	20.3	17.1	12.3	10.1	7.18	4.02	2.83
1.67V	43.4	29.8	23.8	20.0	16.9	12.2	10.0	7.16	4.01	2.71
1.70V	40.2	28.5	23.0	19.5	16.5	12.1	9.93	7.15	4.00	2.66
1.75V	36.6	27.0	22.0	18.9	16.1	11.9	9.82	7.14	3.99	2.56
1.80V	32.8	25.1	20.8	18.2	15.7	11.7	9.71	7.13	3.98	2.46
1.85V	28.6	22.9	19.5	17.3	15.2	11.5	9.59	7.12	3.97	2.36

## Constant Power Discharge Characteristics Unit:W (25°C, 77°F)

F.V/Time	2MIN	4MIN	6MIN	8MIN	10MIN	15MIN	20MIN	30MIN	60MIN	90MIN
1.60V	557	374	293	238	202	148	121	86.1	48.2	33.9
1.67V	521	358	285	233	199	147	120	85.9	48.1	32.8
1.70V	483	340	274	227	196	145	119	85.8	48.0	31.6
1.75V	440	320	263	220	191	144	117	85.6	47.9	30.5
1.80V	393	299	250	212	186	141	116	85.4	47.8	29.4
1.85V	343	275	234	203	180	138	114	85.3	47.7	28.3

### Trickle (or Float) Service Life

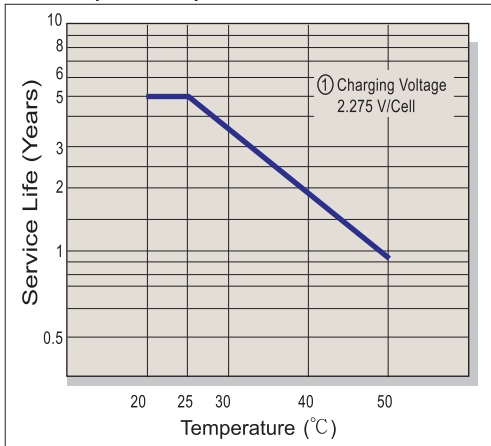

### Capacity Retention Characteristic

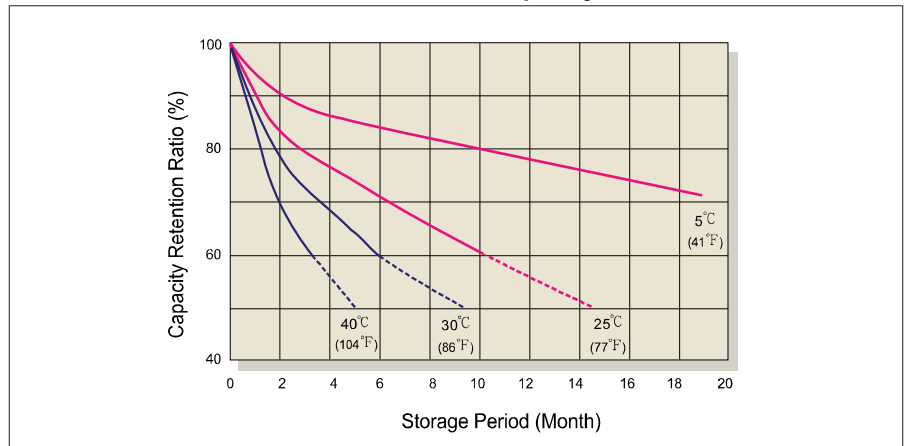

### Battery Voltage and Charge Time for Standby Use

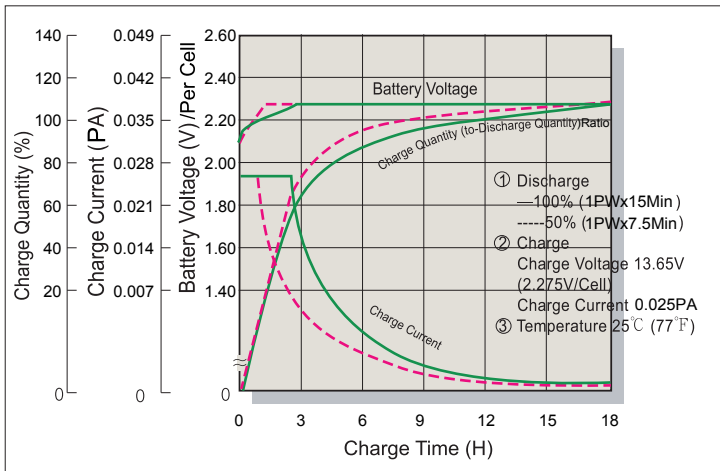

### Cycle Service Life

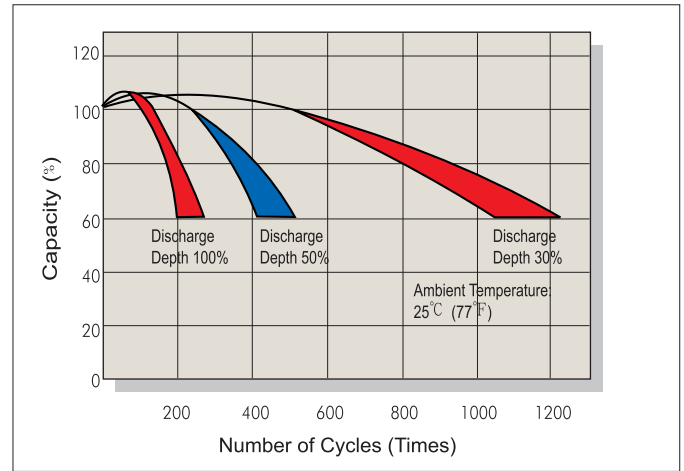

### Battery Voltage and Charge Time for Cycle Use

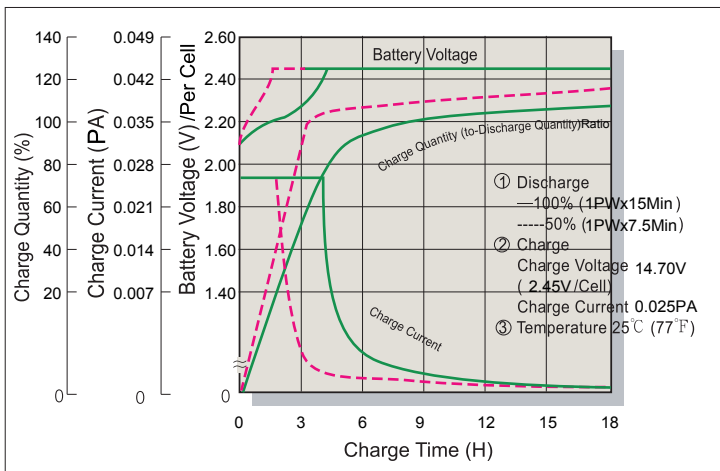

### Terminal Voltage (V) and Discharge Time

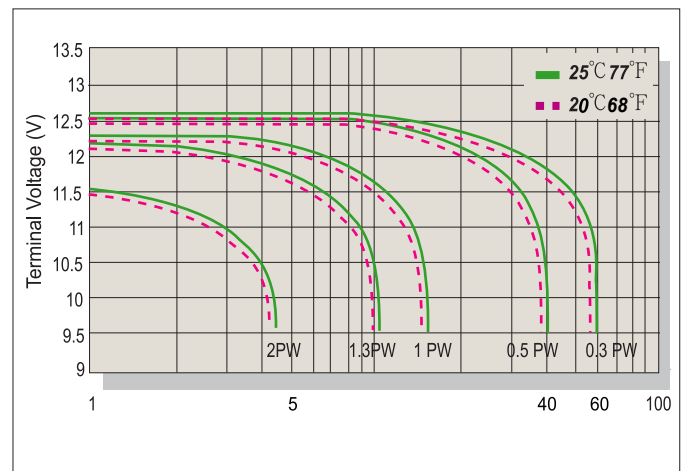

### Charging Procedures

Application	Charge Voltage(V/Cell)			Max.Charge Current
	Temperature	Set Point	Allowable Range	
Cycle Use	25°C(77°F)	2.45	2.40~2.50	0.1PA
Standby	25°C(77°F)	2.275	2.25~2.30	

### Discharge Current VS. Discharge Voltage

Final Discharge Voltage V/Cell	1.75	1.70	1.60	1.30
Discharge Power(W)	0.1P>(W)	0.1P≤(W)<0.25P	0.25P≤(W)<1.0P	(W)≥1.0P

Sales Office URL: [WWW.CSB-BATTERY.COM](http://WWW.CSB-BATTERY.COM)

**GLOBAL HQ**  
**CSB BATTERY CO., LTD. (TAIWAN)**  
 Tel : +886-2-2880-5600  
 Fax : +886-2-2888-3300  
 mail : service@csb-battery.com.tw

**BEIJING OFFICE. (CHINA)**  
**CSB BATTERY TECHNOLOGIES (BEIJING) CO., LTD.**  
 Tel : +86-10-5820-5336/5338  
 Fax : +86-10-58203053  
 mail : chinasl@csb-battery.com

**AMERICA HQ**  
**CSB BATTERY TECHNOLOGIES INC. (U.S.A)**  
 Tel : +1-817-244-7777/1-(800)3-CSB-USA(272872)  
 Fax : +1-817-244-4445  
 mail : csb@csb-battery.com

**SHANGHAI OFFICE. (CHINA)**  
**CSB BATTERY LOGISTIC (SHANGHAI) CO., LTD.**  
 Tel : +86-21-5046-1622/5046-0833  
 Fax : +86-21-5064-3314  
 mail : chinasl@csb-battery.com

**EUROPE HQ**  
**CSB Battery Europe BV.**  
 Tel : +31(0)-180-418-140  
 Fax : +31(0)-180-418-327  
 mail : eurosales@csb-battery.eu

**SHENZHEN OFFICE. (CHINA)**  
**CSB BATTERY LOGISTIC (SHANGHAI) CO., LTD.**  
 Tel : +86-755-8831-6488/6396/6356  
 Fax : +86-755-8831-6548  
 mail : she@csb-battery.com.cn