

ECS-MPIL0630

SMD Power Inductor

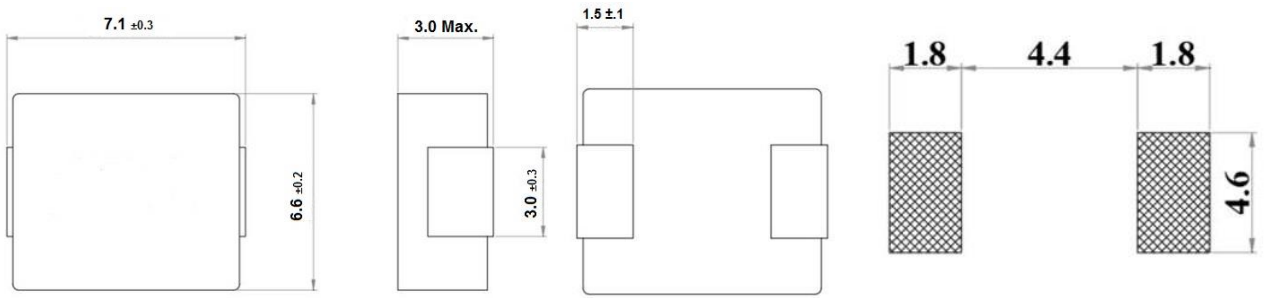

1. Mechanical Dimension [Unit : mm]



2. Electrical Characteristics

ECS-MPIL0630 Series

Part No.	Inductance ($\mu\text{H} \pm 20\%$)	DC Resistance ($\text{m}\Omega$ MAX)	DC Resistance ($\text{m}\Omega$ TYP.)	Rated Current (A MAX)	Heat Rating Current DC(A)
ECS-MPIL0630-R47MC	0.47	4.1	3.4	20.0	18.0
ECS-MPIL0630-R56MC	0.56	4.5	4.25	18.0	16.5
ECS-MPIL0630-R68MC	0.68	5.3	4.8	17.0	16.0
ECS-MPIL0630-R82MC	0.82	6.0	5.4	16.0	14.0
ECS-MPIL0630-1R0MC	1.0	9.2	8.4	15.0	12.0
ECS-MPIL0630-1R5MC	1.5	12.1	10.6	14.0	10.0
ECS-MPIL0630-2R2MC	2.2	15.0	13.5	10.0	8.0
ECS-MPIL0630-3R3MC	3.3	22.0	18.0	9.5	6.5
ECS-MPIL0630-4R7MC	4.7	33.0	28.0	6.5	5.5
ECS-MPIL0630-5R6MC	5.6	42.0	37.5	6.3	4.8
ECS-MPIL0630-6R8MC	6.8	50.0	43.9	6.0	4.5
ECS-MPIL0630-100MC	10	68.0	62.0	5.5	4.0
ECS-MPIL0630-150MC	15	95.0	90.0	4.0	3.0
ECS-MPIL0630-220MC	22	135.0	125.0	3.0	2.5

Storage and Operating Temperature: $-40 \sim +125 \text{ }^\circ\text{C}$

Measuring Frequency (L) : 100KHz/0.1V

Rated Current: D.C. Current at which the Inductance drops 30%(MAX.) from its value without current

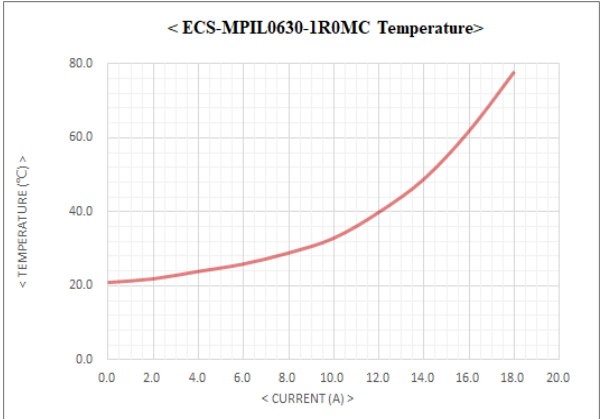
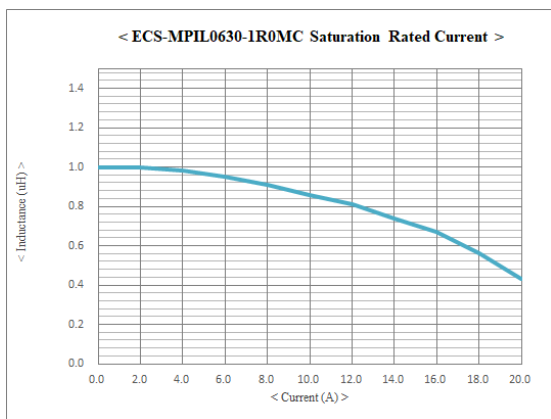
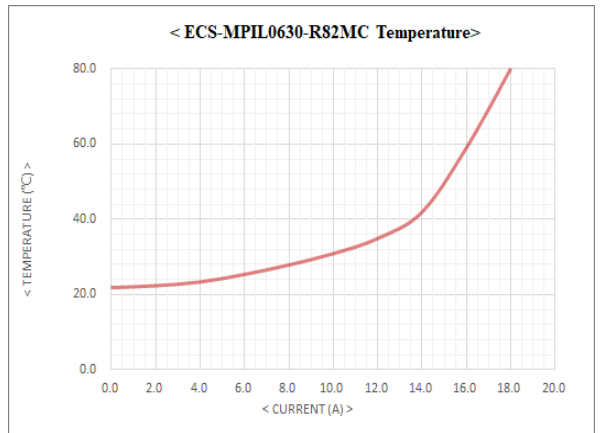
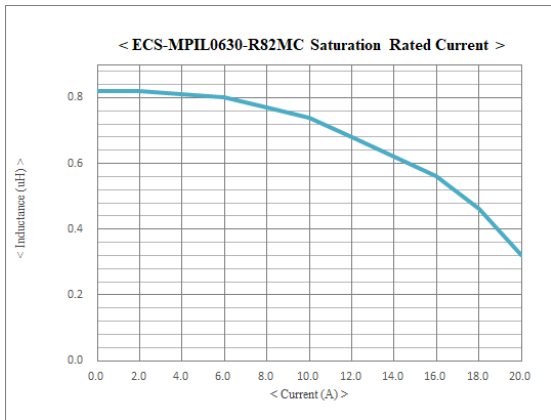
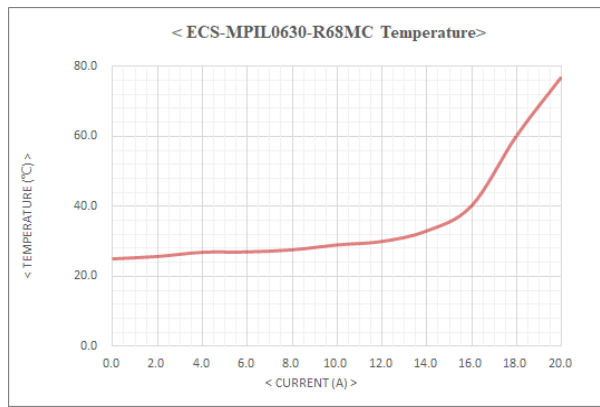
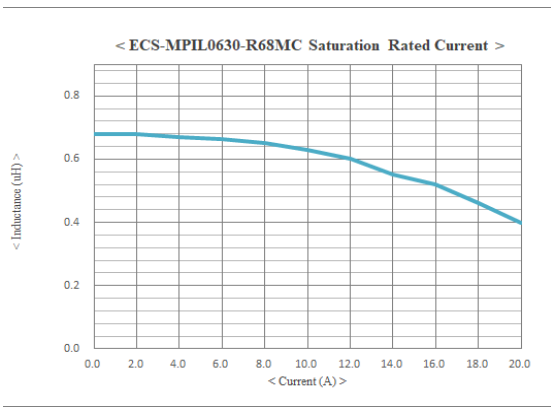
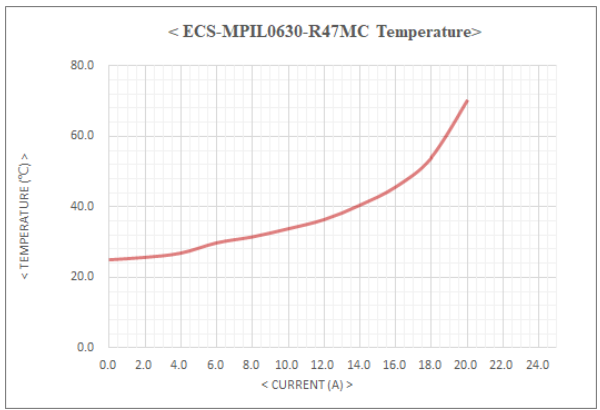
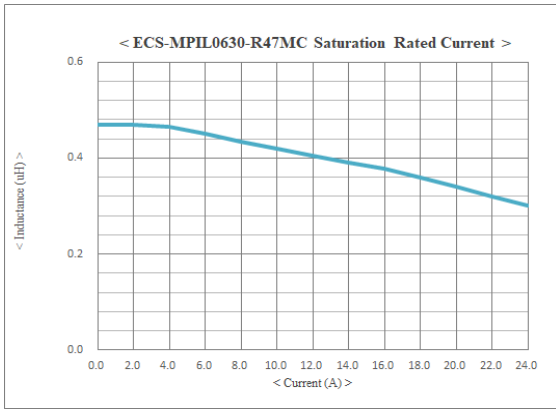

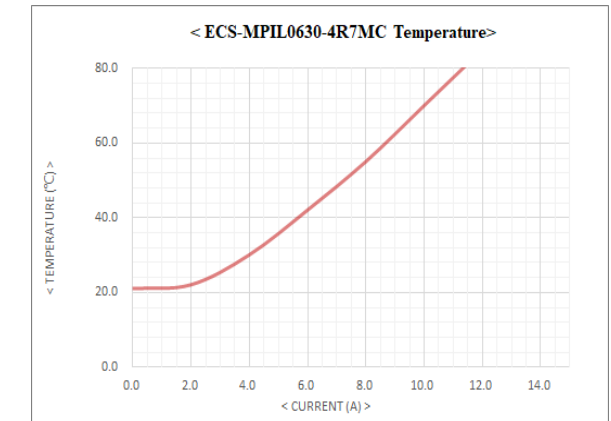
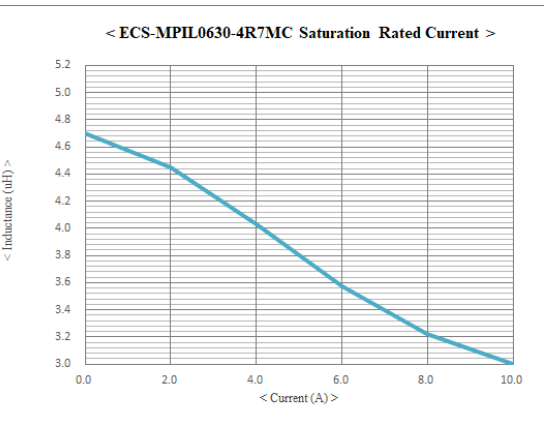
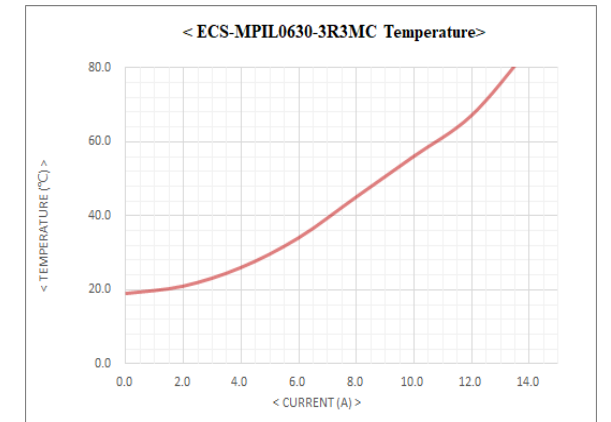
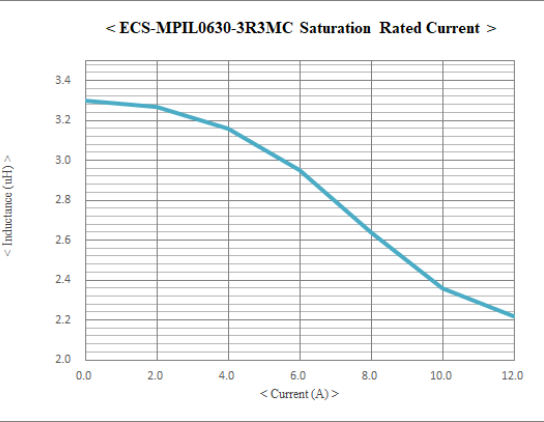
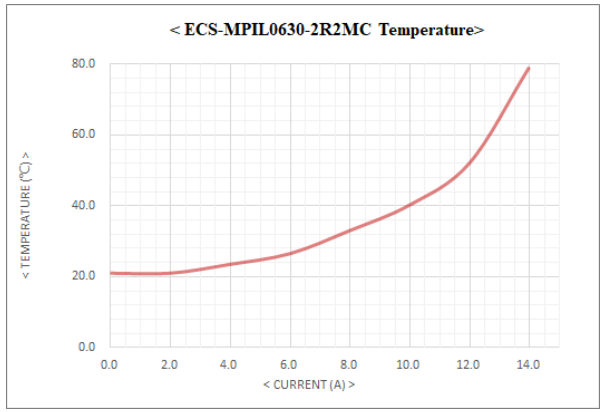
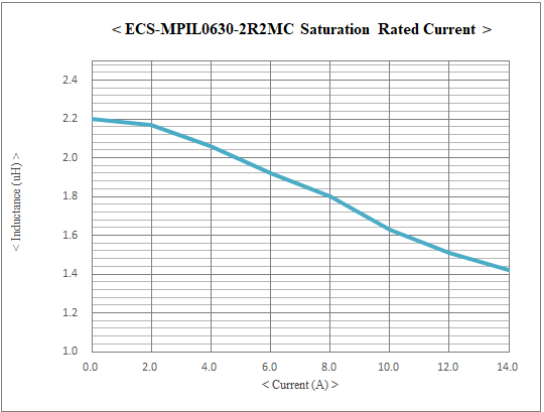
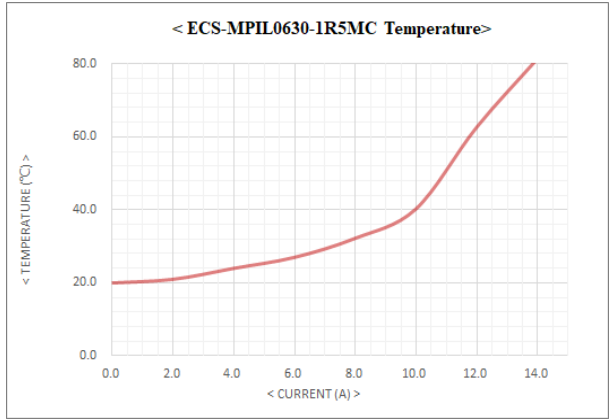
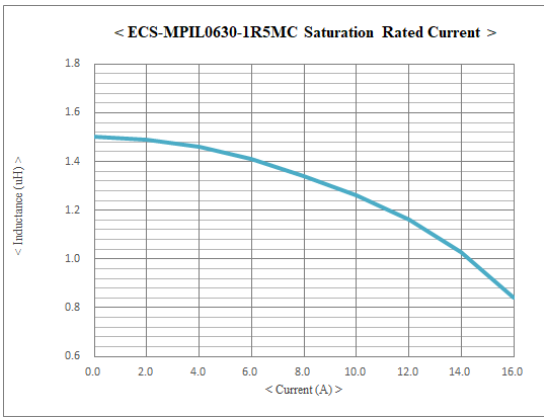

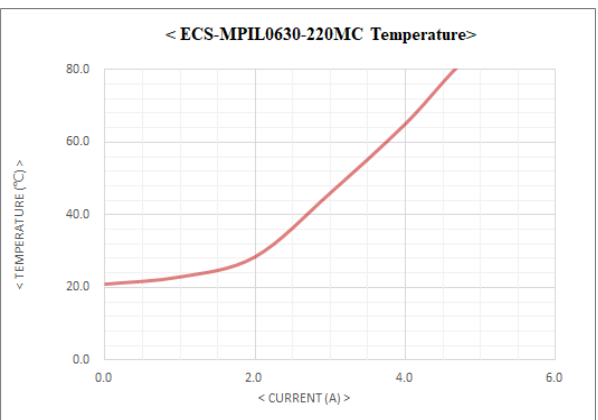
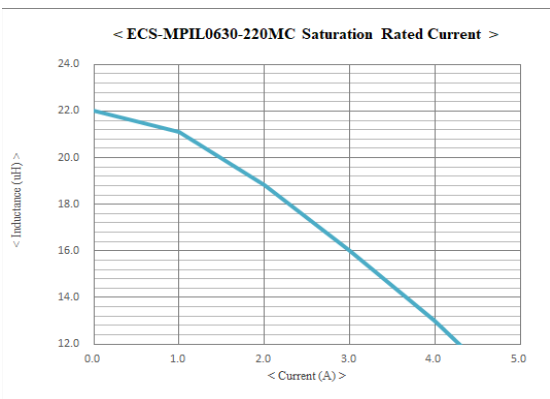
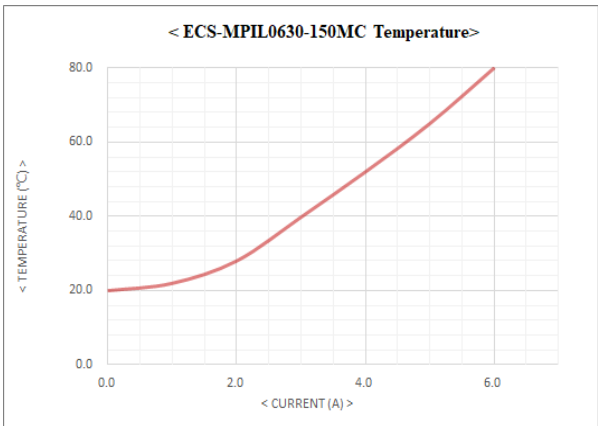
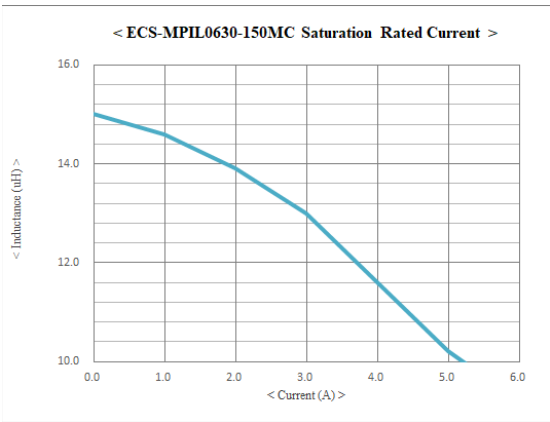
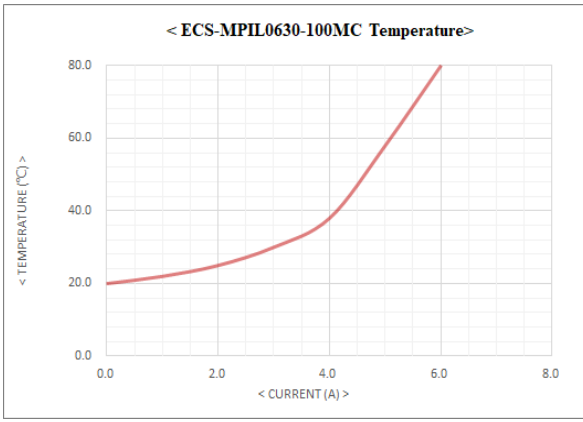
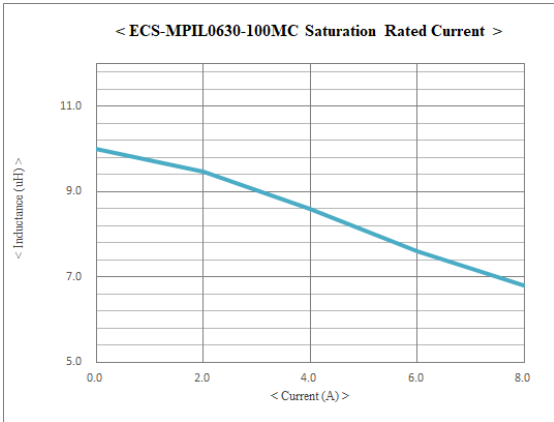
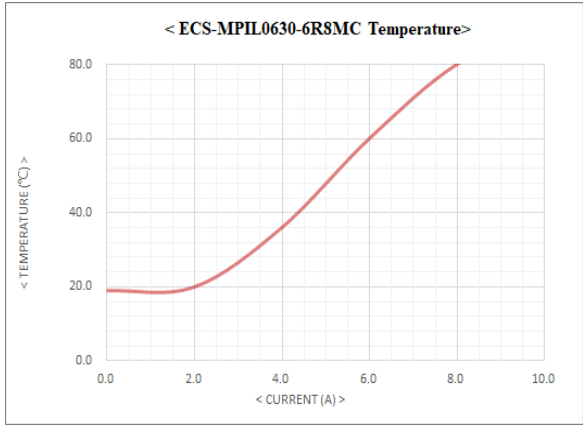
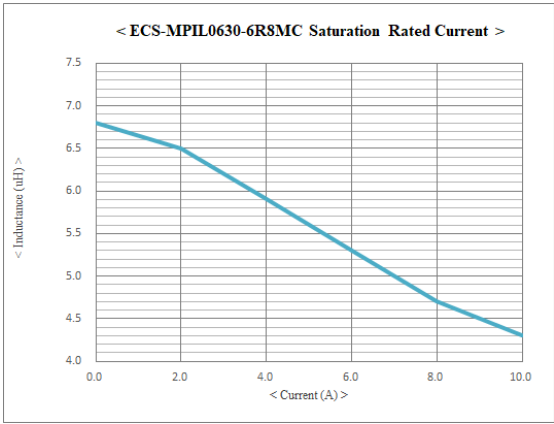

7. REEL DIMENSION (mm)

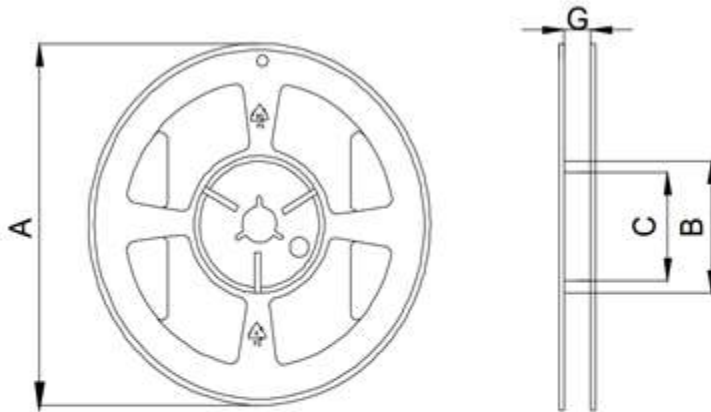

A	B	C	G
330	100	13	16

8. EMBOSSED TAPE DIMENSIONS (mm)

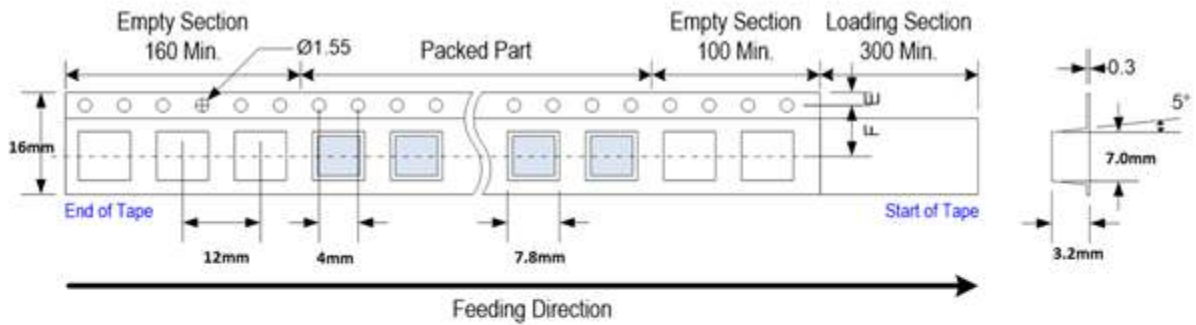

9. PEEL-OFF STRENGTH

