

SUPER BLUE

MV8B11

MV8B12

### PACKAGE DIMENSIONS

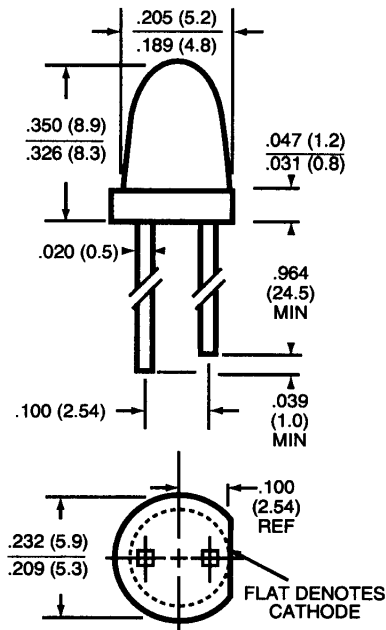

### DESCRIPTION

These T-1 3/4 super-bright blue LEDs have a narrow viewing angle of 10° for concentrated light output. The blue diode chip is constructed with GaN/SiC technology and emits a peak wavelength of 430 nm.

### FEATURES

- Popular T-1 3/4 package
- Low drive current
- Solid state reliability
- Super high brightness
- Water clear optics
- Standard 100 mil. lead spacing

- Note: 1) All dimensions are in inches (mm).  
 2) Lead spacing is measured where the leads emerge from the package.  
 3) Protruded resin under the flange is 1.5mm (0.059") max.

### ABSOLUTE MAXIMUM RATINGS (T<sub>A</sub>=25°C unless otherwise specified)

DC Forward Current (I <sub>F</sub> )	30 mA
Peak Forward Current (I <sub>F</sub> ) @ f = 1.0 KHz, Duty factor = 1/10	100 mA
Power Dissipation (P <sub>d</sub> )	115 mW
Reversed Voltage (V <sub>R</sub> ) I <sub>R</sub> = 10 μA	5
Operating Temperature Range	-40°C to +100°C
Storage Temperature Range	-40°C to +100°C
Lead Soldering Time	5 secs @ 260°C for wave solder; 10 secs @ 260°C for IR reflow

#### ELECTRO-OPTICAL CHARACTERISTICS (T<sub>A</sub>=25°C unless otherwise specified)

Part Number:		<u>MV8B11</u>	<u>MV8B12</u>	<u>Test Condition</u>
Luminous Intensity (mcd)	Minimum	400	630	I <sub>F</sub> = 20 mA
	Typical	600	940	
Forward Voltage (V <sub>F</sub> )	Typical	3.8	3.8	I <sub>F</sub> = 20 mA
	Maximum	4.5	4.5	
Peak Wavelength (nm)		430	430	I <sub>F</sub> = 20 mA
Spectral Line Half Width (nm)		65	65	I <sub>F</sub> = 20 mA
Viewing Angle (degrees)		10	10	I <sub>F</sub> = 20 mA

#### TYPICAL ELECTRO-OPTICAL CHARACTERISTIC CURVES (T<sub>A</sub> = 25°C)

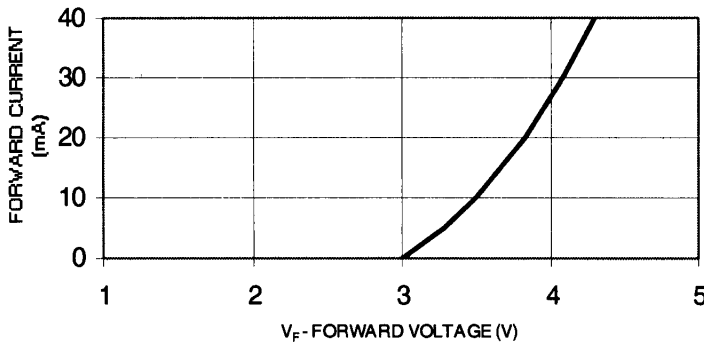

Fig 1. Forward Current vs. Forward Voltage

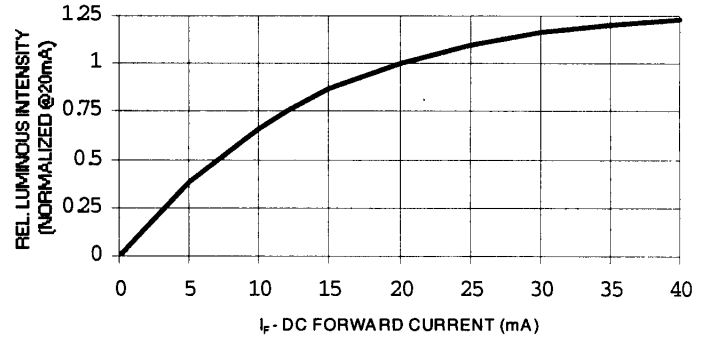

Fig 2. Rel. Luminous Intensity vs. DC Forward Current

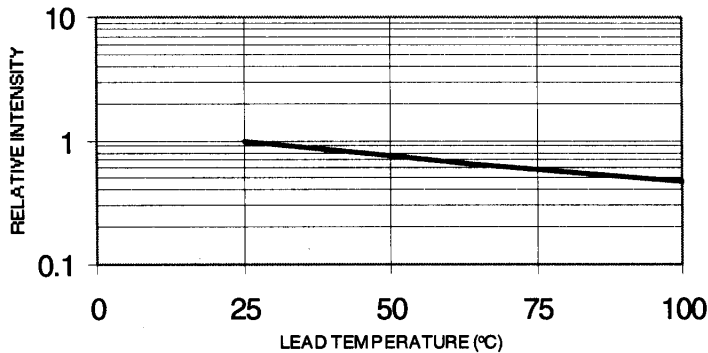

Fig 3. Rel. Intensity vs. Lead Temperature  
(Pulsed 20 mA; 300 us pulse, 10 ms period)

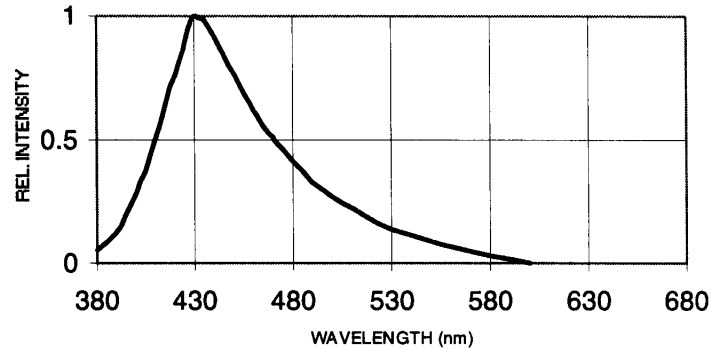

Fig 4. Rel. Intensity vs. Wavelength

### TYPICAL ELECTRO-OPTICAL CHARACTERISTIC CURVES (T<sub>A</sub> = 25°C)

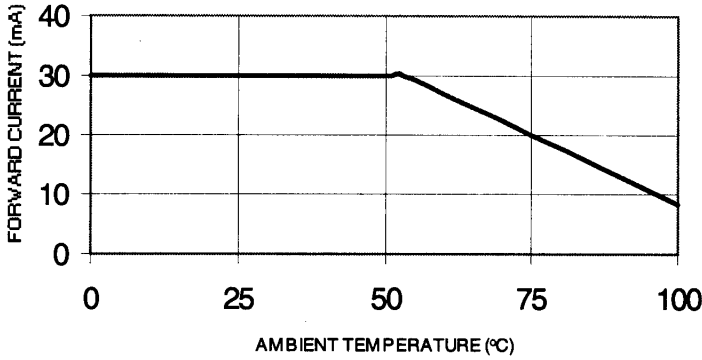

Fig 5. Forward Current vs. Ambient Temperature

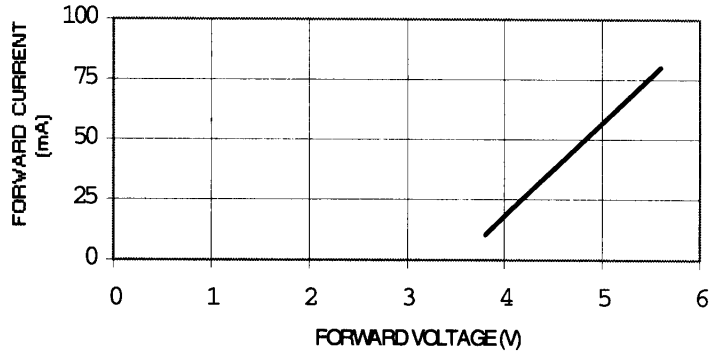

Fig. 6 Peak Forward Voltage vs. Forward Current  
(100 us test pulse, 1% duty cycle)

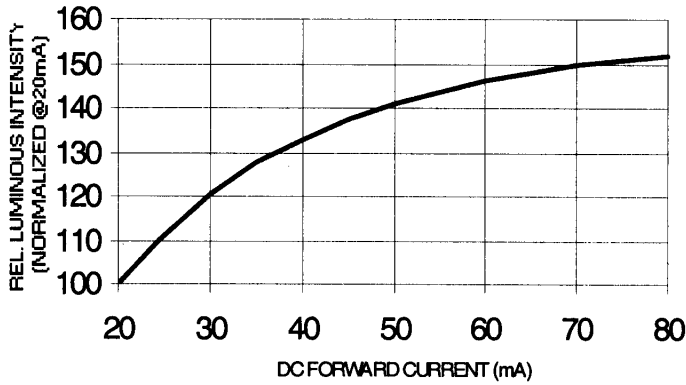

Fig. 7 Rel. Luminous Intensity vs. Peak Forward Current  
(300 us pulse width; 10 ms period)

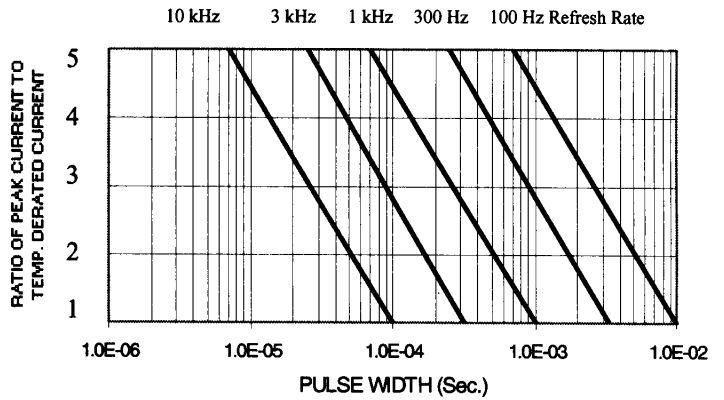

Fig. 8 Pulse Derating Curve

**DISCLAIMER**

FAIRCHILD SEMICONDUCTOR RESERVES THE RIGHT TO MAKE CHANGES WITHOUT FURTHER NOTICE TO ANY PRODUCTS HEREIN TO IMPROVE RELIABILITY, FUNCTION OR DESIGN. FAIRCHILD DOES NOT ASSUME ANY LIABILITY ARISING OUT OF THE APPLICATION OR USE OF ANY PRODUCT OR CIRCUIT DESCRIBED HEREIN; NEITHER DOES IT CONVEY ANY LICENSE UNDER ITS PATENT RIGHTS, NOR THE RIGHTS OF OTHERS.

**LIFE SUPPORT POLICY**

FAIRCHILD'S PRODUCTS ARE NOT AUTHORIZED FOR USE AS CRITICAL COMPONENTS IN LIFE SUPPORT DEVICES OR SYSTEMS WITHOUT THE EXPRESS WRITTEN APPROVAL OF THE PRESIDENT OF FAIRCHILD SEMICONDUCTOR CORPORATION. As used herein:

1. Life support devices or systems are devices or systems which, (a) are intended for surgical implant into the body, or (b) support or sustain life, and (c) whose failure to perform when properly used in accordance with instructions for use provided in the labeling, can be reasonably expected to result in a significant injury of the user.
2. A critical component in any component of a life support device or system whose failure to perform can be reasonably expected to cause the failure of the life support device or system, or to affect its safety or effectiveness.