

NOTES:

1. MATERIAL:
  - 1.1 HOUSING: PA9T
  - 1.2 DIELECTRIC: LCP
  - 1.3 SHELL: ZAMAK3
  - 1.4 CONTACT: BRASS
  - 1.5 BAFFLE: C5191-H
2. FINISH:
 

CONTACT:  
CONTACT:SEE ORDER INFORMATION.  
UNDERPLATING: 50~100u" NICKEL OVERALL  
SHELL:120u"~240u" MATTE TIN
3. ELECTRICAL DATA:
  - 3.1 IMPEDANCE: 100Ω
  - 3.2 FREQUENCY: DC to 10GHz
  - 3.3 RETURN LOSS: ≥30dB, 0.01GHz to 3GHz;  
≥25dB, 3GHz to 6GHz;  
≥20dB, 6GHz to 10GHz;
4. SPEC. PLS. REFER TO PS-92806-XXXX-XXX
5. PACKAGE PLS. REFER TO 92806-004CR-XX
6. PART NUMBER

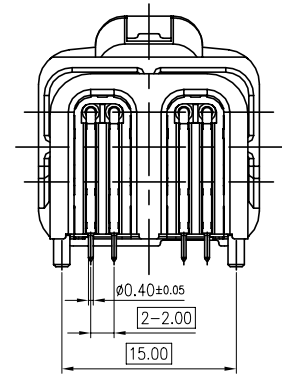
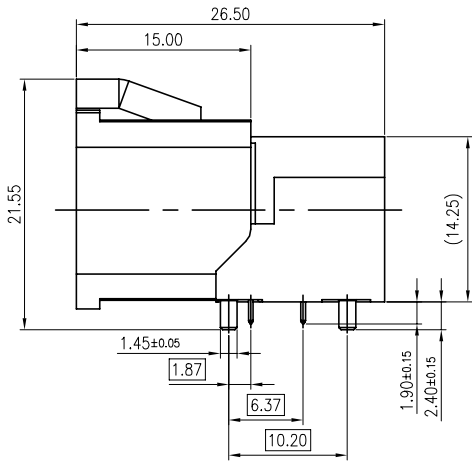
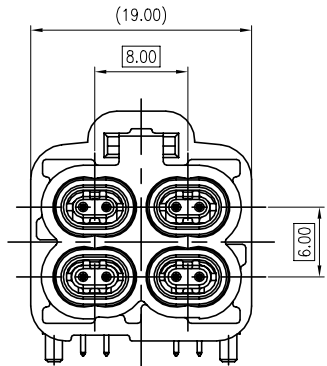

92806-004 X X- CAX  
 PORT X Coding:  
 X:REFERENCE ON  
 Page.2 TABLE  
 PACKING: PLATING:  
 0: TAPE & REEL 0: 6u"GOLD

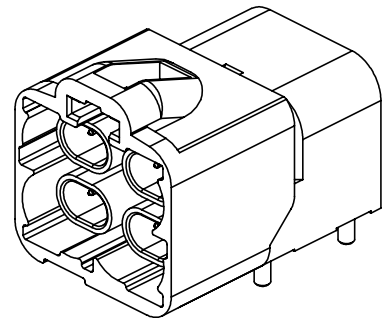
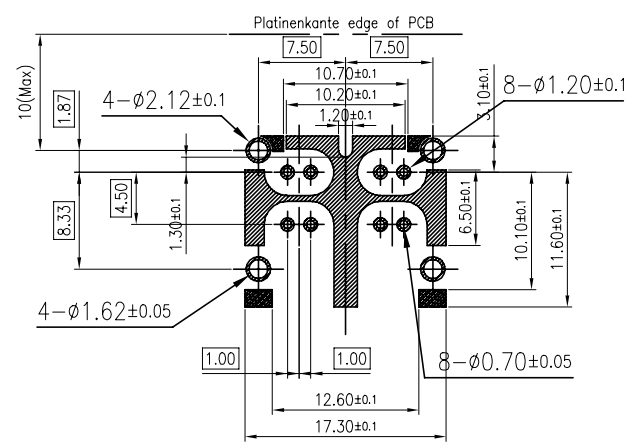

RECOMMENDED PCB LAYOUT  
 GENERAL TOLERANCE ±0.05

Solder area(13x)  
 Keepout area(4x)

QUALITY SYMBOLS	DRAWN BY	DATE	<b>ACES</b> ELECTRONICS	
MAJOR	TSO I CHIAO	21/04/26		
CRITICAL	CHECKED BY	DATE	TITLE	
GENERAL TOLERANCES (UNLESS SPECIFIED)	LEE Kuang En	21/04/26		
X. ±0.5	APPROVED BY	DATE		DWG NO.
.X ±0.25	CHEN Chi Chang	21/04/26		
.XX ±0.15	UNITS		SIZE	PART NO.
.XXX ±0.1	mm		A4	
ANGLES ±2°	SCALE	2 : 1	SHEET NO.	
			1 OF 2	
			REV	
			B	

A

B

C





D

E

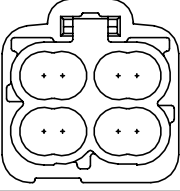
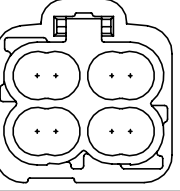
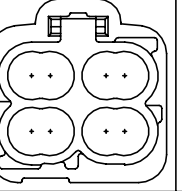
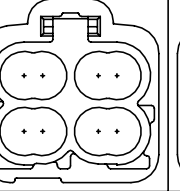
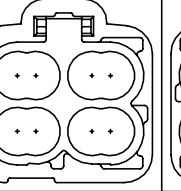
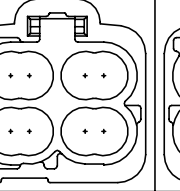
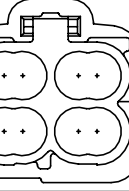
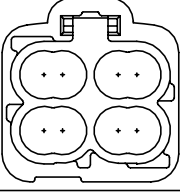
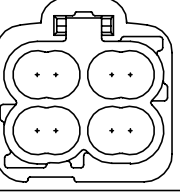
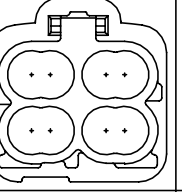
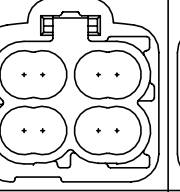
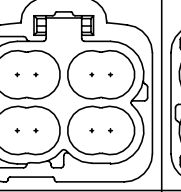
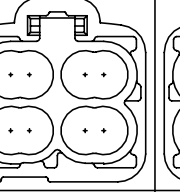
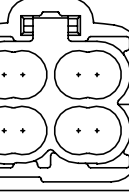
F

TABLE for Coding:

◎ CODING							
Coding	A KEY	B KEY	C KEY	D KEY	E KEY	F KEY	G KEY
Plug							
Color	Black	White	Blue	Bordeaux	Green	Brown	Grey
RAL	Sim. 9005	Sim. 9010	Sim. 5012	Sim. 4004	Sim. 6017	Sim. 8011	Sim. 7036
Coding	H KEY	J KEY	K KEY	L KEY	M KEY	O KEY	Z KEY
Plug							
Color	Violet	Beige	Curry	Carmin Red	Pastel Orange	Pastel Green	Waterblue
RAL	Sim. 3015	Sim. 1001	Sim. 1027	Sim. 6018	Sim. 2003	Sim. 6027	Sim. 5021

QUALITY SYMBOLS	DRAWN BY	DATE	<b>ACES</b> ELECTRONICS	
MAJOR 	TSO I CHIAO	21'04/26		
CRITICAL 	CHECKED BY	DATE	H-AMTD PCB PLUG RIGHT ANGLE QUAD	
GENERAL TOLERANCES (UNLESS SPECIFIED)	LEE Kuang En	21'04/26		
X. ±0.5	APPROVED BY	DATE		DWG NO.
.X ±0.25	CHEN Chi Chang	21'04/26	SIZE	92806-004XX-XXX
.XX ±0.15	UNITS		A4	PART NO.
.XXX ±0.1	mm	SCALE	2 : 1	SEE NOTES
ANGLES ±2°	SHEET NO.	REV	2 OF 2	
	B	B		

B

C

D

E

F