

## 36 V, 0.8% Accuracy, 300 mA, Voltage Regulator for Industrial Applications

NO.EA-377-190829

### OUTLINE

The R1513S is a CMOS-based voltage regulator (VR) featuring 300 mA output current and 36 V input voltage. Internally, the R1513S consists of a fold-back protection circuit, a short current protection circuit and a thermal shutdown circuit in addition to the basic regulator circuit.

The performance is specified for 25°C with  $\pm 0.8\%$  output voltage accuracy and for the  $-40^{\circ}\text{C}$  to  $125^{\circ}\text{C}$  temperature range with  $\pm 1.0\%$  output voltage accuracy. The operating temperature range is  $-40^{\circ}\text{C}$  to  $125^{\circ}\text{C}$  and the maximum input voltage is 36 V. All these features allow this device to become an ideal power source for equipments used under high-temperature conditions.

The R1513S is available in 1.2 V, 1.5 V, 1.8 V, 3.3 V, 3.4 V and 5.0 V fixed output voltage options. By using external divider resistors, the output voltage can be set over a 1.2 V to 18.0 V range.

The R1513S is offered in a 6-pin HSOP-6J high wattage package.

This is a high-reliability semiconductor device for industrial application (-Y) that has passed both the screening at high temperature and the reliability test with extended hours.

### FEATURES

- Input Voltage (Maximum Ratings) ..... 3.5 V to 36 V (50 V)
- Operating Temperature Range .....  $-40^{\circ}\text{C}$  to  $125^{\circ}\text{C}$
- Supply Current ..... Typ. 75  $\mu\text{A}$
- Standby Current ..... Typ. 0.1  $\mu\text{A}$
- Dropout Voltage ..... Typ. 0.32 V ( $I_{\text{OUT}} = 300 \text{ mA}$ ,  $V_{\text{OUT}} = 5.0 \text{ V}$ )
- Output Voltage Accuracy .....  $\pm 0.8\%$  ( $T_{\text{a}} = 25^{\circ}\text{C}$ )  
 $\pm 1.0\%$  ( $-40^{\circ}\text{C}$  to  $125^{\circ}\text{C}$ )
- Line Regulation ..... Typ. 0.01%/V ( $V_{\text{DD}} = V_{\text{OUT}} + 1 \text{ V}$  to 36 V)
- Package Type ..... HSOP-6J
- Output Voltage ..... 1.2 V / 1.5 V / 1.8 V / 3.3 V / 3.4 V / 5.0 V
- Short-current Protection Circuit ..... Current Limit Typ. 50 mA
- Fold-back Protection Circuit ..... Current Limit Typ. 450 mA
- Thermal Shutdown Circuit ..... Shutdown at Typ.  $160^{\circ}\text{C}$
- Ripple Rejection ..... Typ. 70 dB ( $f = 100 \text{ Hz}$ )
- Ceramic Capacitor Compatible ..... C1 = 1.0  $\mu\text{F}$  or more, C2 = 4.7  $\mu\text{F}$  or more

### APPLICATIONS

- Industrial equipment such as FAs and smart meters.
- Equipments used under high-temperature conditions such as surveillance camera and vending machine.
- Equipments accompanied by self-heating such as motor and lighting.

# R1513S-Y

NO.EA-377-190829

## BLOCK DIAGRAM

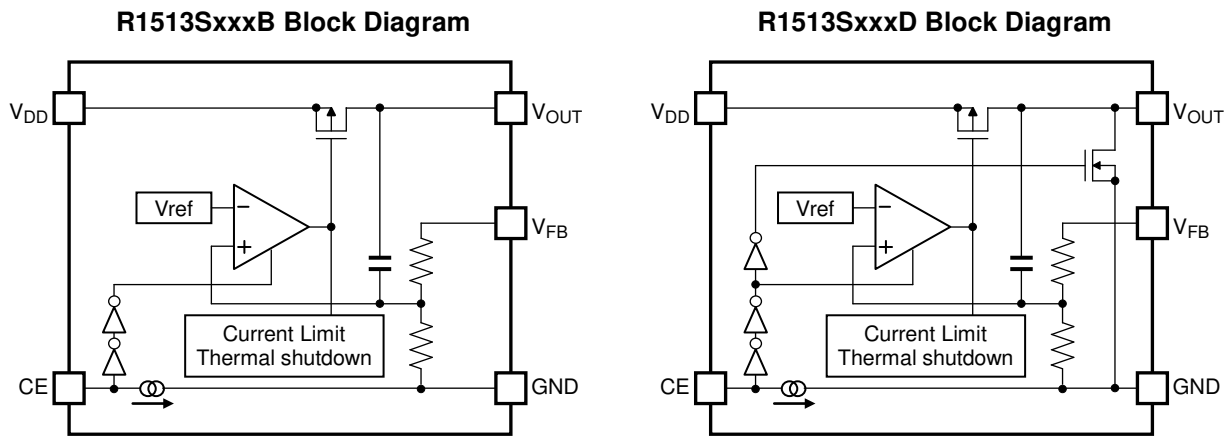

## SELECTION GUIDE

The set output voltage and the auto-discharge option<sup>\*1</sup> are user-selectable options.

### Selection Guide

Product Name	Package	Quantity per Reel	Pb Free	Halogen Free
R1513Sxx1*-E2-YE	HSOP-6J	1,000 pcs	Yes	Yes

xx: Specify the set output voltage ( $V_{SET}$ ) from below.

1.2 V (12) / 1.5 V (15) / 1.8 V (18) / 3.3 V (33) / 3.4 V (34) / 5.0 V (50)

\*: Specify the auto-discharge option.

B: Auto-discharge option not included

D: Auto-discharge option included

<sup>\*1</sup> Auto-discharge function quickly lowers the output voltage to 0 V, when the chip enable signal is switched from the active mode to the standby mode, by releasing the electrical charge accumulated in the external capacitor.

## PIN DESCRIPTION

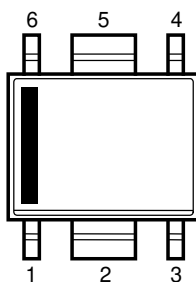

HSOP-6J Pin Configuration

### HSOP-6J Pin Description

Pin No.	Symbol	Description
1	$V_{OUT}$	Output Pin
2	GND <sup>*1</sup>	Ground Pin
3	$V_{FB}$	Feedback Pin
4	CE	Chip Enable Pin, Active-high
5	GND <sup>*1</sup>	Ground Pin
6	$V_{DD}$	Input Pin

<sup>\*1</sup> The GND pins must be wired together when they are mounted on board.

## ABSOLUTE MAXIMUM RATINGS

### Absolute Maximum Ratings

Symbol	Item		Rating	Unit
$V_{IN}$	Input Voltage		-0.3 to 50	V
$V_{IN}$	Peak Input Voltage <sup>*1</sup>		60	V
$V_{CE}$	CE Pin Input Voltage		-0.3 to 50	V
$V_{FB}$	$V_{FB}$ Pin Input Voltage		-0.3 to $V_{OUT} + 0.3 \leq 50$	V
$V_{OUT}$	Output Voltage		-0.3 to $V_{IN} + 0.3 \leq 50$	V
$P_D$	Power Dissipation <sup>*2</sup>	Ultra High Wattage Land Pattern	3400	mW
		Standard Land Pattern	2100	
$T_j$	Junction Temperature		-40 to 150	°C
$T_{stg}$	Storage Temperature Range		-55 to 150	°C

<sup>\*1</sup> Duration time = 200 ms

<sup>\*2</sup> Refer to *PACKAGE INFORMATION* for detailed informatoin.

### ABSOLUTE MAXIMUM RATINGS

Electronic and mechanical stress momentarily exceeded absolute maximum ratings may cause permanent damage and may degrade the life time and safety for both device and system using the device in the field. The functional operation at or over these absolute maximum ratings is not assured.

## RECOMMENDED OPERATING CONDITIONS

### Recommended Operating Conditions

Symbol	Item	Rating	Unit
$V_{IN}$	Input Voltage	3.5 to 36	V
$T_a$	Operating Temperature Range	-40 to 125	°C

### RECOMMENDED OPERATING CONDITIONS

All of electronic equipment should be designed that the mounted semiconductor devices operate within the recommended operating conditions. The semiconductor devices cannot operate normally over the recommended operating conditions, even if they are used over such conditions by momentary electronic noise or surge. And the semiconductor devices may receive serious damage when they continue to operate over the recommended operating conditions.

## ELECTRICAL CHARACTERISTICS

$C1 = 1.0 \mu\text{F}$ ,  $C2 = 4.7 \mu\text{F}$ ,  $V_{\text{OUT}} = V_{\text{FB}}$ ,  $V_{\text{SET}} = \text{Set Output Voltage}$ , unless otherwise noted.

The specifications surrounded by   are guaranteed by design engineering at  $-40^\circ\text{C} \leq T_a \leq 125^\circ\text{C}$ .

### R1513SxxxB/D Electrical Characteristics

( $T_a = 25^\circ\text{C}$ )

Symbol	Item	Conditions	Min.	Typ.	Max.	Unit
$I_{\text{SS}}$	Supply Current	$V_{\text{IN}} = 14 \text{ V}$ , $I_{\text{OUT}} = 0 \text{ mA}$		75	<span style="border: 1px solid black; padding: 0 2px;">110</span>	$\mu\text{A}$
$I_{\text{standby}}$	Standby Current	$V_{\text{IN}} = 36 \text{ V}$ , $V_{\text{CE}} = 0 \text{ V}$		0.1	<span style="border: 1px solid black; padding: 0 2px;">2.0</span>	$\mu\text{A}$
$V_{\text{OUT}}$	Output Voltage	$3.5 \text{ V} \leq V_{\text{SET}} + 1 \text{ V} \leq V_{\text{IN}} \leq 36 \text{ V}$ , $I_{\text{OUT}} = 1 \text{ mA}$	$V_{\text{SET}} \leq 1.8 \text{ V}$		<span style="border: 1px solid black; padding: 0 2px;">18</span>	mV
			$1.8 \text{ V} < V_{\text{SET}}$	<span style="border: 1px solid black; padding: 0 2px;">×0.99</span>	<span style="border: 1px solid black; padding: 0 2px;">×1.01</span>	V
		$3.5 \text{ V} \leq V_{\text{SET}} + 1 \text{ V} \leq V_{\text{IN}} \leq 14 \text{ V}$ , $1 \text{ mA} \leq I_{\text{OUT}} \leq 50 \text{ mA}$	$V_{\text{SET}} \leq 1.8 \text{ V}$		<span style="border: 1px solid black; padding: 0 2px;">18</span>	mV
			$1.8 \text{ V} < V_{\text{SET}}$	<span style="border: 1px solid black; padding: 0 2px;">×0.99</span>	<span style="border: 1px solid black; padding: 0 2px;">×1.01</span>	V
$\frac{\Delta V_{\text{OUT}}}{\Delta V_{\text{IN}}}$	Line Regulation	$3.5 \text{ V} \leq V_{\text{SET}} + 1 \text{ V} \leq V_{\text{IN}} \leq 36 \text{ V}$ $I_{\text{OUT}} = 1 \text{ mA}$	<span style="border: 1px solid black; padding: 0 2px;">-0.02</span>	0.01	<span style="border: 1px solid black; padding: 0 2px;">0.02</span>	%/V
$\frac{\Delta V_{\text{OUT}}}{\Delta I_{\text{OUT}}}$	Load Regulation	$3.5 \text{ V} \leq V_{\text{IN}} = V_{\text{SET}} + 1 \text{ V}$ , $1 \text{ mA} \leq I_{\text{OUT}} \leq 300 \text{ mA}$	$V_{\text{SET}} \leq 1.8 \text{ V}$		<span style="border: 1px solid black; padding: 0 2px;">5</span>	mV
			$V_{\text{SET}} = 3.3 \text{ V}$		<span style="border: 1px solid black; padding: 0 2px;">8</span>	
			$V_{\text{SET}} = 5.0 \text{ V}$		<span style="border: 1px solid black; padding: 0 2px;">12</span>	
$V_{\text{DIF}}$	Dropout Voltage	$I_{\text{OUT}} = 300 \text{ mA}$	$V_{\text{SET}} = 1.2 \text{ V}$		<span style="border: 1px solid black; padding: 0 2px;">2.30</span>	V
			$1.5 \text{ V} \leq V_{\text{SET}}$		<span style="border: 1px solid black; padding: 0 2px;">2.00</span>	
			$1.8 \text{ V} \leq V_{\text{SET}}$		<span style="border: 1px solid black; padding: 0 2px;">1.70</span>	
			$3.3 \text{ V} \leq V_{\text{SET}}$	0.39	<span style="border: 1px solid black; padding: 0 2px;">0.74</span>	
			$5.0 \text{ V} \leq V_{\text{SET}}$	0.32	<span style="border: 1px solid black; padding: 0 2px;">0.60</span>	
$I_{\text{LIM}}$	Output Current Limit	$V_{\text{IN}} = V_{\text{SET}} + 1.5 \text{ V}$	<span style="border: 1px solid black; padding: 0 2px;">300</span>	450		mA
$I_{\text{SC}}$	Short Current Limit	$V_{\text{OUT}} = 0 \text{ V}$	<span style="border: 1px solid black; padding: 0 2px;">40</span>	50		mA
$R_{\text{FB}}$	Feedback Resistance		<span style="border: 1px solid black; padding: 0 2px;">1.0</span>	2.4		M $\Omega$
$V_{\text{CEH}}$	CE Input Voltage "H"		<span style="border: 1px solid black; padding: 0 2px;">2.2</span>		<span style="border: 1px solid black; padding: 0 2px;">36</span>	V
$V_{\text{CEL}}$	CE Input Voltage "L"		<span style="border: 1px solid black; padding: 0 2px;">0</span>		<span style="border: 1px solid black; padding: 0 2px;">1.0</span>	V
$I_{\text{PD}}$	CE Pull-down Current	$V_{\text{CE}} = 5.0 \text{ V}$		0.2	<span style="border: 1px solid black; padding: 0 2px;">0.6</span>	$\mu\text{A}$
		$V_{\text{CE}} = 36 \text{ V}$		0.5	<span style="border: 1px solid black; padding: 0 2px;">1.3</span>	
$T_{\text{TSD}}$	Thermal Shutdown Temperature	Junction Temperature	<span style="border: 1px solid black; padding: 0 2px;">150</span>	160		$^\circ\text{C}$
$T_{\text{TSR}}$	Thermal Shutdown Released Temperature	Junction Temperature	<span style="border: 1px solid black; padding: 0 2px;">125</span>	135		$^\circ\text{C}$
$R_{\text{LOW}}$	Low Output Nch Tr. ON Resistance (R1513SxxxD)	$V_{\text{IN}} = 14.0 \text{ V}$ , $V_{\text{CE}} = 0 \text{ V}$	<span style="border: 1px solid black; padding: 0 2px;">1.5</span>	3.2	<span style="border: 1px solid black; padding: 0 2px;">6.7</span>	k $\Omega$

All test items listed under *Electrical Characteristics* are done under the pulse load condition ( $T_j \approx T_a = 25^\circ\text{C}$ ).

---

**R1513S-Y**

---

NO.EA-377-190829

The specifications surrounded by  $\square$  are guaranteed by design engineering at  $-40^{\circ}\text{C} \leq T_a \leq 125^{\circ}\text{C}$ .

**Product-specific Electrical Characteristics**

(Ta = 25°C)

Product Name	V <sub>OUT</sub> [V]			$\Delta V_{\text{OUT}}/\Delta I_{\text{OUT}}$ [mV]		V <sub>DIF</sub> [V]	
	MIN.	TYP.	MAX.	MIN.	MAX.	TYP.	MAX.
R1513S121x	$\square 1.182$	1.200	$\square 1.218$	$\square -5$	$\square 5$		$\square 2.30$
R1513S151x	$\square 1.482$	1.500	$\square 1.518$	$\square -5$	$\square 5$		$\square 2.00$
R1513S181x	$\square 1.782$	1.800	$\square 1.818$	$\square -5$	$\square 5$		$\square 1.70$
R1513S331x	$\square 3.267$	3.300	$\square 3.333$	$\square -8$	$\square 8$	0.39	$\square 0.74$
R1513S341x	$\square 3.366$	3.400	$\square 3.434$	$\square -8$	$\square 8$	0.39	$\square 0.74$
R1513S501x	$\square 4.950$	5.000	$\square 5.050$	$\square -12$	$\square 12$	0.32	$\square 0.60$

## TYPICAL APPLICATION

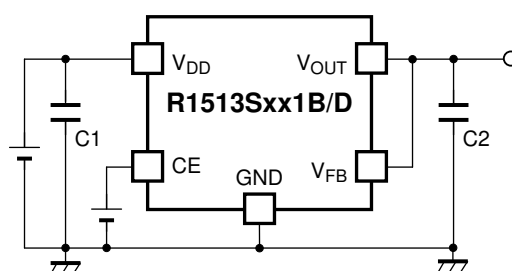

R1513S Typical Application

### External Components List

Symbol	Description
C1	1.0 $\mu$ F, Ceramic Capacitor
C2	4.7 $\mu$ F, Ceramic Capacitor

## TECHNICAL NOTES

### Phase Compensation

Phase compensation is provided to secure stable operation even when the load current is varied. For this purpose, use a 4.7  $\mu$ F or more output capacitor (C2) with good frequency characteristics and proper ESR (Equivalent Series Resistance). Connect a 1.0  $\mu$ F or more input capacitor (C1) between the V<sub>DD</sub> pin and the GND pin as close as possible to the pins.

In case of using a tantalum type capacitor with a large ESR, the output might become unstable. Evaluate your circuit including consideration of frequency characteristics.

Depending on the capacitor size, manufacturer, and part number, the bias characteristics and the temperature characteristics vary.

### PCB Layout

Ensure the V<sub>DD</sub> and GND lines are sufficiently robust. If their impedance is too high, noise pickup or unstable operation may result. No. 2 pin and No.5 pin must be wired together when mounting on board. Connect a capacitor with a suitable value between the V<sub>DD</sub> and GND pins, and as close as possible to the pins. The load regulation can be improved by short-circuiting V<sub>OUT</sub> and V<sub>FB</sub> close to the load device.

### Thermal Shutdown Function

Thermal shutdown function detects overheating of the regulator and stops the regulator operation to protect the device from damage. Thermal shutdown circuit stops the regulator operation if the junction temperature becomes higher than 160°C (Typ.) and restarts the regulator operation if the junction temperature drops below 135°C (Typ.). The regulator repeats turning on and off and creates pulse waveform until the cause of the overheating is removed.

### Adjustable Output Voltage Setting

Output voltage can be adjusted by using the external divider resistors (R1, R2). By using the following equation, the output voltage ( $V_{OUT}$ ) can be determined. The voltage which is fixed inside the IC is described as  $V_{FB}$ .

$$V_{OUT} = V_{FB} \times ((R1 + R2) / R2)$$

Recommended Output Voltage Range:  $1.2 \text{ V} \leq V_{OUT} \leq 18 \text{ V}$

$$V_{FB} = V_{SET}$$

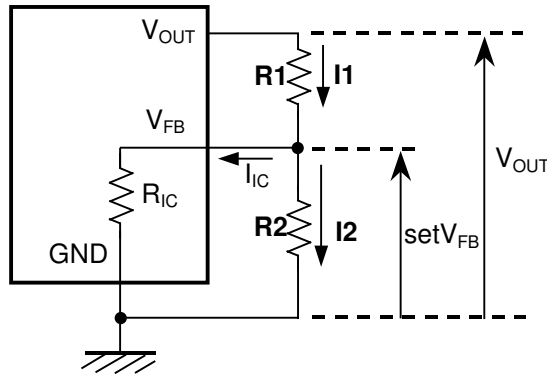

**Output Voltage Adjustment Using External Divider Resistors (R1, R2)**

The minimum resistance value for a resistor ( $R_{IC}$ ) is 1 M $\Omega$  ( $T_a = 25^\circ\text{C}$ , guaranteed by design). For better accuracy, setting  $R1 \ll R_{IC}$  reduces errors. The resistance value for a resistor (R2) should be set to 33 k $\Omega$  or lower. If the resistance values set for R1 and R2 are larger, the impedance of the  $V_{FB}$  pin becomes larger.

$R_{IC}$  could be affected by temperature; therefore, evaluate the circuit taking the actual conditions of use into account when deciding the resistance values for R1 and R2.



## TYPICAL APPLICATION FOR IC CHIP BREAKDOWN PREVENTION

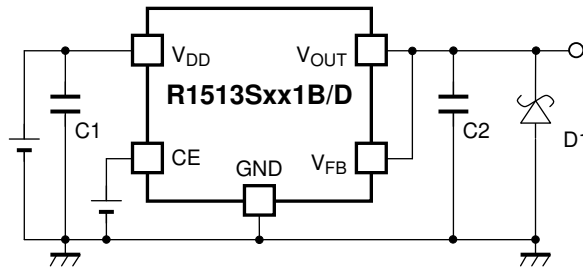

R1513S Typical Application for IC Chip Breakdown Prevention

When a sudden surge of electrical current travels along the  $V_{OUT}$  pin and GND due to a short-circuit, electrical resonance of a circuit involving an output capacitor ( $C_2$ ) and a short circuit inductor generates a negative voltage and may damage the device or the load devices. Connecting a schottky diode ( $D_1$ ) between the  $V_{OUT}$  pin and GND has the effect of preventing damage to them.

## PIN EQUIVALENT CIRCUIT DIAGRAMS

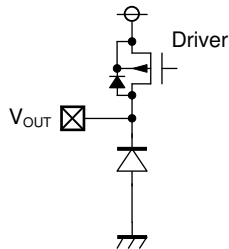

$V_{OUT}$  Pin Equivalent Circuit Diagrams

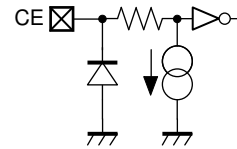

CE Pin Equivalent Circuit Diagrams

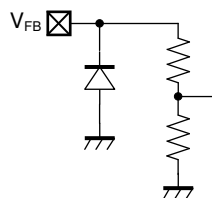

$V_{FB}$  Pin Equivalent Circuit Diagrams

**PACKAGE INFORMATION**

**POWER DISSIPATION (HSOP-6J)**

The power dissipation of the package is dependent on PCB material, layout, and environmental conditions. The following conditions are used in this measurement.

**Measurement Conditions**

	<b>Ultra-high Wattage Land Pattern</b>	<b>Standard Land Pattern</b>
Environment	Mounting on Board (Wind Velocity = 0 m/s)	Mounting on Board (Wind Velocity = 0 m/s)
Board Material	Glass Cloth Epoxy Plastic (Four-layer Board)	Glass Cloth Epoxy Plastic (Double-sided Board)
Board Dimensions	76.2 mm × 114.3 mm × 0.8 mm	50 mm × 50 mm × 1.6 mm
Copper Ratio	96%	50%
Through-holes	φ 0.3 mm × 28 pcs	φ 0.5 mm × 24 pcs

**Measurement Result**

(Ta = 25°C, Tjmax = 150°C)

	<b>Ultra-high Wattage Land Pattern</b>	<b>Standard Land Pattern</b>	<b>Free Air</b>
Power Dissipation	3400 mW	2100 mW	675 mW
Thermal Resistance	37°C/W	59°C/W	185°C/W

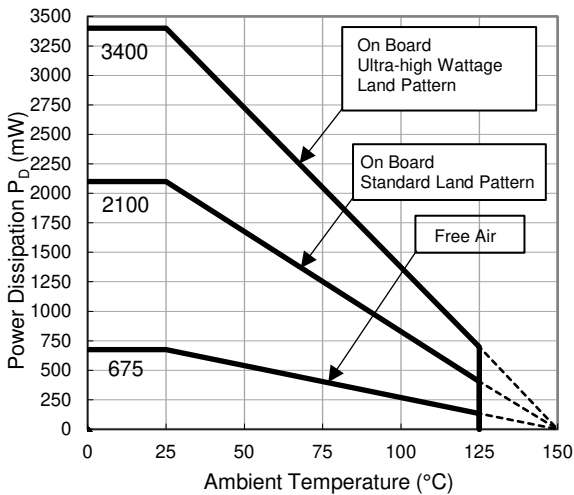

**Power Dissipation vs. Ambient Temperature**

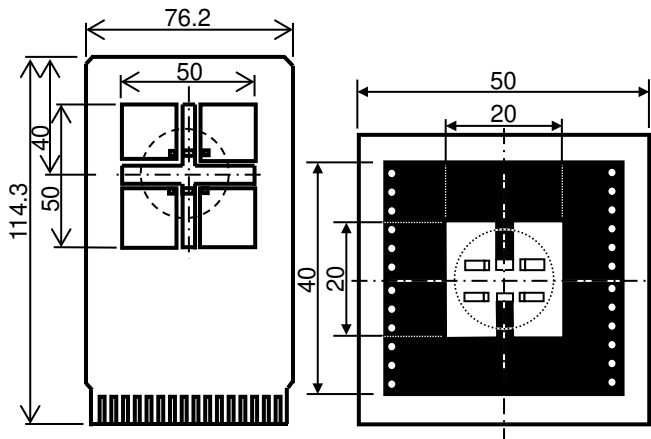

○ IC Mount Area (mm)

**Measurement Board Pattern**

**PACKAGE DIMENSIONS (HSOP-6J)**

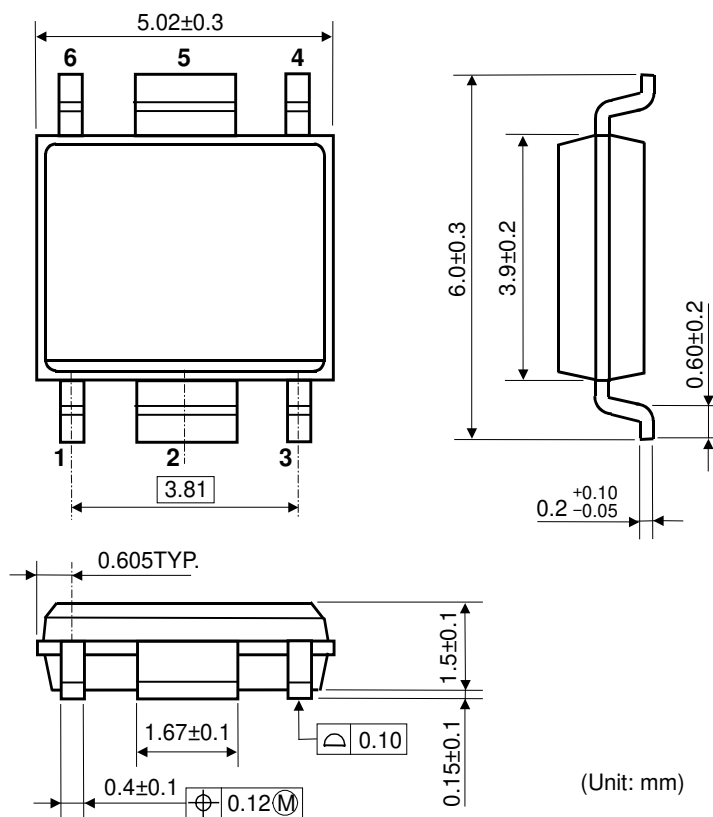

**HSOP-6J Package Dimensions**

**MARK SPECIFICATION (HSOP-6J)**

- ①②③④: Product Code ... **Refer to MARK SPECIFICATION TABLE (HSOP-6J).**
- ⑤⑥: Lot Number ... Alphanumeric Serial Number

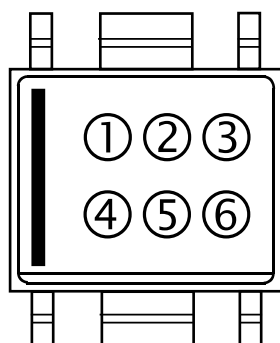

**HSOP-6J Mark Specification**

---

**R1513S-Y**

---

NO.EA-377-190829

**MARK SPECIFICATION TABLE (HSOP-6J)****Mark Specification Table**

<b>Product Name</b>	<b>①②③④</b>
R1513S121B	Z 1 2 B
R1513S151B	Z 1 5 B
R1513S181B	Z 1 8 B
R1513S331B	Z 3 3 B
R1513S341B	Z 3 4 B
R1513S501B	Z 5 0 B
R1513S121D	Z 1 2 D
R1513S151D	Z 1 5 D
R1513S181D	Z 1 8 D
R1513S331D	Z 3 3 D
R1513S341D	Z 3 4 D
R1513S501D	Z 5 0 D

## TYPICAL CHARACTERISTICS

Note: Typical Characteristics are intended to be used as reference data; they are not guaranteed.

### 1) Output Voltage vs. Output Current (Ta = 25°C)

R1513S121B/D

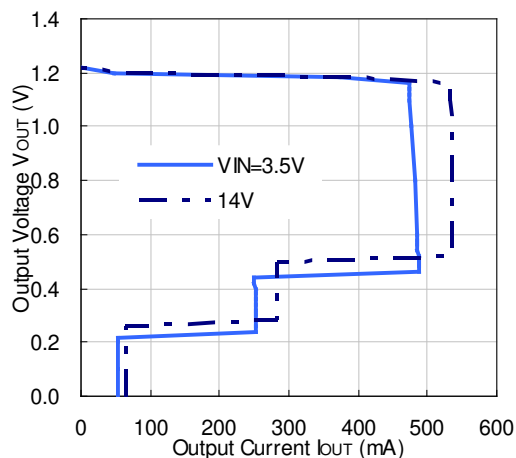

R1513S331B/D

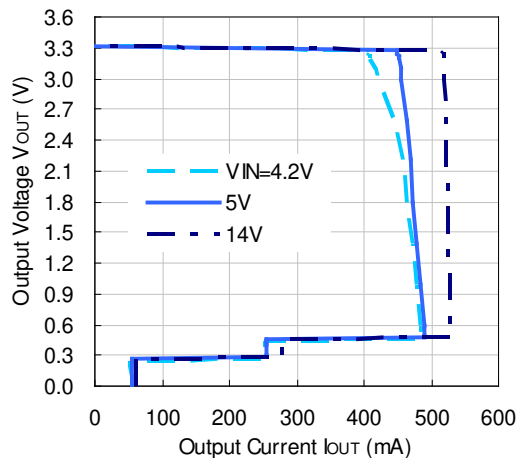

R1513S501B/D

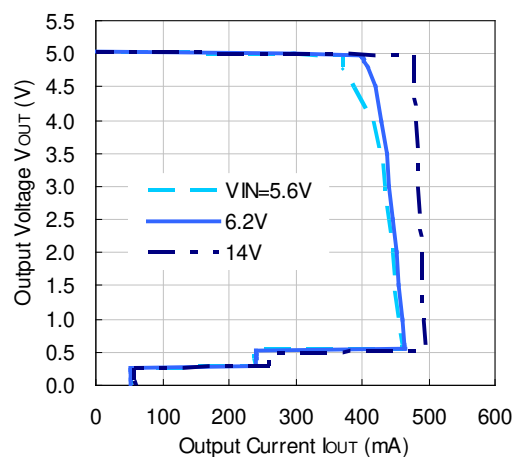

### 2) Output Voltage vs. Input Voltage (Ta = 25°C)

R1513S121B/D

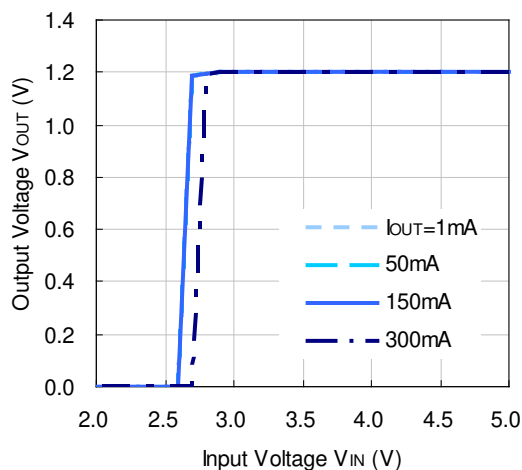

R1513S331B/D

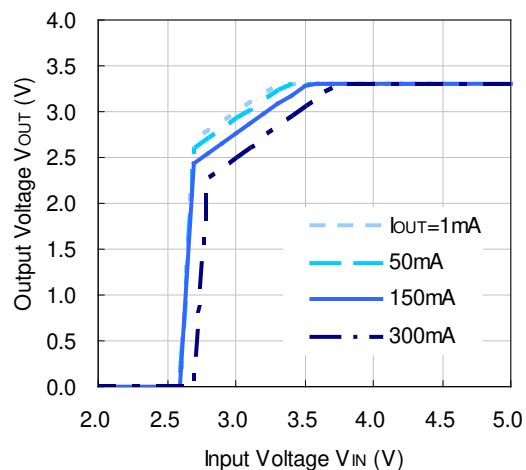

**R1513S501B/D**

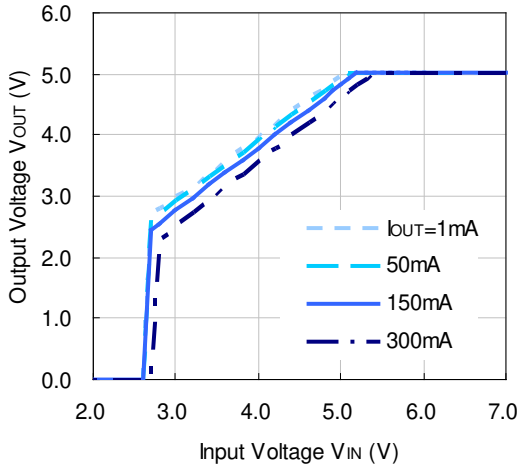

**3) Supply Current vs. Input Voltage (Ta = 25°C)**

**R1513S121B/D**

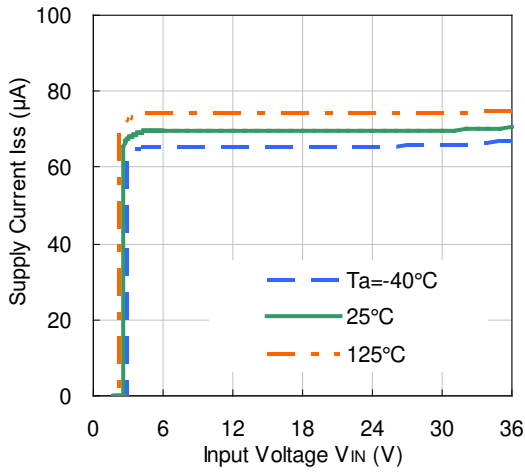

**R1513S331B/D**

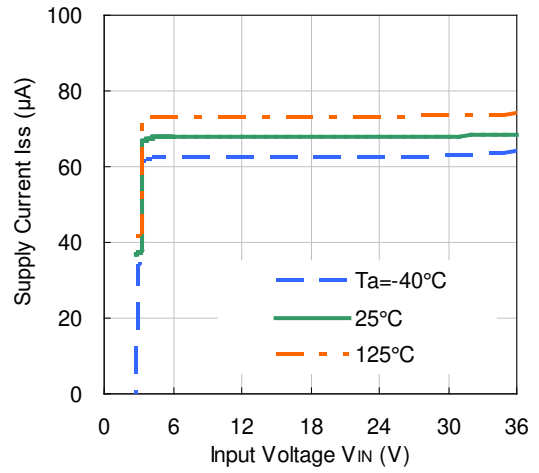

**R1513S501B/D**

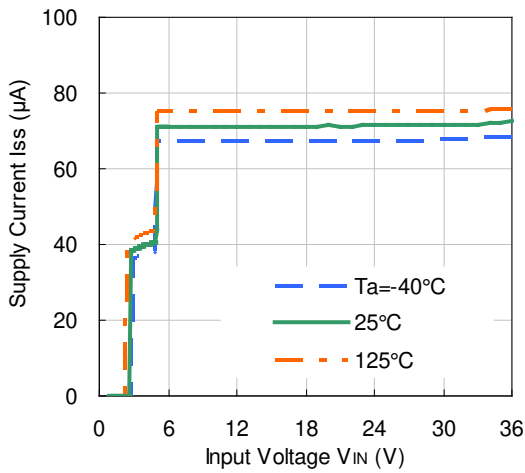

**4) GND Pin Current vs. Output Current (Ta = 25°C)**

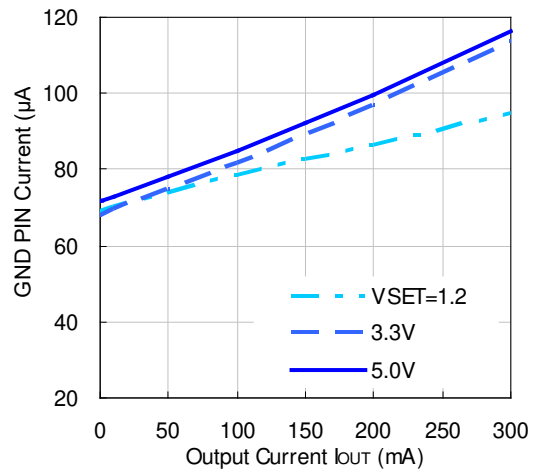

5) Output Voltage vs. Ambient Temperature

R1513S121B/D

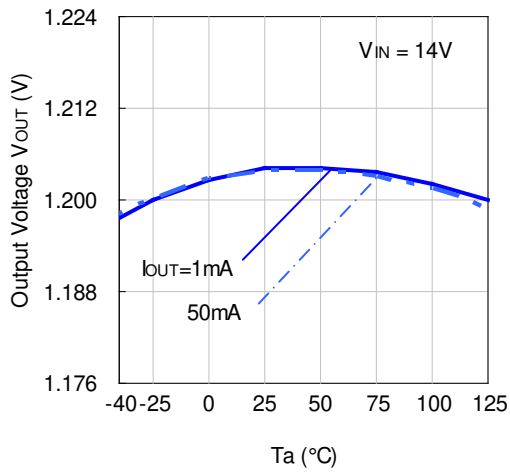

R1513S331B/D

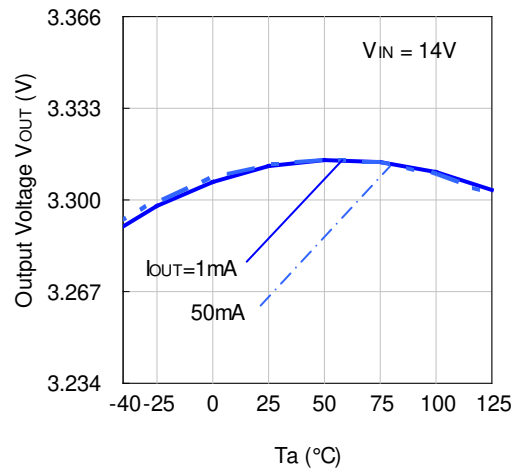

R1513S501B/D

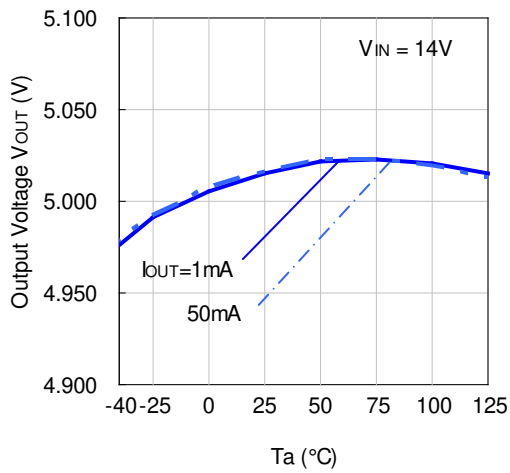

R1513S121B/D  
(Output Voltage Adjusted to 17.2 V)

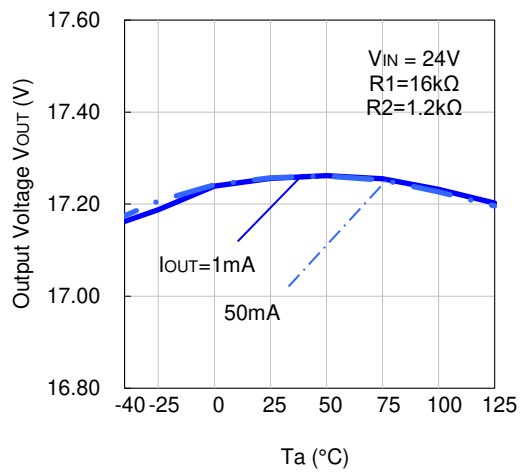

6) Dropout Voltage vs. Output Current

R1513S121B/D

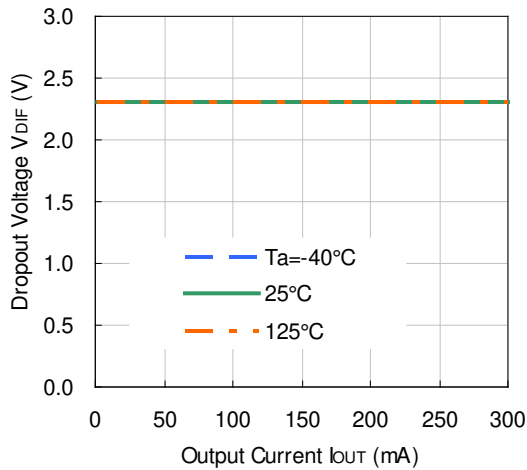

R1513S331B/D

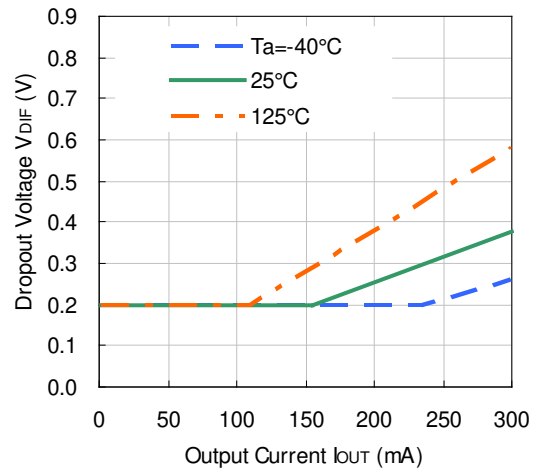

**R1513S501B/D**

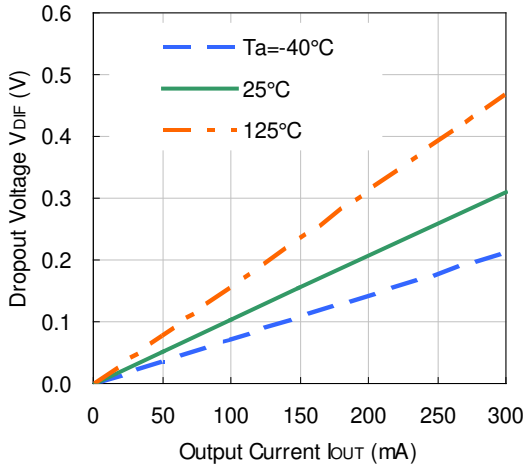

**7) Dropout Voltage vs. Output Voltage ( $T_a = 25^\circ\text{C}$ )**

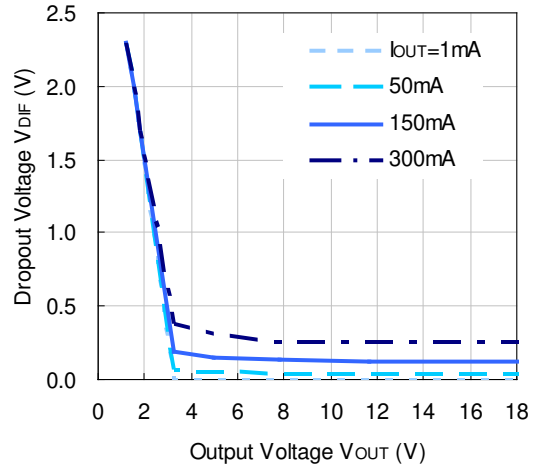

**8) Ripple Rejection vs. Input Voltage ( $T_a = 25^\circ\text{C}$ , Ripple = 0.5 Vpp)**

**R1513S121B/D ( $I_{OUT} = 1\text{ mA}$ )**

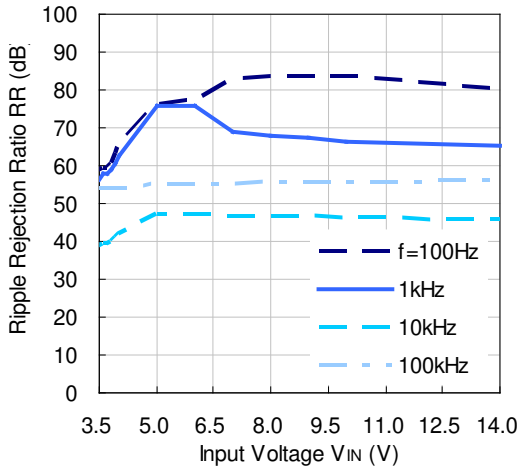

**R1513S121B/D ( $I_{OUT} = 50\text{ mA}$ )**

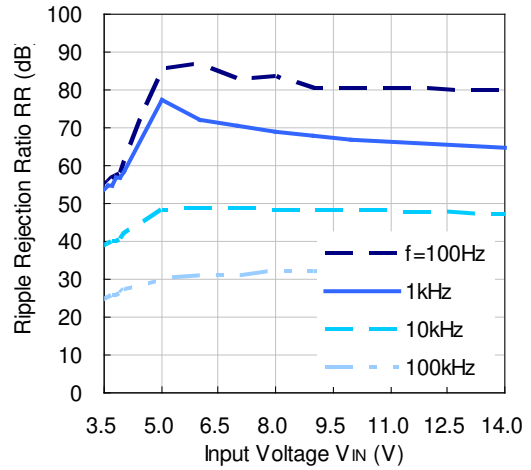

**R1513S331B/D ( $I_{OUT} = 1\text{ mA}$ )**

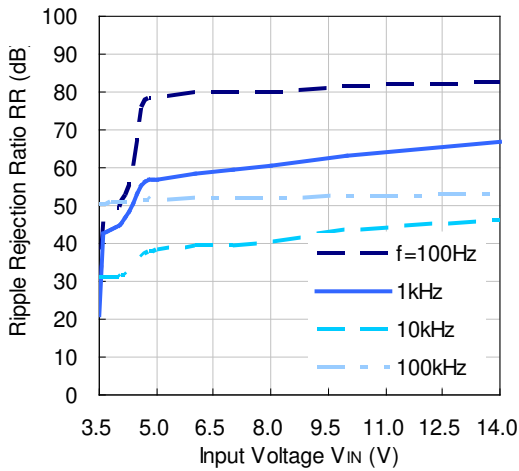

**R1513S331B/D ( $I_{OUT} = 50\text{ mA}$ )**

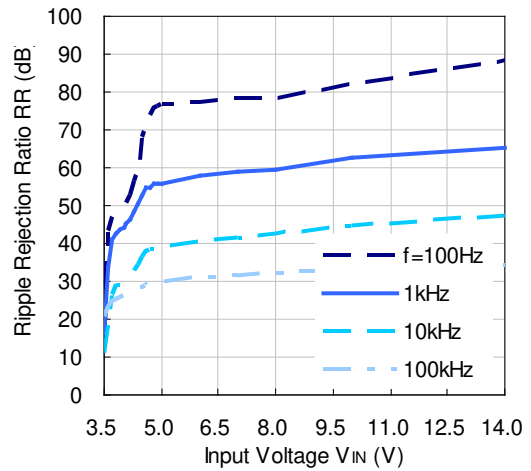



R1513S501B/D ( $I_{OUT} = 1\text{ mA}$ )

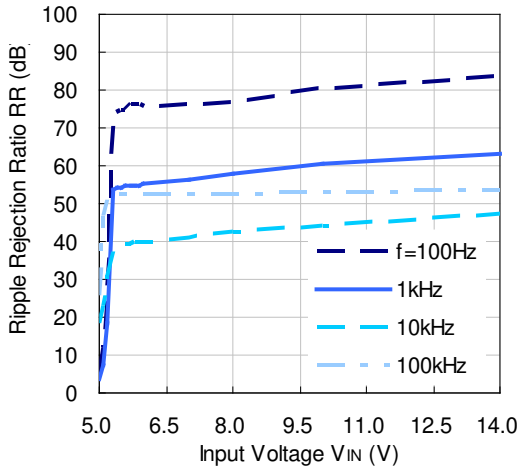

R1513S501B/D ( $I_{OUT} = 50\text{ mA}$ )

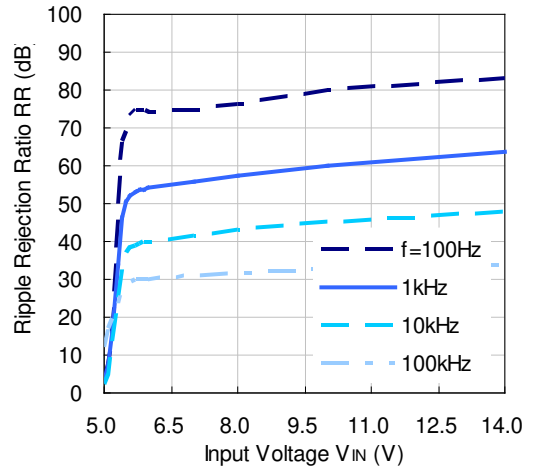

9) Ripple Rejection vs. Frequency ( $T_a = 25^\circ\text{C}$ , Ripple = 0.5 Vpp)

R1513S121B/D

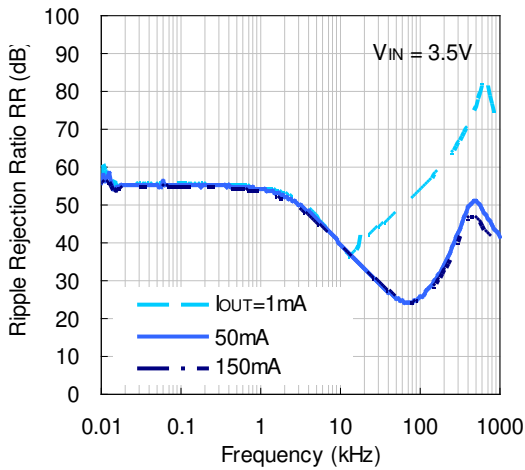

R1513S331B/D

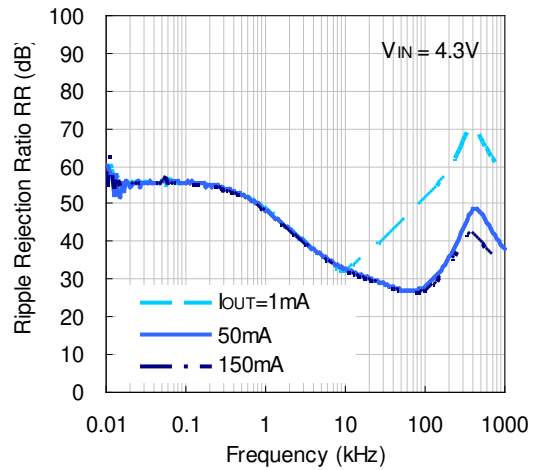

R1513S501B/D

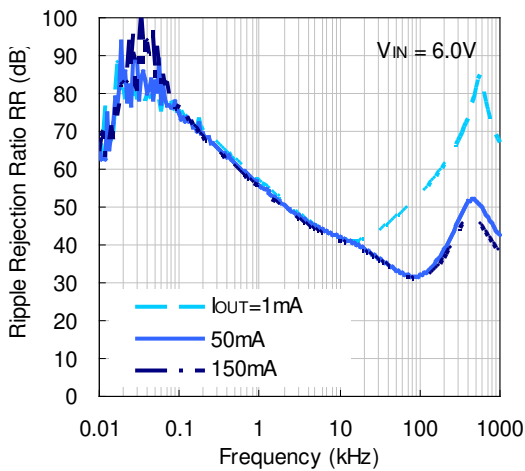

# R1513S-Y

NO.EA-377-190829

## 10) Input Transient Response ( $T_a = 25^\circ\text{C}$ , $C_2 = 4.7\mu\text{F}$ )

**R1513S121B/D**

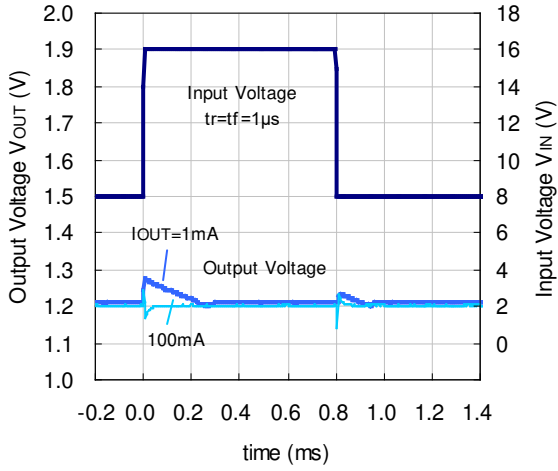

**R1513S331B/D**

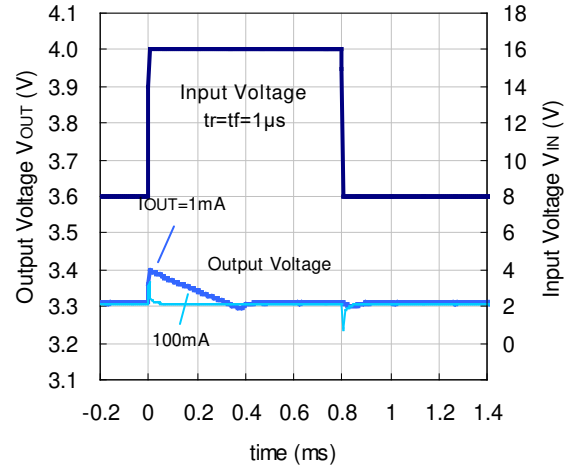

**R1513S501B/D**

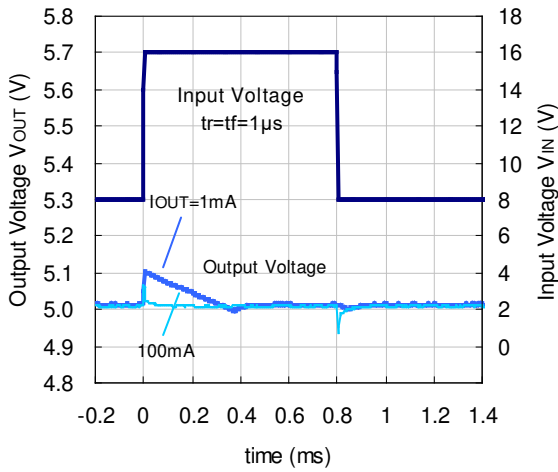

## 11) Cranking ( $T_a = -18^\circ\text{C}$ )

**R1513S501B/D**

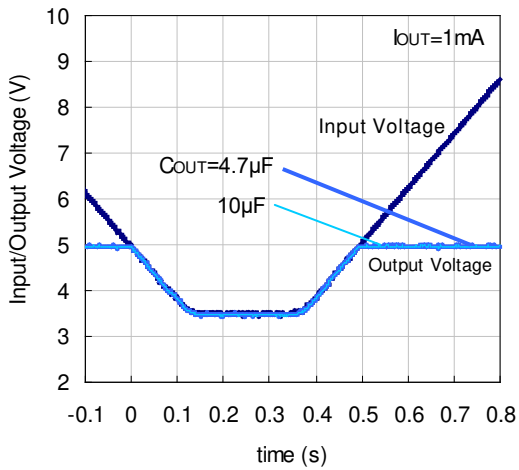

## 12) Load Dumping ( $T_a = 25^\circ\text{C}$ , $C_2 = 4.7\mu\text{F}$ )

**R1513S121B/D**

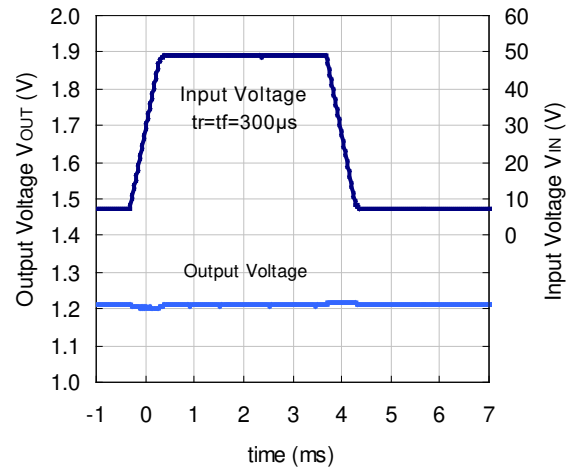

R1513S331B/D

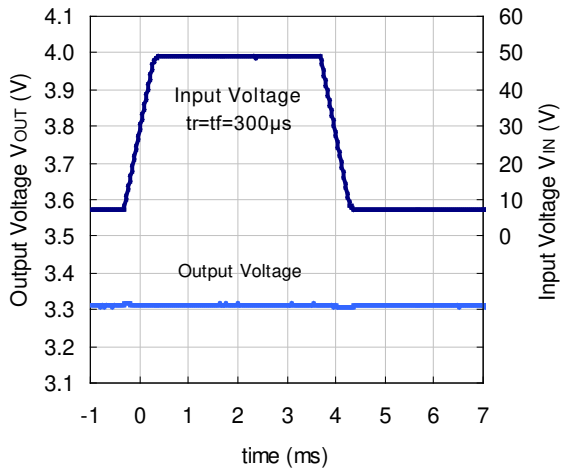

R1513S501B/D

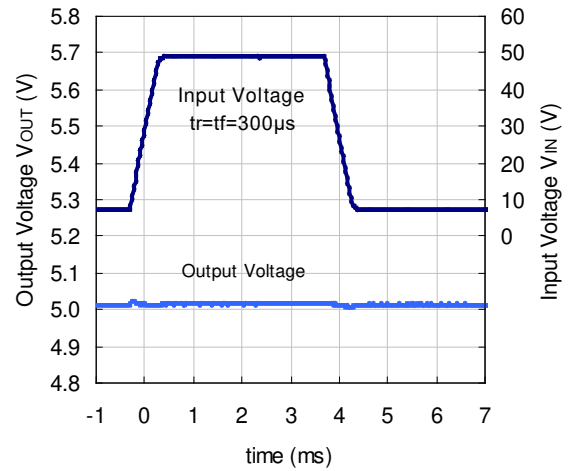

13) Load Transient Response ( $T_a = 25^\circ C$ )

R1513S121B/D

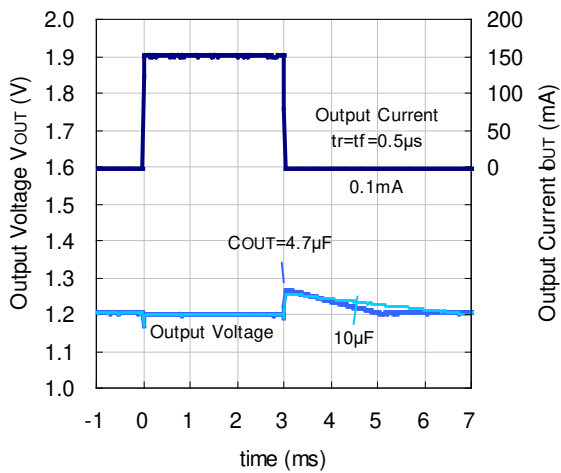

R1513S331B/D

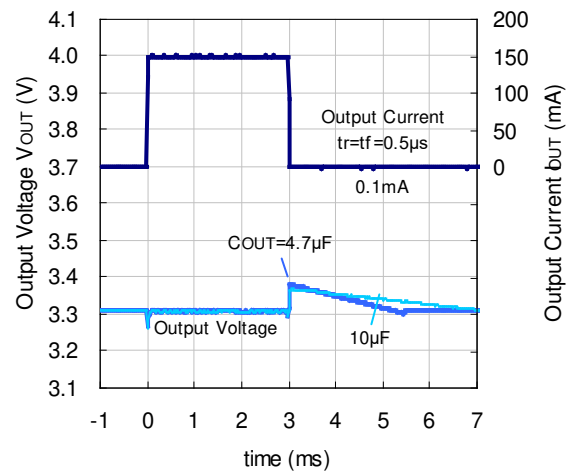

R1513S501B/D

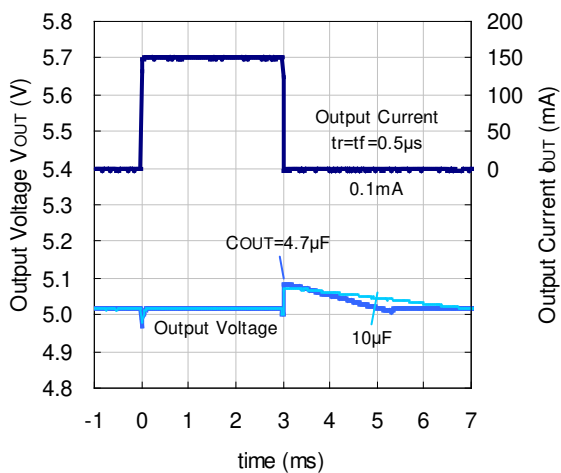

# R1513S-Y

NO.EA-377-190829

## 14) CE Transient Response ( $T_a = 25^\circ\text{C}$ )

### R1513S121B/D ( $V_{IN} = 3.5\text{ V}$ )

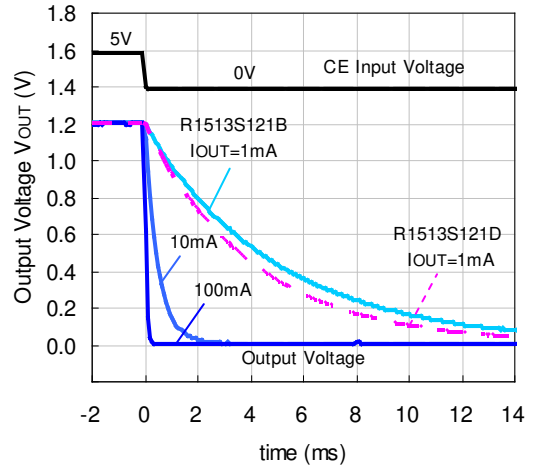
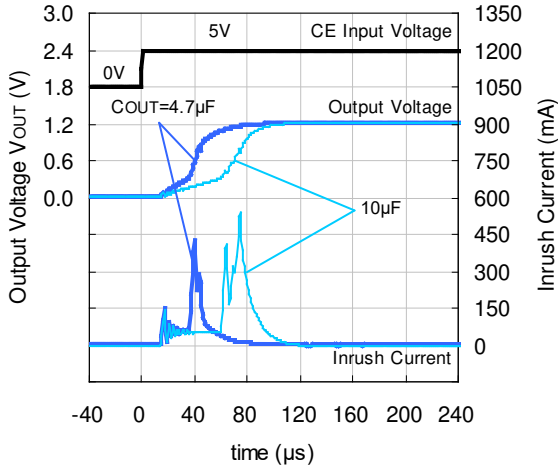

### R1513S331B/D ( $V_{IN} = 4.3\text{ V}$ )

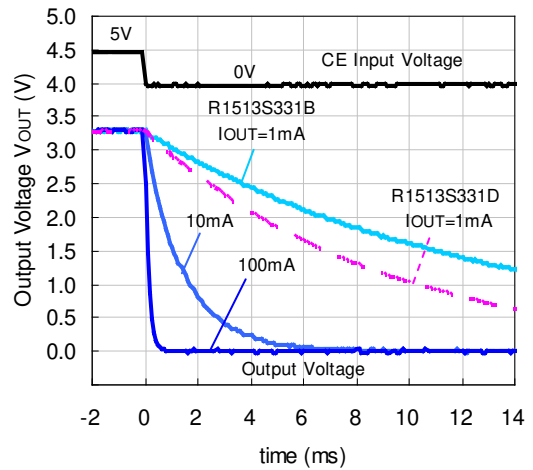
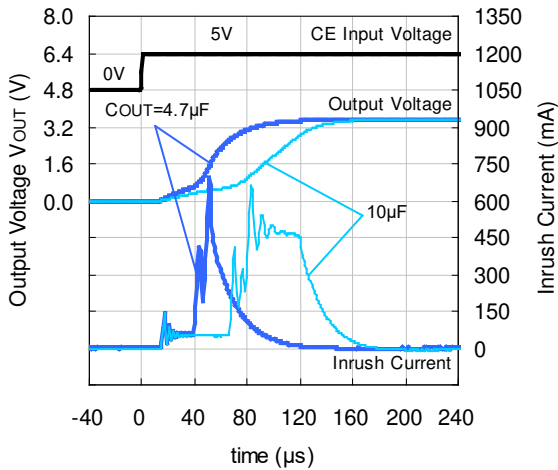

### R1513S501B/D ( $V_{IN} = 6.0\text{ V}$ )

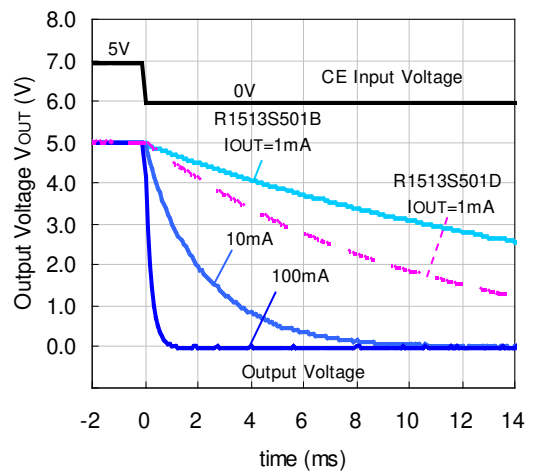
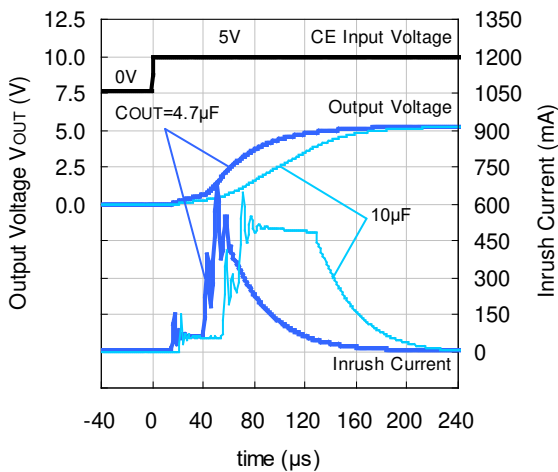

15) Power-on Transient Response ( $T_a = 25^\circ\text{C}$ ,  $V_{CE} = 5\text{ V}$ )

R1513S121B/D

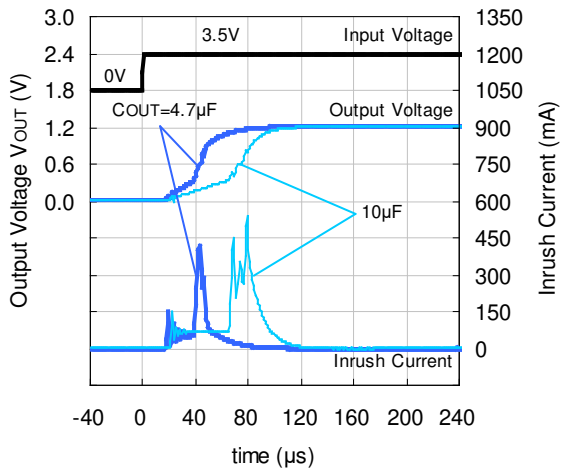

R1513S331B/D

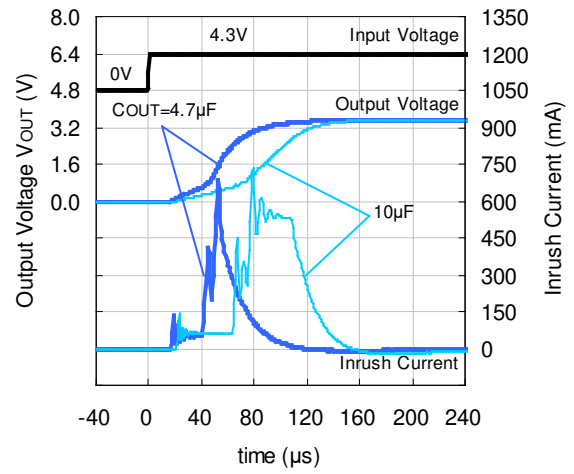

R1513S501B/D

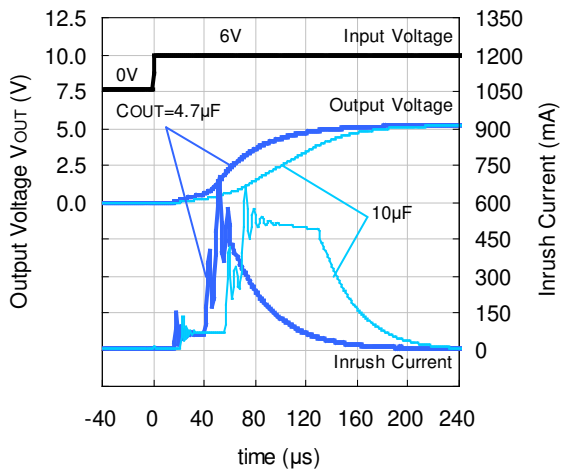

16) Thermal Shutdown

R1513S501B/D

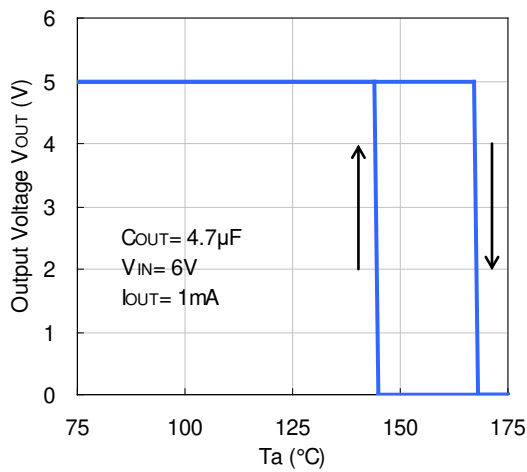

17) CE Pin Current vs. CE Pin Voltage ( $T_a = 25^\circ\text{C}$ )

R1513Sxx1B/D

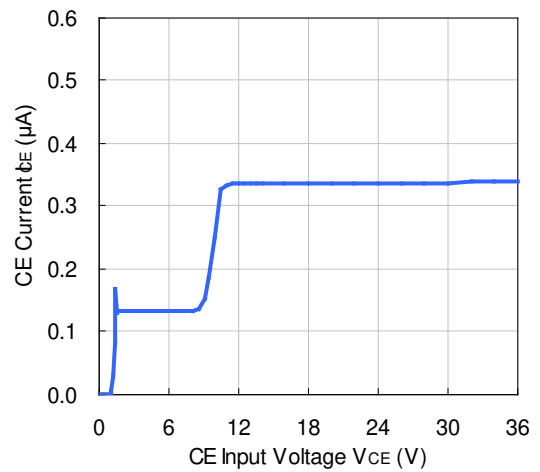

# R1513S-Y

NO.EA-377-190829

## Equivalent Series Resistance (ESR) vs. Output Current

It is recommended that a ceramic type capacitor be used for this device. However, other types of capacitors having lower ESR can also be used. The relation between the output current ( $I_{OUT}$ ) and the ESR of output capacitor is shown below.

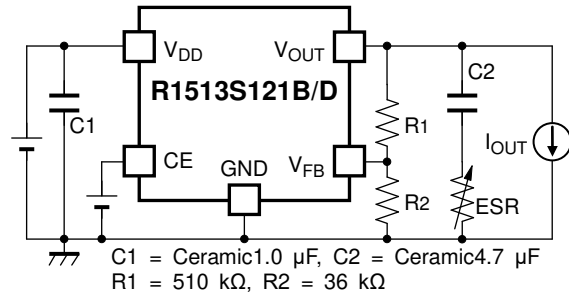
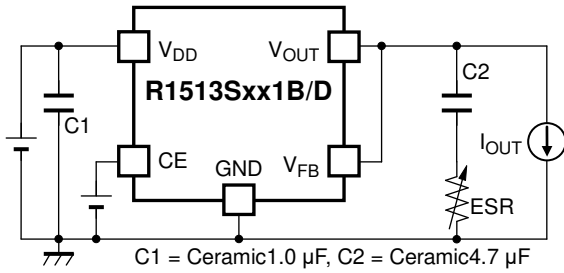

### Measurement Conditions

Frequency Band: 10 Hz to 2 MHz

Ambient Temperature: -40°C to 125°C

Hatched Area: Noise level below 40  $\mu$ V (average)

Capacitor: C1 = 1.0  $\mu$ F Ceramic Capacitor, C2 = 4.7  $\mu$ F Ceramic Capacitor (CGA4J3X7R1C475K125AB)

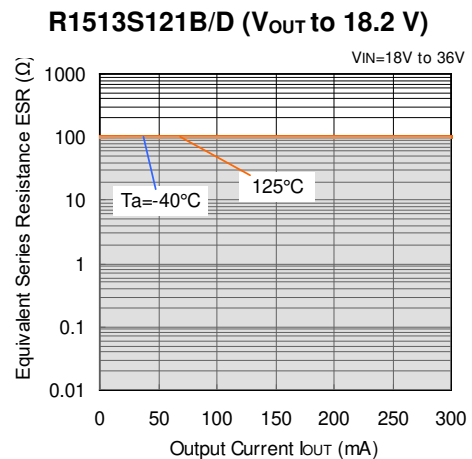
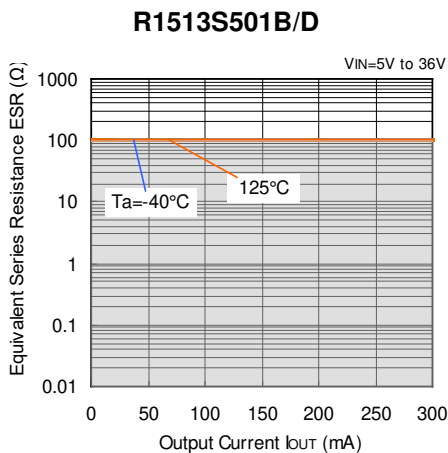
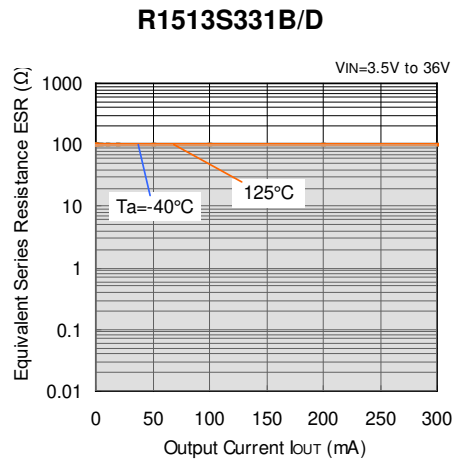
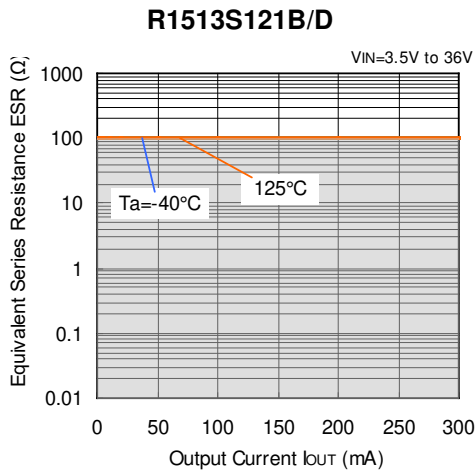



1. The products and the product specifications described in this document are subject to change or discontinuation of production without notice for reasons such as improvement. Therefore, before deciding to use the products, please refer to our sales representatives for the latest information thereon.
2. The materials in this document may not be copied or otherwise reproduced in whole or in part without prior written consent of our company.
3. Please be sure to take any necessary formalities under relevant laws or regulations before exporting or otherwise taking out of your country the products or the technical information described herein.
4. The technical information described in this document shows typical characteristics of and example application circuits for the products. The release of such information is not to be construed as a warranty of or a grant of license under our company's or any third party's intellectual property rights or any other rights.
5. The products listed in this document are intended and designed for use as general electronic components in standard applications (office equipment, telecommunication equipment, measuring instruments, consumer electronic products, amusement equipment etc.). Those customers intending to use a product in an application requiring extreme quality and reliability, for example, in a highly specific application where the failure or misoperation of the product could result in human injury or death (aircraft, spacevehicle, nuclear reactor control system, traffic control system, automotive and transportation equipment, combustion equipment, safety devices, life support system etc.) should first contact us.
6. We are making our continuous effort to improve the quality and reliability of our products, but semiconductor products are likely to fail with certain probability. In order to prevent any injury to persons or damages to property resulting from such failure, customers should be careful enough to incorporate safety measures in their design, such as redundancy feature, fire containment feature and fail-safe feature. We do not assume any liability or responsibility for any loss or damage arising from misuse or inappropriate use of the products.
7. Anti-radiation design is not implemented in the products described in this document.
8. The X-ray exposure can influence functions and characteristics of the products. Confirm the product functions and characteristics in the evaluation stage.
9. WLCSP products should be used in light shielded environments. The light exposure can influence functions and characteristics of the products under operation or storage.
10. There can be variation in the marking when different AOI (Automated Optical Inspection) equipment is used. In the case of recognizing the marking characteristic with AOI, please contact our sales or our distributor before attempting to use AOI.
11. Please contact our sales representatives should you have any questions or comments concerning the products or the technical information.



**Nisshinbo Micro Devices Inc.**

**Official website**

<https://www.nisshinbo-microdevices.co.jp/en/>

**Purchase information**

<https://www.nisshinbo-microdevices.co.jp/en/buy/>

