

## 2A, Low Input Voltage, Ultra-Low Dropout Linear Regulator with Enable

### General Description

The RT9048 is a high performance positive voltage regulator designed for use in applications requiring ultra low input voltage and ultra-low dropout voltage at up to 2A. The feature of ultra-low dropout voltage is ideal for the application where output voltage is very close to input voltage. The input voltage can be as low as 1.4V and the output voltage is adjustable by an external resistive divider as low as 0.5V. The RT9048 provides an excellent output voltage regulation over variations in line, load and temperature. Over-current and over-temperature protection functions are provided. Additionally, an enable pin is designed to further reduce power consumption while shutdown and the shutdown current is as low as 1.5µA.

The RT9048 is available in the SOP-8 (Exposed Pad) package.

### Ordering Information

RT9048	□□
	└─ Package Type
	SP : SOP-8 (Exposed Pad-Option 2)
	└─ Lead Plating System
	G : Green (Halogen Free and Pb Free)

Note :

Richtek products are :

- ▶ RoHS compliant and compatible with the current requirements of IPC/JEDEC J-STD-020.
- ▶ Suitable for use in SnPb or Pb-free soldering processes.

### Features

- Input Voltage as Low as 1.4V
- Ultra-Low Dropout Voltage 400mV @ 2A
- Over-Current Protection
- Over-Temperature Protection
- 1.5µA Input Current in Shutdown Mode
- Enable Control
- RoHS Compliant and Halogen Free

### Applications

- Telecom/Networking Cards
- Motherboards/Peripheral Cards
- Industrial Applications
- Wireless Infrastructure
- Set-Top Box
- Medical Equipment
- Notebook Computers
- Battery Powered Systems

### Pin Configuration

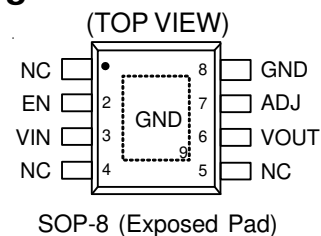

### Marking Information

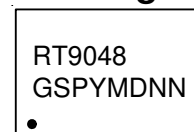

RT9048GSP : Product Number  
YMDNN : Date Code

### Simplified Application Circuit

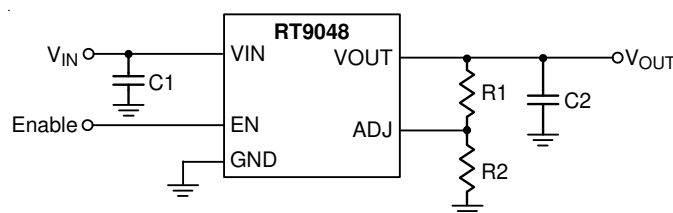

## Functional Pin Description

Pin No.	Pin Name	Pin Function
1, 4, 5	NC	No internal connection.
2	EN	Enable control input (Active-High). Pulling this pin below 0.4V turns the regulator off, reducing the quiescent current to a fraction of its operating value. The device will be enabled if this pin is left open. Connect to VIN if not being used.
3	VIN	Supply voltage input. For regulation at full load, the input to this pin must be between (VOUT + 0.5V) and 6V. The minimum input voltage is 1.4V. A large bulk capacitance should be placed closely to this pin to ensure that the input supply does not sag below 1.4V. Also, a minimum of 10μF ceramic capacitor should be placed directly at this pin.
6	VOUT	Output voltage. A minimum of 10μF capacitor should be placed directly at this pin.
7	ADJ	Feedback voltage input. If connected to the VOUT pin, the output voltage will be set at 0.5V. If external feedback resistors are used, the output voltage will be determined by the resistor ratio.
8, 9 (Exposed pad)	GND	Ground. The exposed pad must be soldered to a large PCB and connected to GND for maximum power dissipation.

## Functional Block Diagram

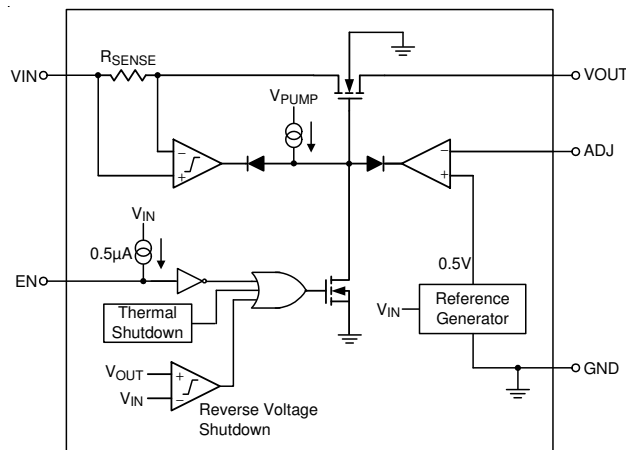

## Operation

The RT9048 is a low dropout voltage linear regulator designed specially for low external components system.

### Output Transistor

The RT9048 builds in a N-MOSFET output transistor which provides a low switch-on resistance for low dropout voltage applications.

### Error Amplifier

The Error Amplifier compares the internal reference voltage with the output feedback voltage, and controls the Gate voltage of N-MOSFET to support good line regulation and load regulation at output voltage.

### Current-Limit Protection

The RT9048 provides current limit function to prevent the device from damages during over-load or shorted-circuit condition. This current is detected by an internal sensing resistor.

### Over-Temperature Protection

The over-temperature protection function will turn off the P-MOSFET when the junction temperature exceeds 160°C (typ.). Once the junction temperature cools down by approximately 30°C, the regulator will automatically resume operation.

**Absolute Maximum Ratings** (Note 1)

- Supply Voltage,  $V_{IN}$  ----- -0.3V to 7V
- Other Pins ----- -0.3V to 6V
- Power Dissipation,  $P_D$  @  $T_A = 25^\circ\text{C}$   
 SOP-8 (Exposed Pad) ----- 2.04W
- Package Thermal Resistance (Note 2)  
 SOP-8 (Exposed Pad),  $\theta_{JA}$  ----- 49°C/W  
 SOP-8 (Exposed Pad),  $\theta_{JC}$  ----- 15°C/W
- Lead Temperature (Soldering, 10 sec.) ----- 260°C
- Junction Temperature ----- 150°C
- Storage Temperature Range ----- -65°C to 150°C
- ESD Susceptibility (Note 3)  
 HBM (Human Body Model) ----- 2kV

**Recommended Operating Conditions** (Note 4)

- Supply Voltage,  $V_{IN}$  ----- 1.4V to 6V
- Junction Temperature Range ----- -40°C to 125°C
- Ambient Temperature Range ----- -40°C to 85°C

**Electrical Characteristics**

( $V_{IN} = 1.4\text{V}$  to  $6\text{V}$ ,  $I_{OUT} = 10\mu\text{A}$  to  $2\text{A}$ ,  $V_{ADJ} = V_{OUT}$ ,  $T_A = 25^\circ\text{C}$ , unless otherwise specified)

Parameter	Symbol	Test Conditions	Min	Typ	Max	Unit
Quiescent Current	$I_Q$	$V_{IN} = 3.3\text{V}$ , $I_{OUT} = 0\text{A}$	--	0.7	--	mA
Shutdown Current	$I_{SHDN}$	$V_{IN} = 6\text{V}$ , $V_{EN} = 0\text{V}$	--	1.5	10	$\mu\text{A}$
Output Voltage	$V_{OUT}$	$V_{IN} = V_{OUT} + 0.5\text{V}$ , $I_{OUT} = 10\text{mA}$	-2	--	2	%
		$V_{IN} = 1.8\text{V}$ , $I_{OUT} = 0.8\text{A}$				
Line Regulation	$\Delta V_{LINE}$	$I_{OUT} = 10\text{mA}$	--	0.2	--	%/V
Load Regulation	$\Delta V_{LOAD}$	$I_{OUT} = 10\text{mA}$ to $2\text{A}$	--	0.5	--	%
Dropout Voltage	$V_{DROP}$	$I_{OUT} = 1\text{A}$ , $V_{IN} \geq 1.6\text{V}$	--	120	200	mV
		$I_{OUT} = 1\text{A}$ , $1.4\text{V} < V_{IN} < 1.6\text{V}$	--	--	400	
		$I_{OUT} = 1.5\text{A}$ , $V_{IN} \geq 1.6\text{V}$	--	180	300	
		$I_{OUT} = 1.5\text{A}$ , $1.4\text{V} < V_{IN} < 1.6\text{V}$	--	--	500	
		$I_{OUT} = 2\text{A}$ , $V_{IN} \geq 1.6\text{V}$	--	240	400	
		$I_{OUT} = 2\text{A}$ , $1.4\text{V} < V_{IN} < 1.6\text{V}$	--	--	600	
Current Limit	$I_{LIM}$	$V_{IN} = 3.3\text{V}$	--	3	--	A
<b>Feedback</b>						
ADJ Reference Voltage	$V_{ADJ}$	$V_{IN} = 3.3\text{V}$ , $V_{ADJ} = V_{OUT}$ , $I_{OUT} = 10\text{mA}$	0.495	--	0.505	V
ADJ Pin Current	$I_{ADJ}$	$V_{ADJ} = 0.5\text{V}$	--	20	200	nA

Parameter		Symbol	Test Conditions	Min	Typ	Max	Unit
<b>Enable</b>							
EN Pin Current		$I_{EN}$	$V_{EN} = 0V, V_{IN} = 6V$	--	1	10	$\mu A$
Enable Threshold Voltage	H-Level	$V_{ENH}$	$V_{IN} = 3.3V$	0.86	1.08	1.3	V
	L-Level	$V_{ENL}$	$V_{IN} = 3.3V$	0.8	1.02	1.24	
<b>Over-Temperature Protection</b>							
OTP Trip Level				--	160	--	$^{\circ}C$
Hysteresis				--	30	--	$^{\circ}C$

- Note 1.** Stresses beyond those listed under “Absolute Maximum Ratings” may cause permanent damage to the device. These are stress ratings only, and functional operation of the device at these or any other conditions beyond those indicated in the operational sections of the specifications is not implied. Exposure to absolute maximum rating conditions may affect device reliability.
- Note 2.**  $\theta_{JA}$  is measured at  $T_A = 25^{\circ}C$  on a high effective thermal conductivity four-layer test board per JEDEC 51-7.  $\theta_{JC}$  is measured at the exposed pad of the package.
- Note 3.** Devices are ESD sensitive. Handling precaution is recommended.
- Note 4.** The device is not guaranteed to function outside its operating conditions.

**Typical Application Circuit**

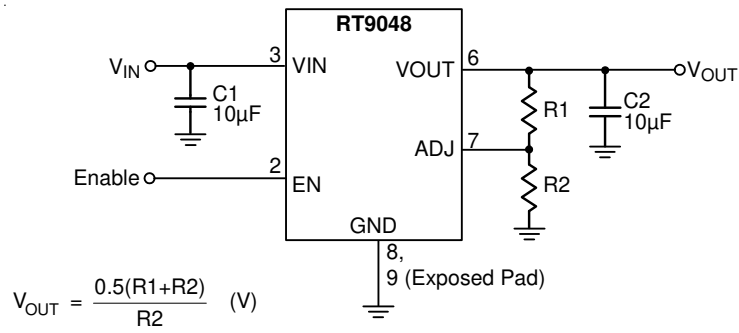
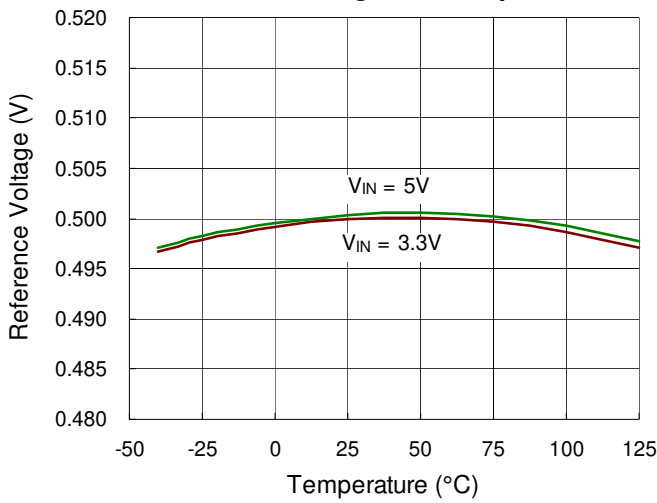

Figure 1. Adjustable Voltage Regulator

Typical Operating Characteristics

Reference Voltage vs. Temperature



Quiescent Current vs. Temperature

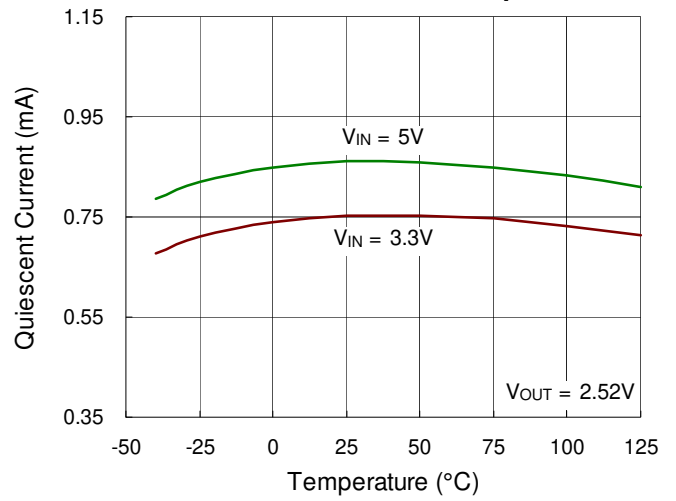

Shutdown Current vs. Temperature

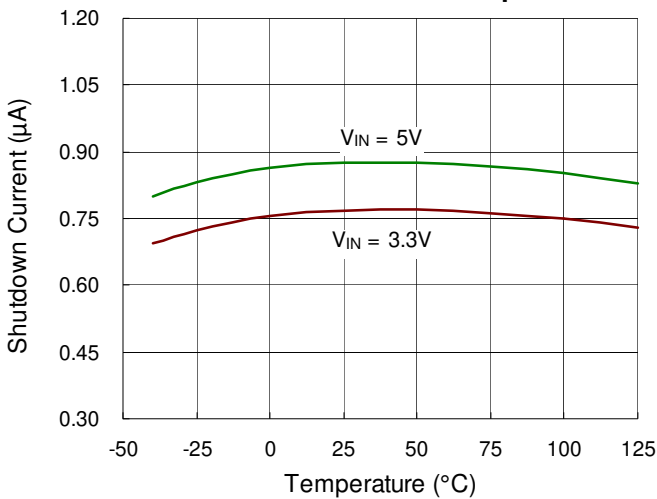

UVLO vs. Temperature

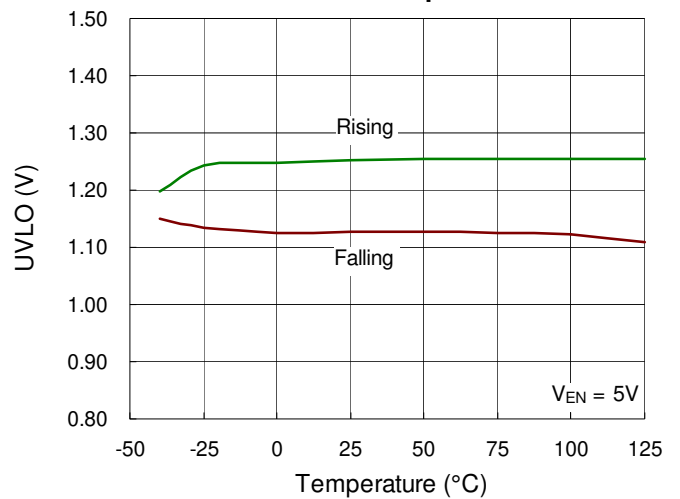

Dropout Voltage vs. Load Current

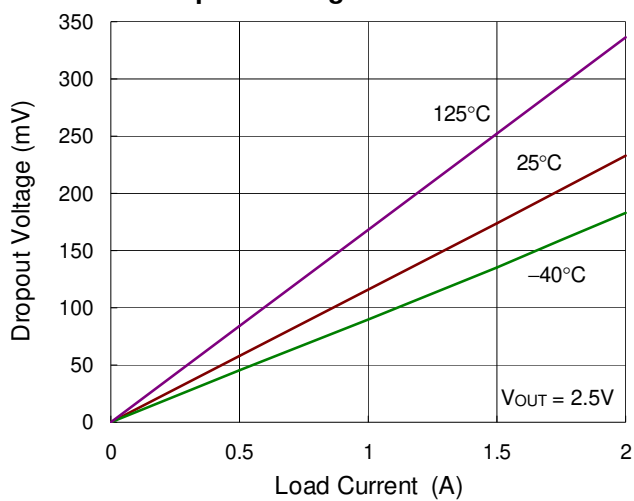

EN Threshold Voltage vs. Input Voltage

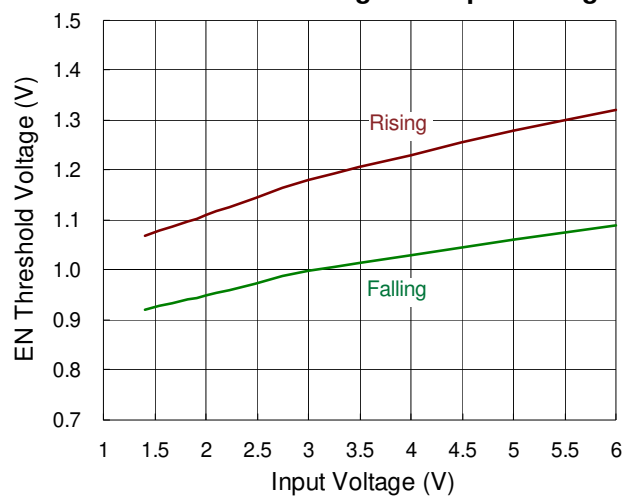

EN Threshold Voltage vs. Temperature

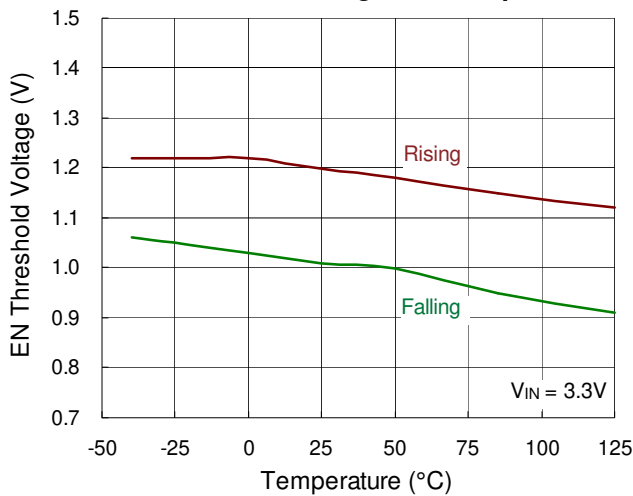

Load Transient Response

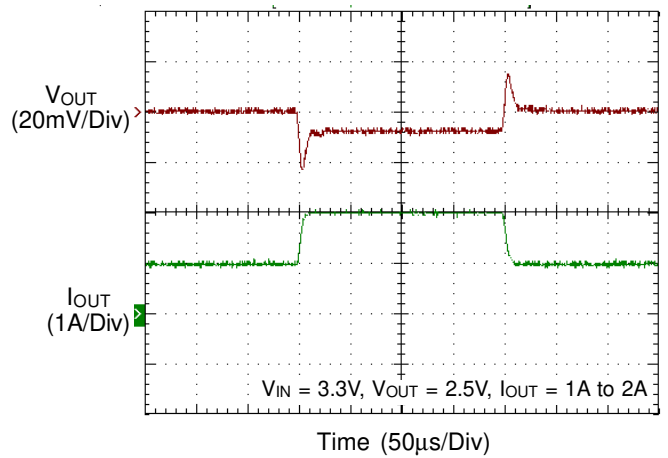

Line Transient Response

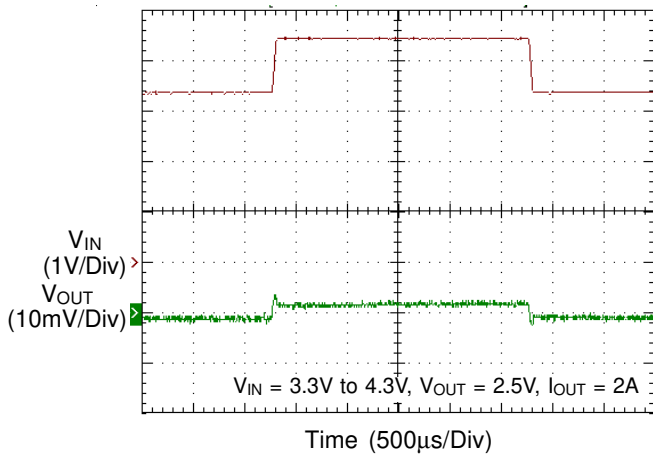

Power On from EN

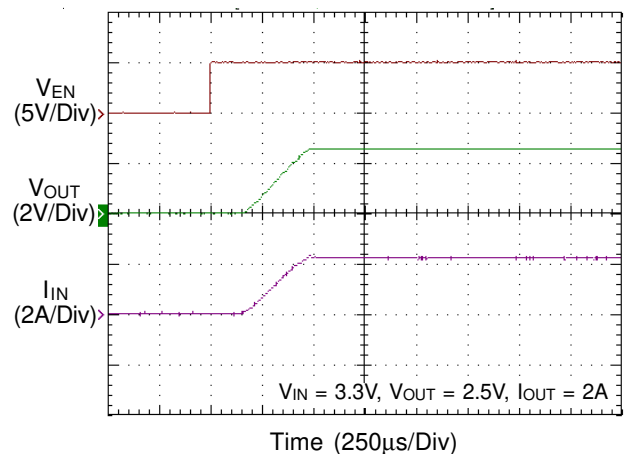

Power Off from EN

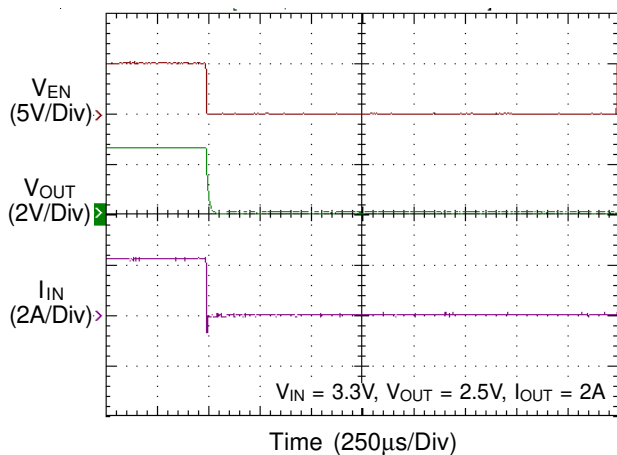

PSRR

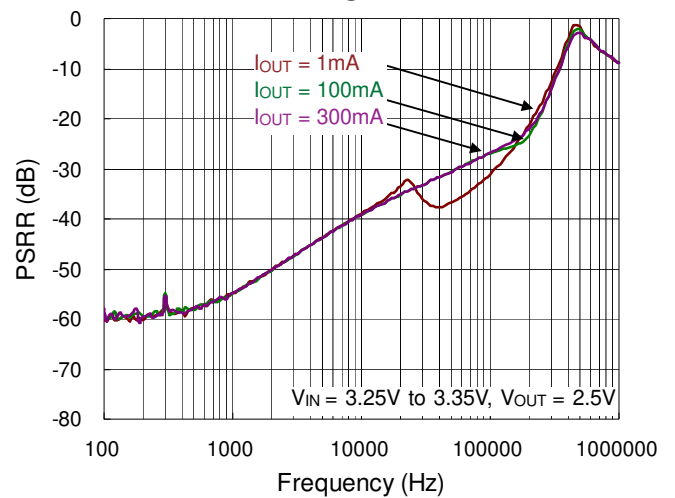

## Application Information

The RT9048 is a low voltage, low dropout linear regulator with an external bias supply input capable of supporting an input voltage range from 1.4V to 6V.

### Output Voltage Setting

The RT9048 output voltage is adjustable from 0.5V to  $V_{IN} - V_{DROPO}$  via the external resistive voltage divider. The voltage divider resistors can have values of up to 800k $\Omega$  because of the very high impedance and low bias current of the sense comparator. The output voltage is set according to the following equation :

$$V_{OUT} = V_{ADJ} \times \left( 1 + \frac{R1}{R2} \right)$$

where  $V_{ADJ}$  is the reference voltage with a typical value of 0.5V.

### Chip Enable Operation

The RT9048 goes into sleep mode when the EN pin is in a logic low condition. In this condition, the pass transistor, error amplifier, and band gap are all turned off, reducing the supply current to only 10 $\mu$ A (max.). The EN pin can be directly tied to  $V_{IN}$  to keep the part on.

### UVLO Protection

The RT9048 provides an input under-voltage lockout protection (UVLO). When the input voltage exceeds the UVLO rising threshold voltage (1.2V typ.), the device resets the internal circuit and prepares for operation. If the input voltage falls below the UVLO falling threshold voltage during normal operation, the device will be shut down. A hysteresis (140mV typ.) between the UVLO rising and falling threshold voltage is designed to avoid noise.

### Current Limit

The RT9048 contains an independent current limit circuitry, which monitors and controls the pass transistor's gate voltage, limiting the output current to 3A (typ.).

### $C_{IN}$ and $C_{OUT}$ Selection

Like any low dropout regulator, the external capacitors of the RT9048 must be carefully selected for regulator stability and performance. Using a capacitor of at least 10 $\mu$ F is suitable. The input capacitor must be located at a distance of not more than 0.5 inch from the input pin of the IC. Any good quality ceramic capacitor can be used. However, a capacitor with larger value and lower ESR (Equivalent Series Resistance) is recommended since it will provide better PSRR and line transient response.

The RT9048 is designed specifically to work with low ESR ceramic output capacitor for space saving and performance consideration. Using a ceramic capacitor with capacitance of at least 10 $\mu$ F and ESR larger than 1m $\Omega$  on the RT9048 output ensures stability. Nevertheless, the RT9048 can still work well with other types of output capacitors due to its wide range of stable ESR. Figure 3 shows the allowable ESR range as a function of load current for various output capacitance. Output capacitors with larger capacitance can reduce noise and improve load transient response, stability, and PSRR. The output capacitor should be located at a distance of not more than 0.5 inch from the output pin of the RT9048.

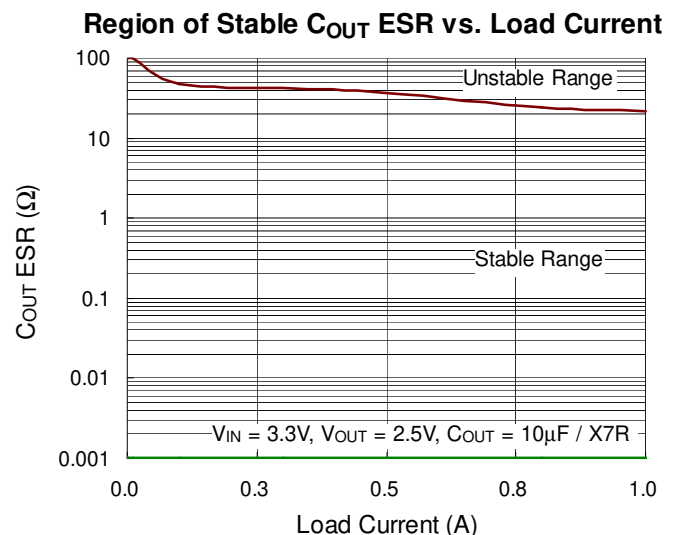

Figure 3



**Thermal Considerations**

Thermal protection limits power dissipation in the RT9048. When the operation junction temperature exceeds 160°C, the OTP circuit starts the thermal shutdown function and turns the pass element off. The pass element turns on again after the junction temperature cools by 30°C.

The RT9048 output voltage will be closed to zero when output short circuit occurs as shown in Figure 4. It can reduce the IC temperature and provides maximum safety to end users when output short circuit occurs.

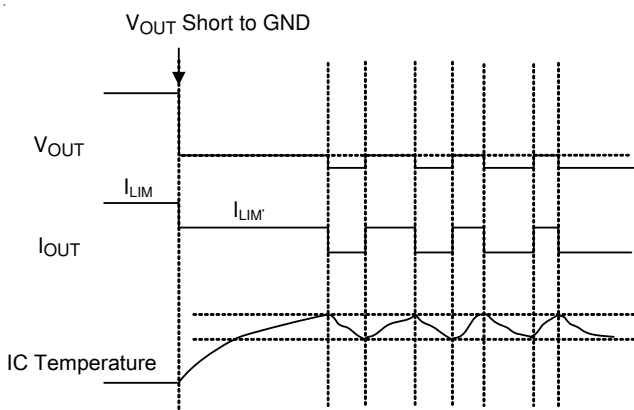

Figure 4. Short Circuit Protection when Output Short Circuit Occurs

For continuous operation, do not exceed absolute maximum junction temperature. The maximum power dissipation depends on the thermal resistance of the IC package, PCB layout, rate of surrounding airflow, and difference between junction and ambient temperature. The maximum power dissipation can be calculated by the following formula :

$$P_{D(MAX)} = (T_{J(MAX)} - T_A) / \theta_{JA}$$

where T<sub>J(MAX)</sub> is the maximum junction temperature, T<sub>A</sub> is the ambient temperature, and θ<sub>JA</sub> is the junction to ambient thermal resistance.

For recommended operating condition specifications, the maximum junction temperature is 125°C. The junction to ambient thermal resistance, θ<sub>JA</sub>, is layout dependent. For SOP-8 (Exposed Pad) package, the thermal resistance, θ<sub>JA</sub>, is 49°C/W on a standard JEDEC 51-7 four-layer thermal test board. The maximum power dissipation at T<sub>A</sub> = 25°C can be calculated by the following formula :

$$P_{D(MAX)} = (125^{\circ}\text{C} - 25^{\circ}\text{C}) / (49^{\circ}\text{C}/\text{W}) = 2.04\text{W for SOP-8 (Exposed Pad) package}$$

The maximum power dissipation depends on the operating ambient temperature for fixed T<sub>J(MAX)</sub> and thermal resistance, θ<sub>JA</sub>. The derating curve in Figure 5 allows the designer to see the effect of rising ambient temperature on the maximum power dissipation.

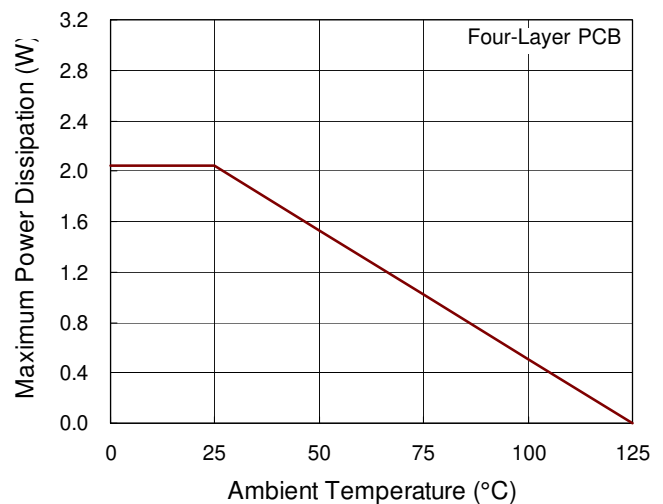
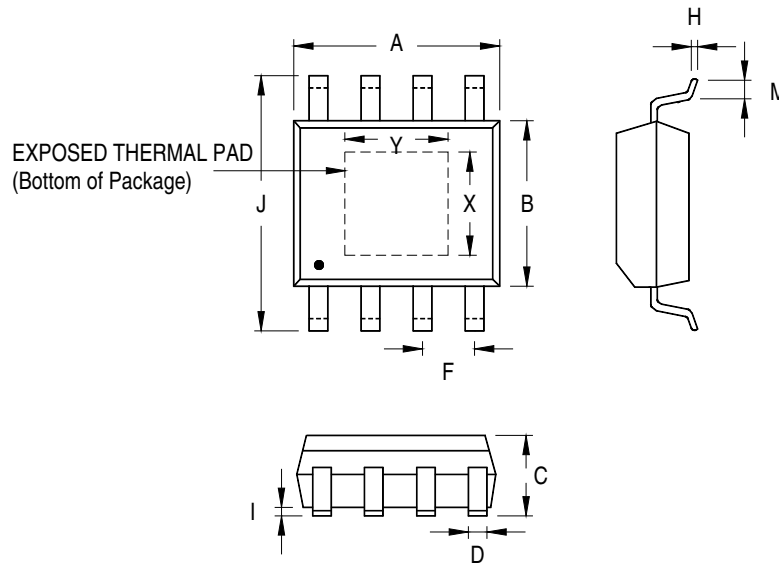

Figure 5. Derating Curve of Maximum Power Dissipation

Outline Dimension



Symbol	Dimensions In Millimeters		Dimensions In Inches		
	Min	Max	Min	Max	
A	4.801	5.004	0.189	0.197	
B	3.810	4.000	0.150	0.157	
C	1.346	1.753	0.053	0.069	
D	0.330	0.510	0.013	0.020	
F	1.194	1.346	0.047	0.053	
H	0.170	0.254	0.007	0.010	
I	0.000	0.152	0.000	0.006	
J	5.791	6.200	0.228	0.244	
M	0.406	1.270	0.016	0.050	
Option 1	X	2.000	2.300	0.079	0.091
	Y	2.000	2.300	0.079	0.091
Option 2	X	2.100	2.500	0.083	0.098
	Y	3.000	3.500	0.118	0.138

8-Lead SOP (Exposed Pad) Plastic Package

Richtek Technology Corporation

14F, No. 8, Tai Yuen 1<sup>st</sup> Street, Chupei City  
 Hsinchu, Taiwan, R.O.C.  
 Tel: (8863)5526789

Richtek products are sold by description only. Customers should obtain the latest relevant information and data sheets before placing orders and should verify that such information is current and complete. Richtek cannot assume responsibility for use of any circuitry other than circuitry entirely embodied in a Richtek product. Information furnished by Richtek is believed to be accurate and reliable. However, no responsibility is assumed by Richtek or its subsidiaries for its use; nor for any infringements of patents or other rights of third parties which may result from its use. No license is granted by implication or otherwise under any patent or patent rights of Richtek or its subsidiaries.