

CC2538-CC2592 Evaluation Module Kit Quick Start Guide

Opening the Box and Running the Packet Error Rate Test

1. Kit Contents

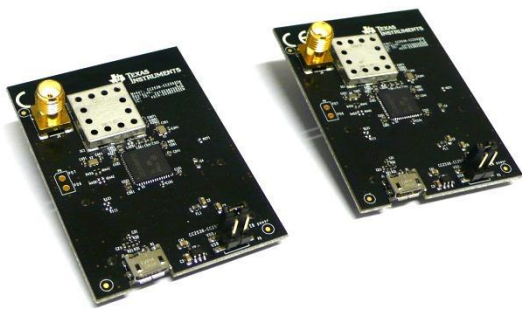

2 x CC2538-CC2592 Evaluation Modules

The RF boards in this kit are FCC and IC certified and tested/comply with ETSI/R&TTE over temperature from 0 to 35°C.

FCC/IC Regulatory Compliance
FCC Part 15 Class A Compliant
IC ICES-003 Class A Compliant

2. How to use the Modules

The EMK is an add-on kit to supplement the CC2538DK with evaluation boards.

The CC2538-CC2592EM boards can be plugged into the SmartRF06 Evaluation Board from Texas Instruments. This board is included in the CC2538DK and in the SmartRF06EBK.

This board lets you run a packet error rate (PER) test, control the device from SmartRF™ Studio and it can be used as a development platform.

It is also possible to connect the EM to other TI development boards with the appropriate connectors

This guide will show how to use the modules together with SmartRF06EB.

3. CC2538-CC2592EM Overview

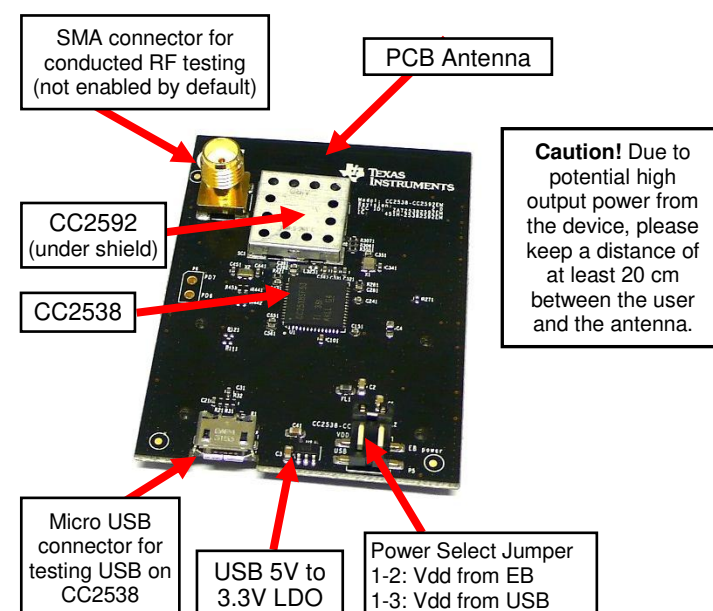

Caution! Due to potential high output power from the device, please keep a distance of at least 20 cm between the user and the antenna.

4. Plug the EM into the 06EB

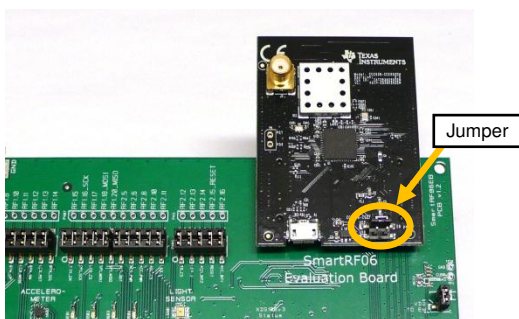

Insert a CC2538-CC2592EM board into the SmartRF06EB as shown above.

Note! On the CC2538-CC2592EM, make sure you connect a jumper on the upper row on the 4-pin header.



Caution! The kit contains ESD sensitive components. Handle with care to prevent permanent damage.

5. Power Options

The CC2538-CC2592EM should be powered through the SmartRF06EB, which will supply a voltage from 2.1V to 3.6V to the daughter card. The SmartRF06EB can be powered in several different ways:

- USB (5V through USB plug)
- 2 x 1.5V AAA alkaline batteries
- External power supply (see below)

Voltage regulators on the SmartRF06EB will set the on-board voltage to 2.1V or 3.3V.

External Regulated Power Supply¹ Requirements:
Nom Voltage: 2.1 to 3.3 VDC. MAX 3.6 VDC.
Max Current: 1000 mA
Efficiency Level V

Warning! To minimize risk of injury or property damage, never use rechargeable batteries to power the board.

6. Select Power Source

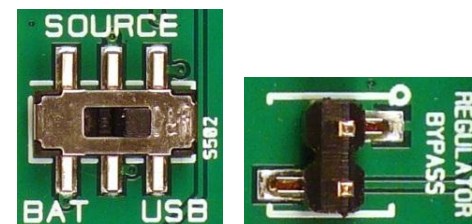

The power source is selected using the Source switch on the left hand side of the SmartRF06EB.

In "USB" position, the EM is powered over USB, running at 3.3V. In "BAT" position, the board is powered from batteries or an external source, running at 2.1V. The 2.1V regulator can be bypassed by shorting the pins on the "regulator bypass" jumper. In this case, the EM is powered directly from the external source or batteries.

Note that there should only be one active power source at any one time. Do not leave the EVM powered when unattended.

7. Welcome Screen

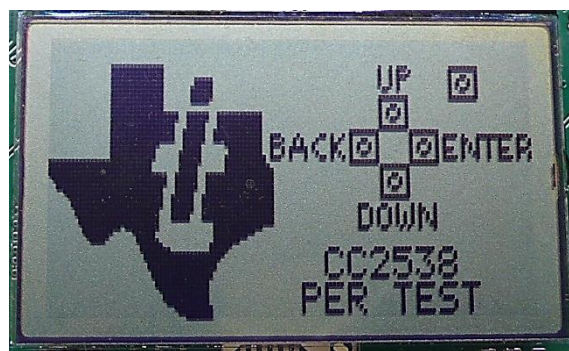

Turn on power with the Main Power switch. You should now see the Texas Instruments logo and a short description of the buttons on the LCD. Pushing any of the five buttons on the board will take you to the main menu.

NB! If you don't see anything on the screen make sure the board is correctly powered (see step 5 and 6 above).

8. Select Board and Channel

Start by selecting the plug-in board you have, either the CC2538EM or the combo board CC2538-CC2591EM.

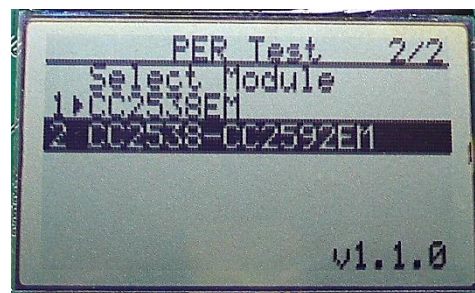

Then select which channel (frequency) to use.

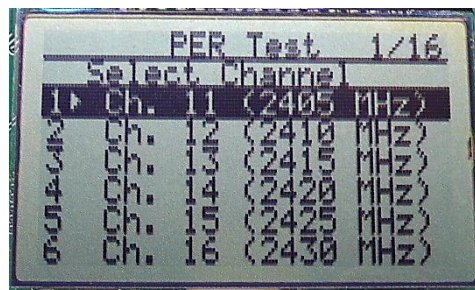

9. Select Mode

One of the boards must operate as a transmitter and the other as a receiver. Select transmitter on one board ...



... and receiver on the other board.

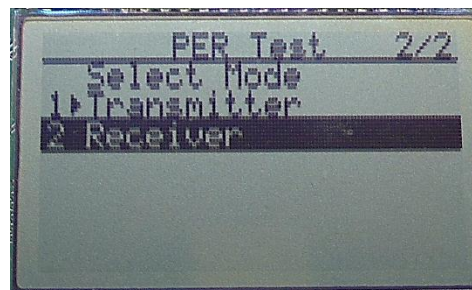

¹ When using an external power supply, make sure it meets the listed requirements in addition to complying with applicable regional product regulatory and safety certification requirements such as UL, CSA, VDE, CCC, and PSE.

10. Select RX Gain Mode

On the receiver, select either high gain or low gain mode for the CC2592.

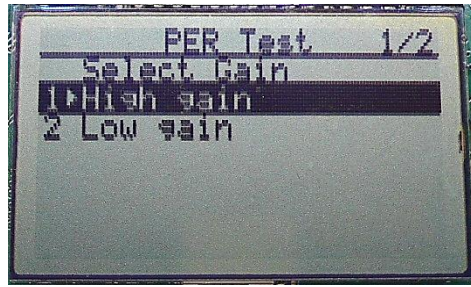

The receiver is now ready to receive packets.

Continue with the configuration of the transmitter.

11. Select TX Power

On the transmitter, select desired output power.

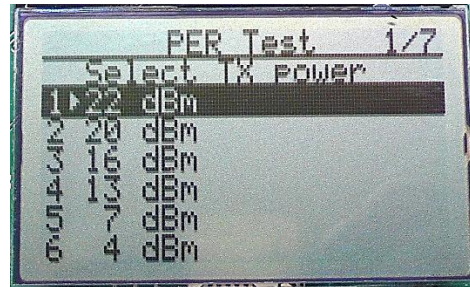

12. Select Packet Rate

Still on the transmitter, select the desired burst size, that is, the number of packets to transmit.

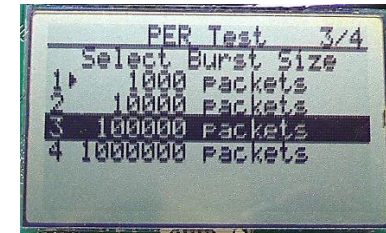

Then select the packet rate.

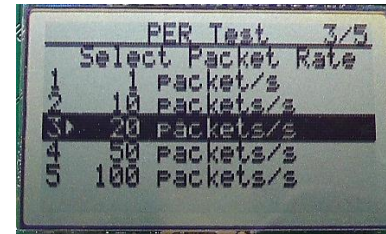

13. Start Sending Packets

The transmitter is now configured and in idle state. Sending packets is started and stopped by pressing the Select button.

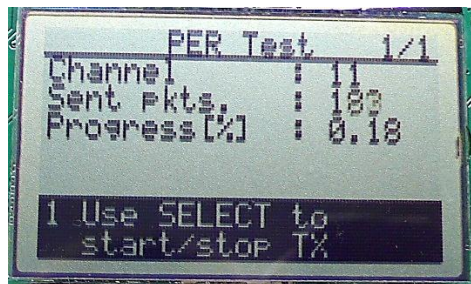

14. PER Test Results

On the receiver, the statistics window will show the error rate based on the number of lost or erroneous packets divided by the total number of packets that should have been received.

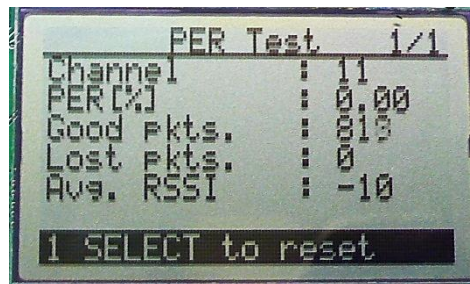

15. References

Please visit www.ti.com and

<http://www.ti.com/tool/cc2538-cc2592emk>
<http://www.ti.com/tool/cc2538dk>

The reference design for the evaluation board can be found here:

<http://www.ti.com/tool/cc2538-cc2592em-rd>

On the kit product page, you will find additional documentation, links to updated software examples and software tools like SmartRF Studio.

You will also find a lot of information on the TI E2E forum at <http://e2e.ti.com>

We hope that you will enjoy working with the CC2592 and CC2538 devices.

16. Troubleshooting

If you are experiencing problems with this test, please check the following:

- Nothing is shown in the display! Make sure the board is powered correctly (see steps 5 and 6 above).
- Please visit the kit web page and check for updated SW and documentation. Updated SW can be downloaded to the device using IAR Embedded Workbench for ARM or SmartRF Flash Programmer 2.

SmartRF™ Studio

1. Download and Install

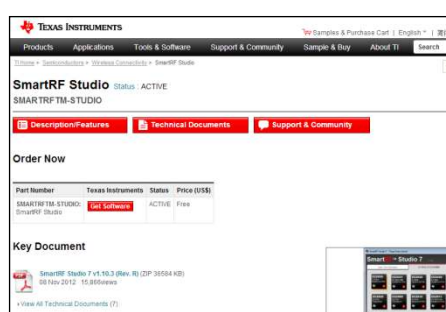

Before connecting SmartRF06EB to your PC, download and install SmartRF Studio from www.ti.com/smarterfstudio.

2. Launch SmartRF Studio



After installing the tool, connect the EB to the PC using the USB cable and start SmartRF Studio. Select the "2.4 GHz" tab and click the refresh ("Find device") button in the lower right corner. Studio will now find the connected SmartRF06EB. Double click on the detected SmartRF06EB to launch the CC2538 device control panel.

3. Test the Radio

In the device control panel for CC2538, select the range extender CC2592.

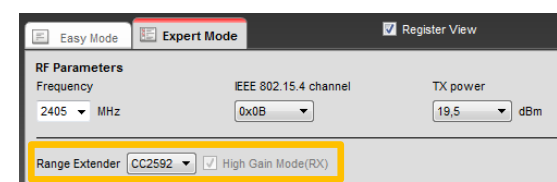

You can now configure the radio, run performance tests, export register settings and run link tests with another CC2538 on a SmartRF06EB connected to the PC.

IMPORTANT NOTICE

Texas Instruments Incorporated and its subsidiaries (TI) reserve the right to make corrections, enhancements, improvements and other changes to its semiconductor products and services per JESD46, latest issue, and to discontinue any product or service per JESD48, latest issue. Buyers should obtain the latest relevant information before placing orders and should verify that such information is current and complete. All semiconductor products (also referred to herein as "components") are sold subject to TI's terms and conditions of sale supplied at the time of order acknowledgment.

TI warrants performance of its components to the specifications applicable at the time of sale, in accordance with the warranty in TI's terms and conditions of sale of semiconductor products. Testing and other quality control techniques are used to the extent TI deems necessary to support this warranty. Except where mandated by applicable law, testing of all parameters of each component is not necessarily performed.

TI assumes no liability for applications assistance or the design of Buyers' products. Buyers are responsible for their products and applications using TI components. To minimize the risks associated with Buyers' products and applications, Buyers should provide adequate design and operating safeguards.

TI does not warrant or represent that any license, either express or implied, is granted under any patent right, copyright, mask work right, or other intellectual property right relating to any combination, machine, or process in which TI components or services are used. Information published by TI regarding third-party products or services does not constitute a license to use such products or services or a warranty or endorsement thereof. Use of such information may require a license from a third party under the patents or other intellectual property of the third party, or a license from TI under the patents or other intellectual property of TI.

Reproduction of significant portions of TI information in TI data books or data sheets is permissible only if reproduction is without alteration and is accompanied by all associated warranties, conditions, limitations, and notices. TI is not responsible or liable for such altered documentation. Information of third parties may be subject to additional restrictions.

Resale of TI components or services with statements different from or beyond the parameters stated by TI for that component or service voids all express and any implied warranties for the associated TI component or service and is an unfair and deceptive business practice. TI is not responsible or liable for any such statements.

Buyer acknowledges and agrees that it is solely responsible for compliance with all legal, regulatory and safety-related requirements concerning its products, and any use of TI components in its applications, notwithstanding any applications-related information or support that may be provided by TI. Buyer represents and agrees that it has all the necessary expertise to create and implement safeguards which anticipate dangerous consequences of failures, monitor failures and their consequences, lessen the likelihood of failures that might cause harm and take appropriate remedial actions. Buyer will fully indemnify TI and its representatives against any damages arising out of the use of any TI components in safety-critical applications.

In some cases, TI components may be promoted specifically to facilitate safety-related applications. With such components, TI's goal is to help enable customers to design and create their own end-product solutions that meet applicable functional safety standards and requirements. Nonetheless, such components are subject to these terms.

No TI components are authorized for use in FDA Class III (or similar life-critical medical equipment) unless authorized officers of the parties have executed a special agreement specifically governing such use.

Only those TI components which TI has specifically designated as military grade or "enhanced plastic" are designed and intended for use in military/aerospace applications or environments. Buyer acknowledges and agrees that any military or aerospace use of TI components which have *not* been so designated is solely at the Buyer's risk, and that Buyer is solely responsible for compliance with all legal and regulatory requirements in connection with such use.

TI has specifically designated certain components as meeting ISO/TS16949 requirements, mainly for automotive use. In any case of use of non-designated products, TI will not be responsible for any failure to meet ISO/TS16949.

Products

Audio	www.ti.com/audio
Amplifiers	amplifier.ti.com
Data Converters	dataconverter.ti.com
DLP® Products	www.dlp.com
DSP	dsp.ti.com
Clocks and Timers	www.ti.com/clocks
Interface	interface.ti.com
Logic	logic.ti.com
Power Mgmt	power.ti.com
Microcontrollers	microcontroller.ti.com
RFID	www.ti-rfid.com
OMAP Applications Processors	www.ti.com/omap
Wireless Connectivity	www.ti.com/wirelessconnectivity

Applications

Automotive and Transportation	www.ti.com/automotive
Communications and Telecom	www.ti.com/communications
Computers and Peripherals	www.ti.com/computers
Consumer Electronics	www.ti.com/consumer-apps
Energy and Lighting	www.ti.com/energy
Industrial	www.ti.com/industrial
Medical	www.ti.com/medical
Security	www.ti.com/security
Space, Avionics and Defense	www.ti.com/space-avionics-defense
Video and Imaging	www.ti.com/video

TI E2E Community

e2e.ti.com