

# Latching Relay G2AK

## Magnetic Latching Version of G2A Ideal for Sequence Control

- Double-winding latch system with continuous rating.
- Terminals pulled from the respective junctions between the built-in diodes and set and reset coils allow the built-in diodes to be externally connected for coil surge absorption.
- Excellent vibration/shock resistance with minimal secular decrease in latching power.
- Easy monitoring of ON/OFF operation due to the built-in operation indicator mechanism.
- Same outline dimensions as the standard models of G2A.



## Ordering Information

Contact form	Classification	Plug-in terminals	PCB terminals
DPDT	Standard model	G2AK-232A	G2AK-2321P
	Arc barrier equipped model	G2AK-232AY	---
	Fully sealed model	G2AK-234A	---

**Note:** 1. When placing your order, add the coil voltage rating to the model number as shown below.  
Example: G2AK-232A 100 VAC

Rated coil voltage

- The applicable rated voltage range can be increased by connecting an external resistor. Refer to *Specifications* for details.
- Models meeting UL standards must be specified when ordering. Add "-US" after the model number.

## Model Number Legend

G2AK-□□□□□□-□  
1 2 3 4 5 6

### 1. Number of Poles (Contact Form)

2: DPDT

### 2. Contact Type

3: Crossbar bifurcated

### 3. Enclosure Construction

2: Casing

4: Fully sealed

### 4. Terminal Shape

A: Plug-in terminal

1P: PCB terminal

### 5. Safety Breaking Mechanism

None: No

Y: Arc barrier

### 6. Approved Standards

None: Standard

US: UL-approved

Arc barrier equipped model	Fully sealed model
The arc barrier equipped model is a relay designed to prevent arc short-circuiting between phases and can be used in a circuit which has potential difference between phases. The switching power of such a circuit with potential difference must be limited to less than 1/2 the rated load when using this Relay.	The fully sealed model is a relay in a gas-tight plastic enclosure and thus exhibits stable performance in an adverse atmosphere of harmful gas, moisture, or powdery dust.

## ■ Accessories (Order Separately)

### Sockets

Item	DIN Track-mounting Socket	Back-connecting Relay			
	Screw terminals	Solder terminals	Wire-wrap terminals	PCB terminals	
Without Hold-down Clip	PYF14A(-E) PYF14A-TU PYF14T	PY14 PY14-3	PY14QN(2)	PY14-0	PY14-02
With Hold-down Clip	---	PY14-Y2	PY14QN-Y2	---	---

**Note:** See the G2A Datasheet for detailed information on the Relay Hold-down Clips and Socket Mounting Plates.

## Specifications

### ■ Coil Ratings

Rated voltage	Set coil			Reset coil			Set voltage	Reset voltage	Max. voltage	Power consumption	
	Rated current		Coil resistance	Rated current		Coil resistance				Set coil	Reset coil
	50 Hz	60 Hz		50 Hz	60 Hz						
6 VAC	308 mA	300 mA	6.5 Ω	72 mA	70 mA	32 Ω	80% max. of rated voltage	80% max. of rated voltage	110% of rated voltage	Approx. 1.6 to 2.0 VA	Approx. 0.5 to 1.2 VA
12 VAC	162 mA	158 mA	28 Ω	40 mA	39 mA	125 Ω					
24 VAC	66 mA	64 mA	145 Ω	22.6 mA	22 mA	460 Ω					
50 VAC	34 mA	33 mA	590 Ω	11.3 mA	11 mA	1,900 Ω					
100 VAC	19 mA	18.5 mA	2,150 Ω	12.3 mA	12 mA	3,600 Ω					
6 VDC	360 mA		14 Ω	160 mA		32 Ω				Approx. 2.0 to 2.2 W	Approx. 1.0 to 1.2 W
12 VDC	170 mA		65 Ω	85 mA		125 Ω					
24 VDC	85 mA		270 Ω	50 mA		460 Ω					
48 VDC	44 mA		1,050 Ω	24 mA		1,900 Ω					

**Note:** 1. The rated current and coil resistance are measured at a coil temperature of 23°C with tolerances of +15%, -20% for AC rated current and ±15% for DC coil resistance.

- The AC coil resistance values are for reference only.
- Performance characteristics data are measured at a coil temperature of 23°C.
- The rated current of the AC operating coil is half-wave rectified current and is measured with a DC ammeter.
- The peak reverse-breakdown voltage of the built-in diode is 1,000V.
- The set coil of the Relay rated at 6 VDC is of the 5-minute rating. However, when it is used by connecting a diode in series, it can be of the continuous rating.
- By connecting an external resistor to each of the set and reset coils as shown in the table below, the rated current of the Relay can be increased.
- The maximum voltage is one that is applicable instantaneously to the Relay coil at 23°C and not continuously.

Rated voltage	Connected coil voltage	External resistor			
		Set coil		Reset coil	
		Resistance	Capacity	Resistance	Capacity
110 VAC	100 VAC	0.27 kΩ	0.5 W min.	0.39 kΩ	1/4 W min.
200 VAC	100 VAC	2.7 kΩ	5 W min.	8.2 kΩ	3 W min.
220 VAC	100 VAC	3.3 kΩ	6 W min.	9.1 kΩ	3 W min.
100 VDC	48 VDC	1.1 kΩ	10 W min.	2.0 kΩ	6 W min.

**Note:** Use a resistor having the above resistance value with tolerances of ±10% for external connection.

## Method of Connection

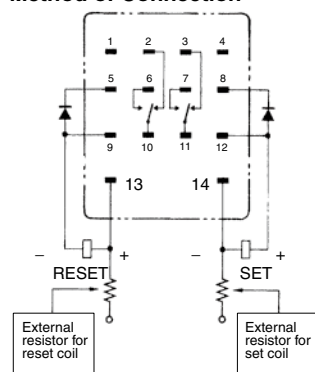

- Reset side  
DC coil: Connect terminal No. 13 to terminal No. 9 or No. 13 to No. 5.  
AC coil: Connect terminal No. 13 to terminal No. 5.
- Set side  
DC coil: Connect terminal No. 14 to terminal No. 12 or No. 14 to No. 8.  
AC coil: Connect terminal No. 14 to terminal No. 8.

## Contact Ratings

Load	Resistive load ( $\cos\phi = 1$ )	Inductive load ( $\cos\phi = 0.4$ ) (L/R = 7 ms)
Contact type	Crossbar bifurcated	
Contact material	Movable: Au-clad AgPd Fixed: AgPd	
Rated load	0.3 A at 110 VAC 0.5 A at 24 VDC	0.2 A at 110 VAC 0.3 A at 24 VDC
Rated carry current	3 A	
Max. switching voltage	250 VAC, 125 VDC	

## Characteristics

Contact resistance (see note 2)	100 m $\Omega$ max.
Set time (see note 3)	AC: 25 ms max.; DC: 15 ms max.
Reset time (see note 3)	AC: 25 ms max.; DC: 15 ms max.
Min. pulse width	AC: 50 ms; DC: 30 ms
Max. operating frequency	Mechanical: 18,000 operations/hour Electrical: 1,800 operations/hour (under rated load)
Insulation resistance (see note 4)	100 M $\Omega$ min. (at 500 VDC)
Dielectric strength	1,500 VAC, 50/60 Hz for 1 minute between coil and contact (700 VAC between contacts of same pole) (1,000 VAC between set and reset coils)
Vibration resistance	Destruction: 10 to 55 to 10 Hz, 0.75 mm single amplitude (1.5 mm double amplitude) Malfunction: 10 to 55 to 10 Hz, 0.5 mm single amplitude (1.0 mm double amplitude) (for contact malfunction); 3.0-mm double amplitude (for armature malfunction)
Shock resistance	Destruction: 1,000 m/s <sup>2</sup> Malfunction: 100 m/s <sup>2</sup> , 300 m/s <sup>2</sup>
Endurance	Mechanical: 100,000,000 operations min. (at operating frequency of 18,000 operations/hour) Electrical: 5,000,000 operations min. (under rated load and at operating frequency of 1,800 operations/hour) (see note 5)
Error rate (level P) (Reference value) (see note 6)	1 mA at 100 mVDC
Ambient temperature	Operating: -10°C to 40°C (with no icing or condensation)
Ambient humidity	Operating: 5% to 85%
Weight	Approx. 38 g

Note: 1. The data shown above are initial values.

2. The contact resistance was measured with 0.1 A at 5 VDC using the fall-of-potential method.

3. The set or reset time was measured with the rated voltage imposed with any contact bounce ignored at an ambient temperature of 23°C.

4. The insulation resistance was measured with a 500-VDC megger applied to the same places as those used for checking the dielectric strength.

5. The electrical endurance was measured at an ambient temperature of 23°C.

6. This value was measured at a switching frequency of 60 operations per minute.

■ Approved by Standards

UL (File No. E41515)

Model	Coil ratings	Contact ratings
G2AK-□	6 to 100 VAC 6 to 50 VDC	1 A 120 VAC (resistive load) 1 A 30 VDC (inductive load)

Engineering Data

Maximum Switching Power

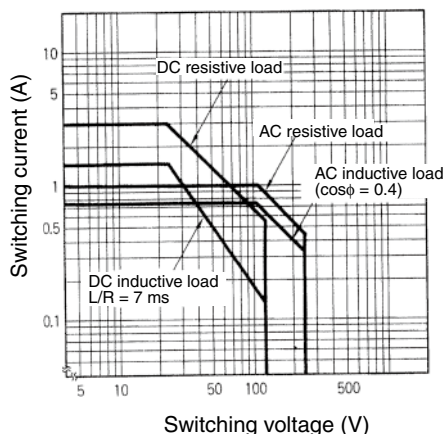

Endurance

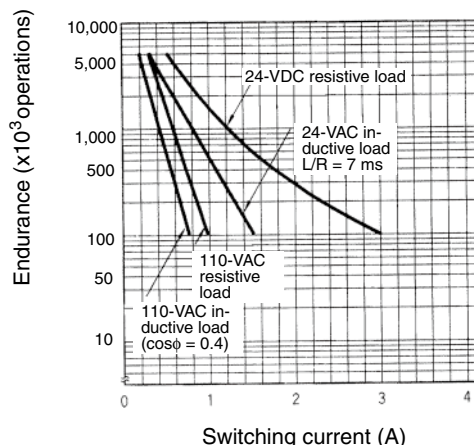

Malfunctioning Shock

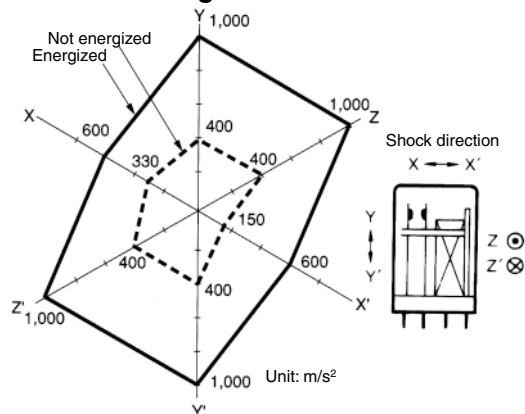

Number of samples = 5  
Measurement conditions: Impose a shock of 100 m/s<sup>2</sup> in the ±X, ±Y, and ±Z directions three times each with the Relay energized and not energized to check the shock values that cause the Relay to malfunction.

Changes in Operating Characteristics vs. External Magnetic Field

G2AK-232A 24 VDC (Mean Value)

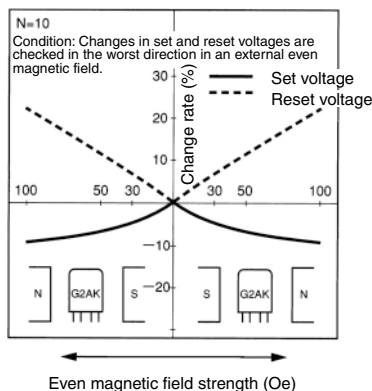

(Mean Value)

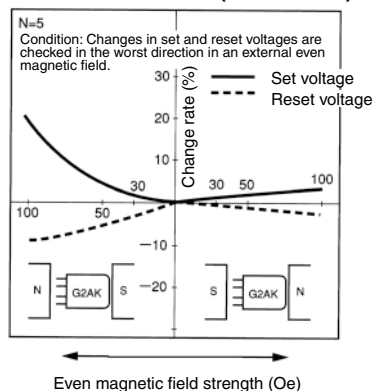

Hold Force Attenuation vs. Elapsed Time

G2AK-232A 24 VDC

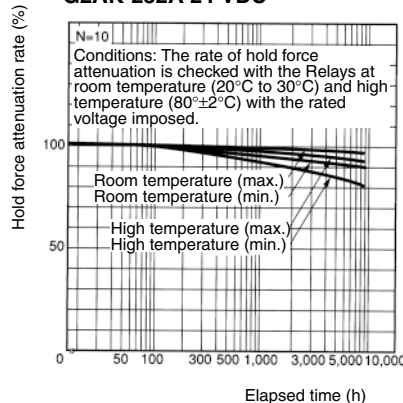

# Dimensions

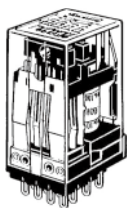

G2AK-232

## Arc Barrier Equipped Models

with Plug-in Terminals  
G2AK-232A(Y)

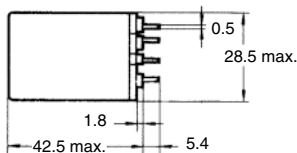
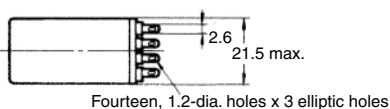

with PCB Terminals  
G2AK-2321P(Y)

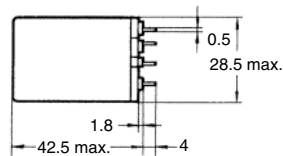
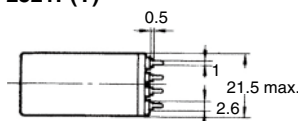

## Fully Sealed Models

with Plug-in Terminals  
G2AK-234A

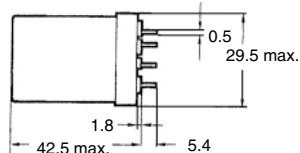
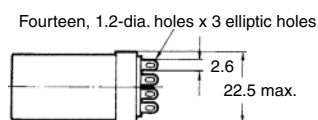

with PCB Terminals  
G2AK-2341P

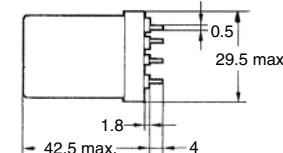
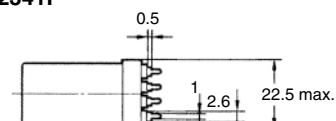

## Mounting Holes on PCB (Bottom View)

Note: Dimensional tolerances are  $\pm 0.1$  mm

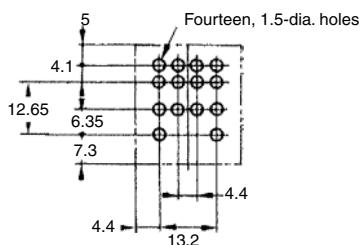

## Terminal Arrangement/Internal Connections (Bottom View)

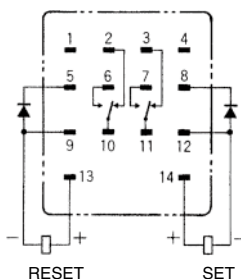

Note: Terminals (Nos. 12 and 9) are pulled from the respective junctions between the diode and set coil and between the diode and reset coil. Use these terminals through external connection for selective use or non-use of the diodes as well as for surge prevention.

# Safety Precautions

Refer to *Safety Precautions for All Relays*.

The G2AK can be used for special purposes by utilizing its built-in diodes.

## When built-in diodes are not required

- With the DC-coil Latching Relay, the built-in diodes become unnecessary for a circuit in which a coil operating switch is incorporated for each of the set and reset coils as shown on the right.
- With the DC/AC-coil Latching Relay, if the junctions between the set coil and built-in diode and between the reset coil and built-in diode are connected as shown on the right, only one of the built-in diode is required and the rest of the diodes become unnecessary. However, a coil operating switch is required for each coil. In this case, because of the diode characteristics, the load rating must be 0.5 A or less.

## When built-in diodes are required

- When using the AC-coil Latching Relay which operates on commercial AC input, the built-in diodes are required.
- With the DC/AC-coil Latching Relay, the built-in diodes are required for an inductive electrical equipment circuit which consists of two or more set/reset coils, motor M, general electromagnetic coil X, etc. per coil operating switch as shown on the right.

## Examples of built-in diode applied circuit

- With the DC-coil Latching Relay, the built-in diode(s) can be used for surge absorption. In this case, pay attention to the polarity of the coil. Note that the 5-minute rating applies only to the set coil rated at 6 VDC and the continuous rating for other DC coil voltages remains unchanged.
- With the AC-coil Latching Relay, a half-wave rectified power supply can be obtained as shown on the right. This can be used as a power supply for light-emitting diodes. However, because of the diode characteristics, the load rating must be 0.5 A or less.

Note: If a smoothing capacitor is used as shown on the right, the waveform of the current that flows into the set or reset coil changes from half wave to that of nearly direct current. In other words, ripple is improved but the coil temperature rises, which may adversely affect the set or reset voltage. Therefore, avoid circuit configuration with an electronic device which improves ripple, such as a capacitor.

## Circuits

Do not allow voltage to be applied simultaneously to both the set and reset coil. If voltage is applied simultaneously, the operation will become unstable.

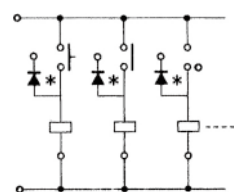

\* Unwanted diodes

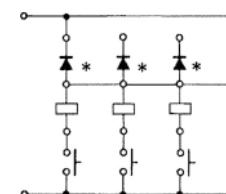

\* Unwanted diodes

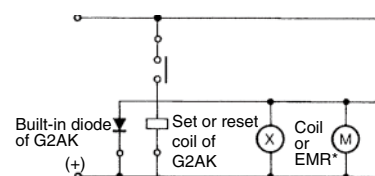
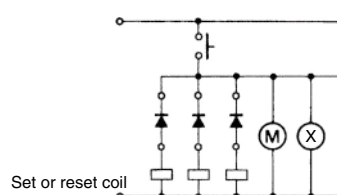

5 (8) 13 (14)

\* EMR: General-purpose electromagnetic relay

The figures above represent the terminal numbers. The figures in parentheses represent the terminals on the set side.

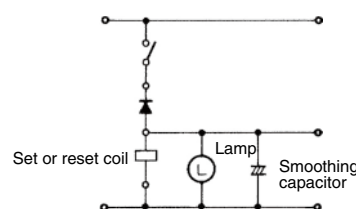
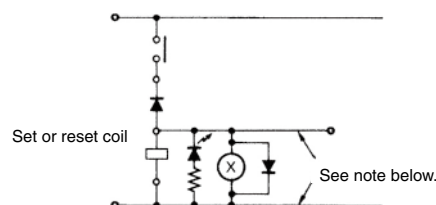

ALL DIMENSIONS SHOWN ARE IN MILLIMETERS.

To convert millimeters into inches, multiply by 0.03937. To convert grams into ounces, multiply by 0.03527.

In the interest of product improvement, specifications are subject to change without notice.

# Safety Precautions for All Relays

---

Refer to the *Safety Precautions* section for each Relay for specific precautions applicable to that Relay.

## ■ Precautions for Safe Use

### Observe the following precautions to ensure safety.

- Do not touch the terminal section (charged section) of the Relay or Socket while power is being supplied. Electric shock may occur.
- Never use a Relay for a load that exceeds the contact ratings of the Relay, such as the switching capacity. Doing so may result in reducing Relay performance for insulation failure, contact welding, and contact faults, and might even result in burning or other damage to the Relay itself.
- Do not drop the Relay or dismantle it. Doing so may reduce Relay performance and might even result in burning or other damage to the Relay itself.
- Relay durability is greatly affected by the switching conditions. Always test the Relay under actual application conditions to confirm applicability and use the Relay only for the number of switching operations that will not affect performance. Continued application of a Relay with reduced performance may result in insulation failure between circuits or in burning in the Relay itself.
- Do not apply an overvoltage or incorrect voltage to the coil, and do not wire the terminals incorrectly. Incorrect application may prevent the Relay from performing its designed function, may affect external circuits, and may even result in burning or other damage to the Relay itself.
- Do not use the Relay in atmospheres containing inflammable or explosive gases. Switching arcs or Relay heating may result in fire or explosion.
- Wire the Relay correctly according to the *Precautions for Correct Use* when performing wiring or soldering. If the Relay is used with wiring or soldering that is defective, abnormal heating while power is supplied may result in burning.

## Relay Application

- Before actually using the Relay, perform all possible tests to confirm applicability. Unexpected trouble can occur in actual operation that would not be anticipated in theoretical planning.
- Unless otherwise specified, all ratings and performances given in this catalog are for JIS C5442 standard test conditions (temperature: 15 to 35°C, humidity: 25% to 75%, pressure: 86 to 106 kPa). When testing the Relay in the actual application, use the operating environment that will exist in actual applications along with the actual load conditions.
- All reference data provided in this catalog are from measurement samples taken from production lines and represented in graph form. Actual values will depend on the application.
- All ratings and performances given in this catalog are from independent tests. Values will vary for different combinations of ratings and performances.

## ■ Precautions for Correct Use

Refer to *Technical Guide for General-purpose Relays*.

In the interest of product improvement, specifications are subject to change without notice.

## Read and Understand This Catalog

Please read and understand this catalog before purchasing the products. Please consult your OMRON representative if you have any questions or comments.

## Warranty and Limitations of Liability

### WARRANTY

OMRON's exclusive warranty is that the products are free from defects in materials and workmanship for a period of one year (or other period if specified) from date of sale by OMRON.

OMRON MAKES NO WARRANTY OR REPRESENTATION, EXPRESS OR IMPLIED, REGARDING NON-INFRINGEMENT, MERCHANTABILITY, OR FITNESS FOR PARTICULAR PURPOSE OF THE PRODUCTS. ANY BUYER OR USER ACKNOWLEDGES THAT THE BUYER OR USER ALONE HAS DETERMINED THAT THE PRODUCTS WILL SUITABLY MEET THE REQUIREMENTS OF THEIR INTENDED USE. OMRON DISCLAIMS ALL OTHER WARRANTIES, EXPRESS OR IMPLIED.

### LIMITATIONS OF LIABILITY

OMRON SHALL NOT BE RESPONSIBLE FOR SPECIAL, INDIRECT, OR CONSEQUENTIAL DAMAGES, LOSS OF PROFITS, OR COMMERCIAL LOSS IN ANY WAY CONNECTED WITH THE PRODUCTS, WHETHER SUCH CLAIM IS BASED ON CONTRACT, WARRANTY, NEGLIGENCE, OR STRICT LIABILITY.

In no event shall responsibility of OMRON for any act exceed the individual price of the product on which liability is asserted.

IN NO EVENT SHALL OMRON BE RESPONSIBLE FOR WARRANTY, REPAIR, OR OTHER CLAIMS REGARDING THE PRODUCTS UNLESS OMRON'S ANALYSIS CONFIRMS THAT THE PRODUCTS WERE PROPERLY HANDLED, STORED, INSTALLED, AND MAINTAINED AND NOT SUBJECT TO CONTAMINATION, ABUSE, MISUSE, OR INAPPROPRIATE MODIFICATION OR REPAIR.

## Application Considerations

### SUITABILITY FOR USE

OMRON shall not be responsible for conformity with any standards, codes, or regulations that apply to the combination of products in the customer's application or use of the product.

At the customer's request, OMRON will provide applicable third party certification documents identifying ratings and limitations of use that apply to the products. This information by itself is not sufficient for a complete determination of the suitability of the products in combination with the end product, machine, system, or other application or use.

The following are some examples of applications for which particular attention must be given. This is not intended to be an exhaustive list of all possible uses of the products, nor is it intended to imply that the uses listed may be suitable for the products:

- Outdoor use, uses involving potential chemical contamination or electrical interference, or conditions or uses not described in this catalog.
- Nuclear energy control systems, combustion systems, railroad systems, aviation systems, medical equipment, amusement machines, vehicles, safety equipment, and installations subject to separate industry or government regulations.
- Systems, machines, and equipment that could present a risk to life or property.

Please know and observe all prohibitions of use applicable to the products.

NEVER USE THE PRODUCTS FOR AN APPLICATION INVOLVING SERIOUS RISK TO LIFE OR PROPERTY WITHOUT ENSURING THAT THE SYSTEM AS A WHOLE HAS BEEN DESIGNED TO ADDRESS THE RISKS, AND THAT THE OMRON PRODUCT IS PROPERLY RATED AND INSTALLED FOR THE INTENDED USE WITHIN THE OVERALL EQUIPMENT OR SYSTEM.

## Disclaimers

### CHANGE IN SPECIFICATIONS

Product specifications and accessories may be changed at any time based on improvements and other reasons.

It is our practice to change model numbers when published ratings or features are changed, or when significant construction changes are made. However, some specifications of the product may be changed without any notice. When in doubt, special model numbers may be assigned to fix or establish key specifications for your application on your request. Please consult with your OMRON representative at any time to confirm actual specifications of purchased product.

### DIMENSIONS AND WEIGHTS

Dimensions and weights are nominal and are not to be used for manufacturing purposes, even when tolerances are shown.

### ERRORS AND OMISSIONS

The information in this catalog has been carefully checked and is believed to be accurate; however, no responsibility is assumed for clerical, typographical, or proofreading errors, or omissions.

### PERFORMANCE DATA

Performance data given in this catalog is provided as a guide for the user in determining suitability and does not constitute a warranty. It may represent the result of OMRON's test conditions, and the users must correlate it to actual application requirements. Actual performance is subject to the OMRON Warranty and Limitations of Liability.

### PROGRAMMABLE PRODUCTS

OMRON shall not be responsible for the user's programming of a programmable product, or any consequence thereof.

### COPYRIGHT AND COPY PERMISSION

This catalog shall not be copied for sales or promotions without permission.

This catalog is protected by copyright and is intended solely for use in conjunction with the product. Please notify us before copying or reproducing this catalog in any manner, for any other purpose. If copying or transmitting this catalog to another, please copy or transmit it in its entirety.