

Click to
ORDER
samples

AM250HB-JZ



1/2 brick

The AM250HB-JZ series is a high-performance half brick DC/DC converter specifically designed for a variety of railway applications. It features 250W of output power with no requirement for minimum load, a wide input voltage of 43-160VDC, operating temperature up to 100°C and reinforced I/O isolation of 3000VAC.

Additionally, this series features include input under-voltage protection, output over-voltage, short-circuit, over-current and over-temperature protection, remote On/Off control, remote sense compensation and output voltage trim adjustment.

The AM250HB-JZ meets EN50155 railway standards and are widely used in the centralized lighting, air conditioning and related on-board equipment.

Features



- Operating Temp: -40 °C to +100 °C
- Isolation voltage: 3000VAC
- High efficiency: Up to 90% typ.
- Regulated single output
- Output short circuit, over-current, over-voltage, input under-voltage, over temperature protection
- Standard 1/2 brick package
- Design to meet EN50155



Summary

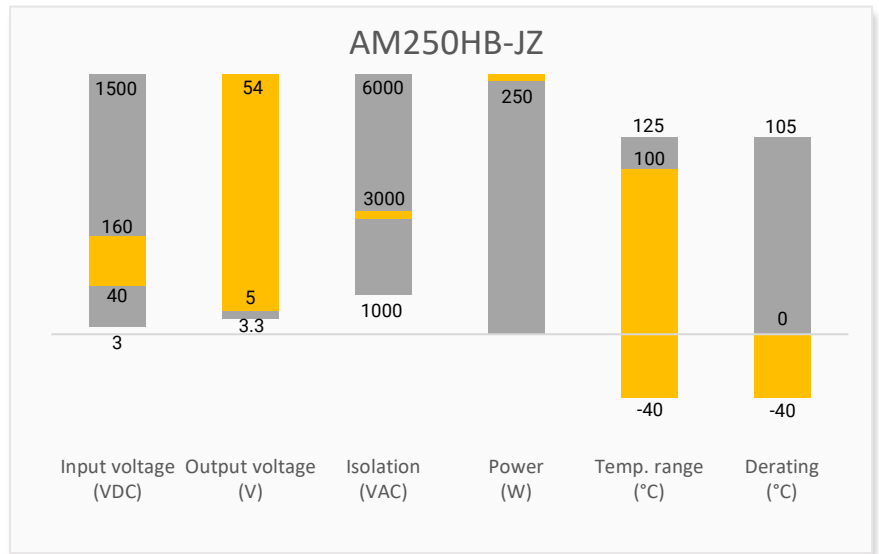

Training

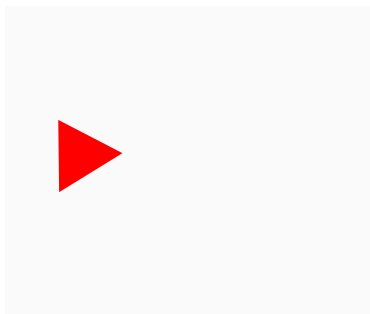

Product Training Video
(click to open)

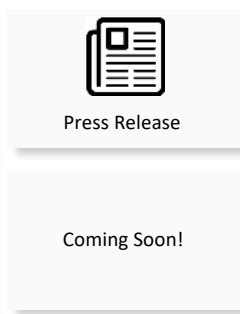

Application Notes

Applications



Railway



Industrial

Models & Specifications

Single Output							
Model	Input Voltage (VDC)	Output Voltage (VDC)	Nominal Vin Input Current Max (mA)		Output Current Max (A)	Maximum Capacitive Load (μF)	Efficiency Full Load Typ (%)
			No Load	Full Load			
AM250HB-11005SA30JZ	40-160	5	70	2582	40	22000	88
AM250HB-11012SA30JZ	40-66	12	70	2582	16,6	10000	90
	66-160				20,8		
AM250HB-11015SA30JZ	40-66	15	70	2582	13,3	6800	90
	66-160				16,6		
AM250HB-11024SA30JZ	40-66	24	70	2582	8,3	4000	90
	66-160				10,4		
AM250HB-11048SA30JZ	40-66	48	70	2582	4,1	680	90
	66-160				5,2		
AM250HB-11054SA30JZ	40-66	54	70	2582	3,7	680	90
	66-160				4,6		

Add suffix "-K" for optional heat sink.

Input Specification				
Parameters	Conditions	Typical	Maximum	Units
Input voltage	Nominal 110V	40 - 160	170	VDC
Absolute maximum rating	1s max.	≥0.7	185	VDC
Start-up voltage			40	VDC
Start-up time		40	100	ms
Shut down voltage		36		VDC
Input reflected current	Nominal 110V	100		mA
On/Off control	On	Control pin open or 3.5-12VDC		
	Off	Control pin short to -Vin or 0-1.2VDC		
Input filter	Idle current	5	10	mA
		Pi filter		

Isolation Specification				
Parameters	Conditions	Typical	Maximum	Units
Tested isolation voltage	Input / output 60 sec, ≤ 5mA	≥3000		VAC
	Input / case 60 sec, ≤ 5mA	≥1500		VAC
	Output / case 60 sec, ≤ 5mA	≥1500		VAC
Resistance	500VDC	≥100		MΩ
Capacitance	100KHz / 0.1V	1000		pF

Output Specification				
Parameters	Conditions	Typical	Maximum	Units
Voltage accuracy		±1	±3	%
Line regulation	LL – HL 100% load	±0.2	±0.5	%
Load regulation	Nominal input, 0% - 100% load, 5V output	±0.8	±1.0	%
	Nominal input, 0% - 100% load, others	±0.4	±0.5	%
Short circuit protection		Continues, Auto recovery		

Over current protection		140	150	% Io
Over voltage protection		130	160	% Vo
Transient Recovery Time	Nominal input, 25% load step change	200	500	μs
Transient Response Deviation	Nominal input, 25% load step change	±3	±5	%
Ripple & Noise*	20MHz bandwidth, 0% -100% load	120	200	mV pk-pk
Trim			±10	%
Sense compensation			5	%

* Tested with the ripple & noise circuit.

General Specifications				
Parameters	Conditions	Typical	Maximum	Units
Switching frequency		260		KHz
Operating temperature	With derating	-40 to +100		°C
Storage temperature		-55 to +125		°C
Over temperature protection	Case temperature		105	°C
Soldering temperature	1.5mm distance, ≤ 10s		300	°C
Temperature coefficient	100% Load		± 0.03	%/°C
Cooling	Free air convection, force air convection			
Humidity	Non-condensing	≥5	95	% RH
Weight	Pin mountable	135		g
	With optional -K heatsink	185		g
Dimensions (L x W x H)	Pin mountable	2.40 x 2.28 x 0.54 inches (61.0 x 57.9 x 13.8 mm)		
	With optional -K heatsink	2.44 x 2.28 x 1.25 inches (62.0 x 58.0 x 31.8 mm)		
Case material	Aluminum case, black plastic bottom (UL94V-0)			
MTBF	≥ 250 000 hrs (MIL-HDBK -217F, t=+25°C)			

NOTE: All specifications in this datasheet are measured at an ambient temperature of 25°C, humidity<75%, nominal input voltage and at rated output load unless otherwise specified.

Safety Specifications		
Parameters		
Standards	Design to meet EN50155	
	EMI - Conducted and radiated emission	CISPR32/EN55032 Class A with the recommended EMC circuit
		EN50121-3-2 with the recommended EMC circuit
		EN55016-2-1 with the recommended EMC circuit
	Electrostatic Discharge Immunity	IEC/EN 61000-4-2, Contact ±6KV, Air ±8KV, Criteria A
		EN50121-3-2, Contact ±6KV, Air ±8KV, Criteria A
	RF, Electromagnetic Field Immunity	IEC/EN 61000-4-3, 20V/m, Criteria A
		EN50121-3-2, 20V/m, Criteria A
	Electrical Fast Transient/Burst Immunity	IEC/EN 61000-4-4, ±2KV, Criteria A with the recommended EMC circuit
		EN50121-3-2, ±2KV, Criteria A with the recommended EMC circuit
Surge Immunity	IEC/EN 61000-4-5, L-L ±2KV, Criteria A with the recommended EMC circuit	
	EN50121-3-2, L-L ±1KV, Criteria A with the recommended EMC circuit	
RF, Conducted Disturbance Immunity	IEC/EN 61000-4-6, 10Vr.m.s, Criteria A	
	EN50121-3-2, 10Vr.m.s, Criteria A	

Derating

AM250HB-11005SA30JZ-K

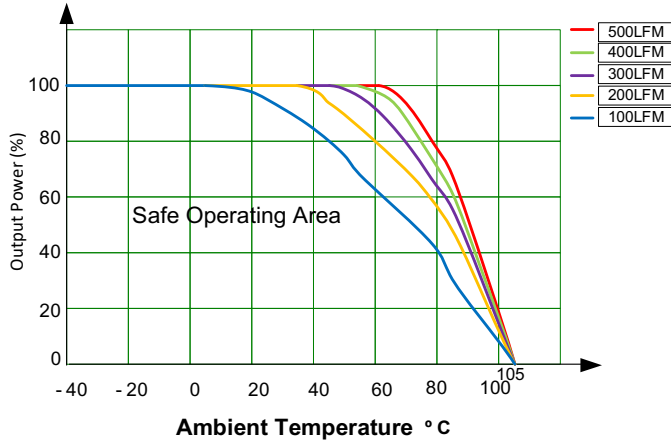

AM250HB-11012SA30JZ-K

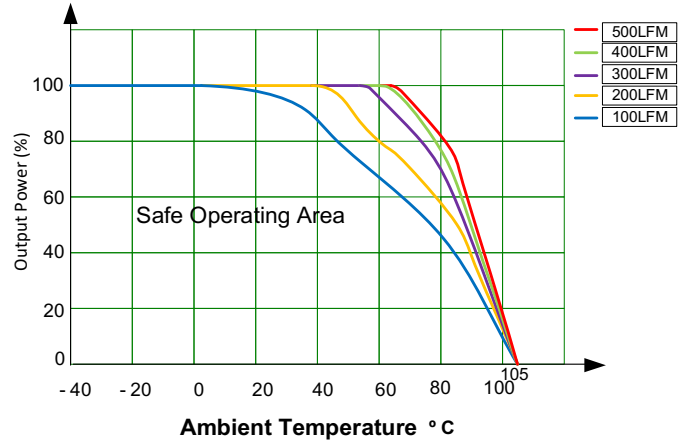

AM250HB-11015SA30JZ-K

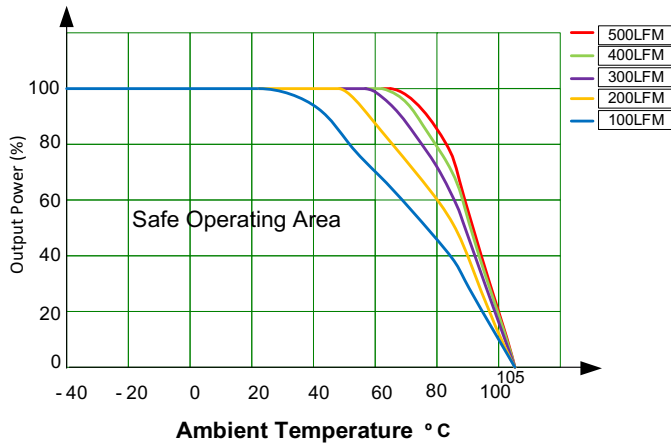

AM250HB-11024SA30JZ-K

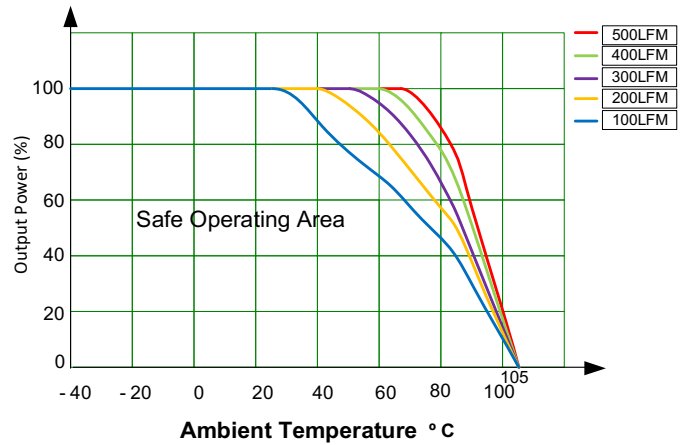

AM250HB-11048SA30JZ-K

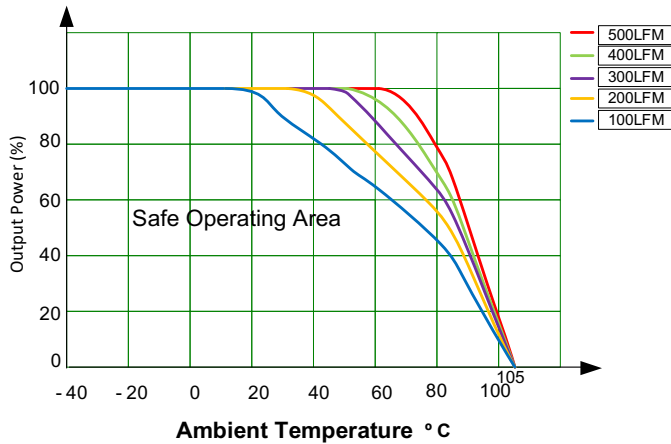

AM250HB-11054SA30JZ-K

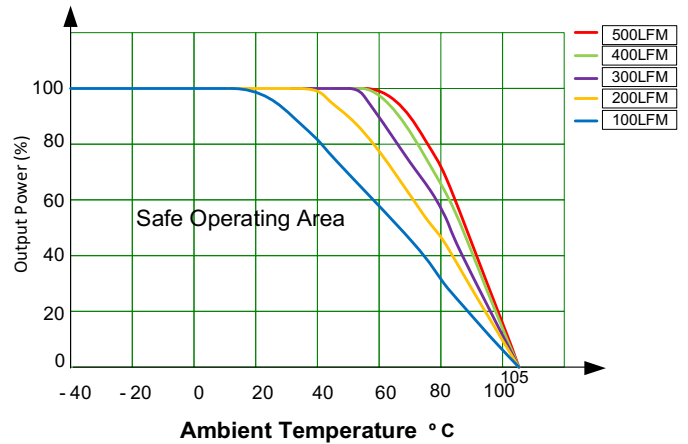

Typical application circuit

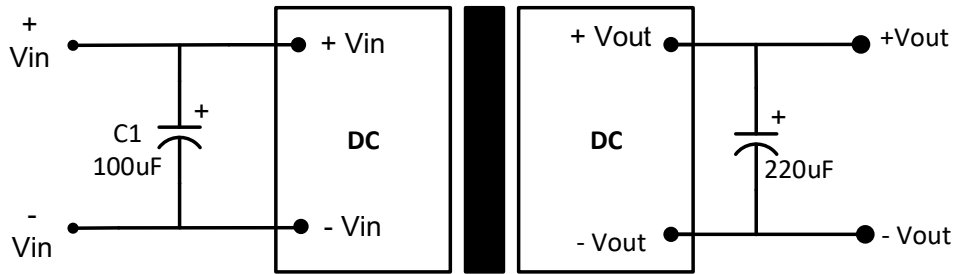

- Note:
1. When not using the sense function, connect the +sense to +Vout and -sense to -Vout with the shortest possible traces to avoid interference and minimize the voltage drop.
 2. When using the sense function, connect the sense pins to the load with the shortest possible traces, twisted pair wire or shielded wire and make sure the voltage drop is less than 0.3V.

Ripple & noise circuit

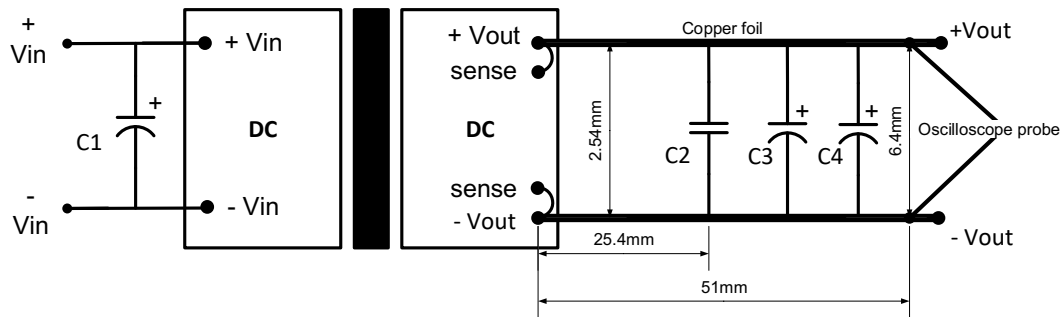

Vout	C1	C2	C3	C4
5	100μF/≥200V electrolytic capacitor	1μF/50V ceramic capacitor	10μF/35V tantalum capacitor	220μF/35V electrolytic capacitor
12	100μF/≥200V electrolytic capacitor	1μF/50V ceramic capacitor	10μF/35V tantalum capacitor	220μF/35V electrolytic capacitor
15	100μF/≥200V electrolytic capacitor	1μF/50V ceramic capacitor	10μF/35V tantalum capacitor	220μF/35V electrolytic capacitor
24	100μF/≥200V electrolytic capacitor	1μF/50V ceramic capacitor	10μF/35V tantalum capacitor	220μF/35V electrolytic capacitor
48	100μF/≥200V electrolytic capacitor	1μF/100V ceramic capacitor	-	220μF/100V electrolytic capacitor
54	100μF/≥200V electrolytic capacitor	1μF/100V ceramic capacitor	-	220μF/100V electrolytic capacitor

Recommended EMC circuit

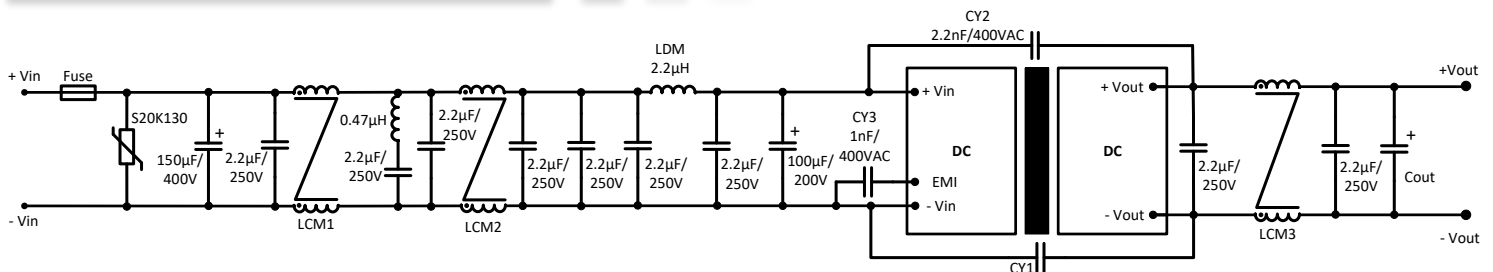

Vout	LCM1	LCM2	LCM3	CY1	Cout
5	220μH	9.5mH	TDG Core TN40H 3.3μH Ø2.0mm*3/3T	1nF/400VAC	220μF/35V electrolytic capacitor
12/15/24/48/54	9.5mH	220μH	TDG Core TN100B 89μH Ø1.0mm*10/10T	2.2nF/400VAC	220μF/63V electrolytic capacitor

Dimension

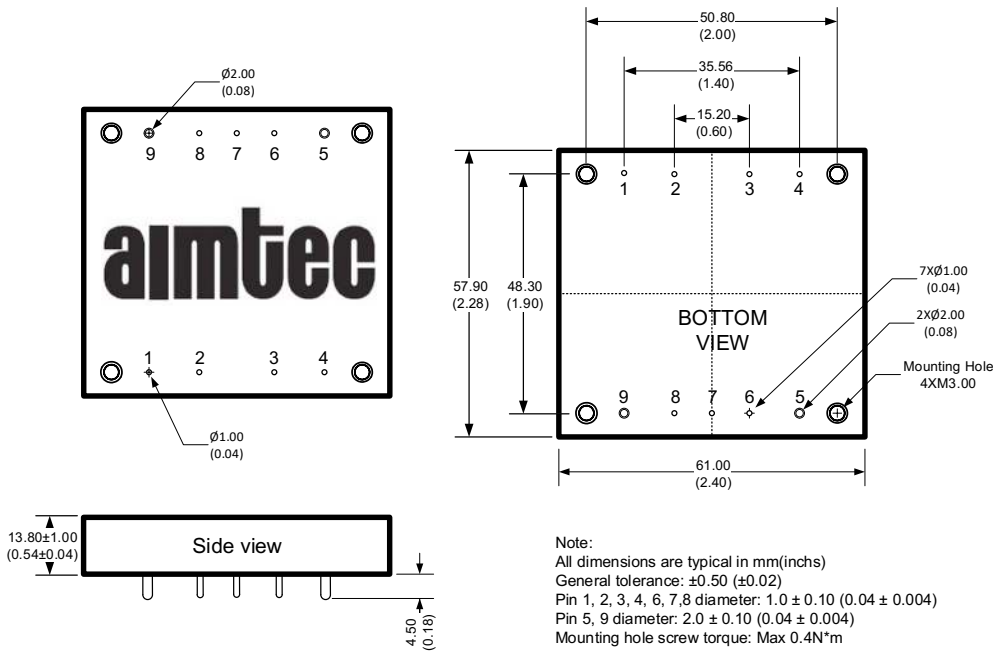

Pin Out Specifications	
Pin	Single
1	+Vin
2	On/Off Control
3	EMI
4	-Vin
5	-Vout
6	-Sense
7	Trim
8	+Sense
9	+Vout

Dimension for models with -K option

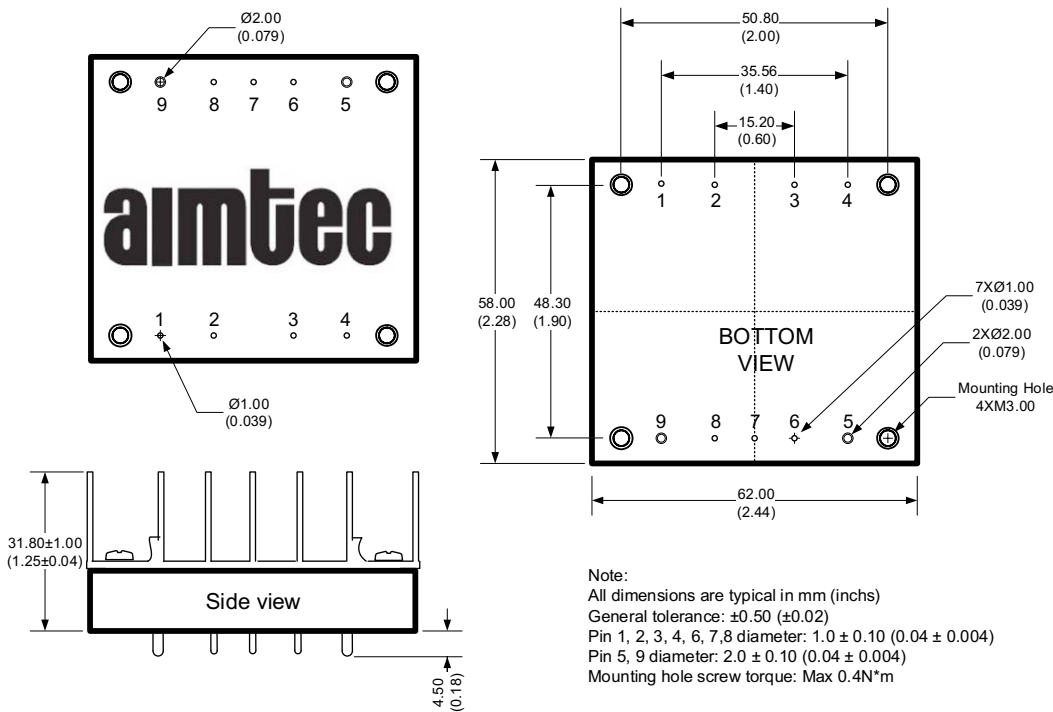

Trim

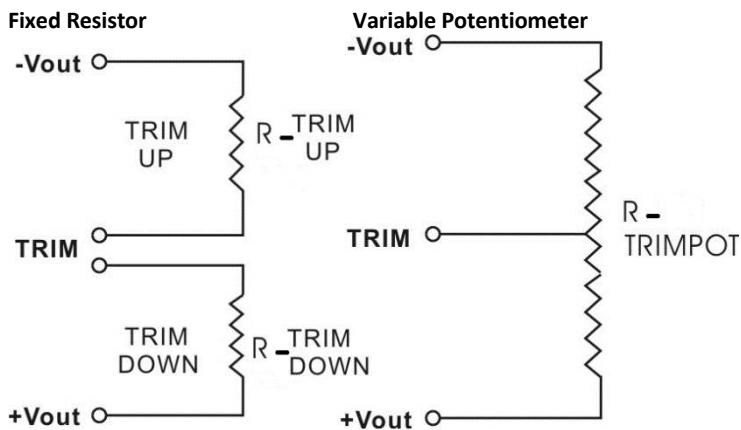

Vout = 5V

Trim down %	1	2	3	4	5	6	7	8	9	10
Vout (VDC)	4.95	4.9	4.85	4.8	4.75	4.7	4.65	4.6	4.55	4.5
Rt down (KΩ)	73.886	40.617	25.481	16.829	11.229	7.308	4.41	2.18	0.412	-1.025
Trim up %	1	2	3	4	5	6	7	8	9	10
Vout (VDC)	5.05	5.1	5.15	5.2	5.25	5.3	5.35	5.4	5.45	5.5
Rt up (KΩ)	428.655	97.5	50.518	31.747	21.646	15.334	11.016	7.877	5.491	3.616

Vout = 12V

Trim down %	1	2	3	4	5	6	7	8	9	10
Vout (VDC)	11.88	11.76	11.64	11.52	11.4	11.28	11.16	11.04	10.92	10.8
Rt down (KΩ)	563.093	324.521	223.02	166.823	131.132	106.455	88.375	74.559	63.657	54.836
Trim up %	1	2	3	4	5	6	7	8	9	10
Vout (VDC)	12.12	12.24	12.36	12.48	12.6	12.72	12.84	12.96	13.08	13.2
Rt up (KΩ)	422.855	132.763	72.993	47.192	32.81	23.64	17.283	12.617	9.047	6.226

Vout = 15V

Trim down %	1	2	3	4	5	6	7	8	9	10
Vout (VDC)	14.85	14.7	14.55	14.4	14.25	14.1	13.95	13.8	13.65	13.5
Rt down (KΩ)	720.664	431.486	302.456	229.388	182.362	149.563	125.381	106.816	92.114	80.183
Trim up %	1	2	3	4	5	6	7	8	9	10
Vout (VDC)	15.15	15.3	15.45	15.6	15.75	15.9	16.05	16.2	16.35	16.5
Rt up (KΩ)	600.19	153.566	80.902	51.125	34.919	24.727	17.726	12.62	8.731	5.671

Vout = 24V

Trim down %	1	2	3	4	5	6	7	8	9	10
Vout (VDC)	23.76	23.52	23.28	23.04	22.8	22.56	22.32	22.08	21.84	21.6
Rt down (KΩ)	1467.923	858.167	598.747	455.114	363.892	300.821	254.612	219.3	191.437	168.89
Trim up %	1	2	3	4	5	6	7	8	9	10
Vout (VDC)	24.24	24.48	24.72	24.96	25.2	25.44	25.68	25.92	26.16	26.4
Rt up (KΩ)	478.141	150.205	82.637	53.471	37.213	26.846	19.66	14.385	10.349	7.161

Vout = 48V

Trim down %	1	2	3	4	5	6	7	8	9	10
Vout (VDC)	47.52	47.04	46.56	46.08	45.6	45.12	44.64	44.16	43.68	43.2
Rt down (KΩ)	4441.411	2418.061	1646.022	1238.671	986.977	816.031	692.348	598.707	525.348	466.325
Trim up %	1	2	3	4	5	6	7	8	9	10
Vout (VDC)	48.48	48.96	49.44	49.92	50.4	50.88	51.36	51.84	52.32	52.8
Rt up (KΩ)	378.242	152.741	90.29	61.005	44.008	32.907	25.088	19.282	14.801	11.237

Vout = 54V

Trim down %	1	2	3	4	5	6	7	8	9	10
Vout (VDC)	53.46	52.92	52.38	51.84	51.3	50.76	50.22	49.68	49.14	48.6
Rt down (KΩ)	3582.604	2166.061	1539.922	1186.947	960.388	802.646	686.501	597.415	526.92	469.745
Trim up %	1	2	3	4	5	6	7	8	9	10
Vout (VDC)	54.54	55.08	55.62	56.16	56.7	57.24	57.78	58.32	58.86	59.4
Rt up (KΩ)	654.054	179.463	97.803	63.958	45.442	33.764	25.727	19.858	15.383	11.859

NOTE: **1.** Datasheets are updated as needed and as such, specifications are subject to change without notice. Once printed or downloaded, datasheets are no longer controlled by Aimtec; refer to www.aimtec.com for the most current product specifications. **2.** Product labels shown, including safety agency certifications on labels, may vary based on the date manufactured. **3.** Mechanical drawings and specifications are for reference only. **4.** All specifications are measured at an ambient temperature of 25°C, humidity<75%, nominal input voltage and at rated output load unless otherwise specified. **5.** Aimtec may not have conducted destructive testing or chemical analysis on all internal components and chemicals at the time of publishing this document. CAS numbers and other limited information are considered proprietary and may not be available for release. **6.** This product is not designed for use in critical life support systems, equipment used in hazardous environments, nuclear control systems or other such applications which necessitate specific safety and regulatory standards other the ones listed in this datasheet. **7.** Warranty is in accordance with Aimtec's standard Terms of Sale available at www.aimtec.com.