



TSD305-1C55

DIGITAL TEMPERATURE SENSOR

Product Description

The TSD is a contactless temperature measurement system located in a TO5 package. The TSD includes an infrared sensor (thermopile) and a sensor signal conditioner.

The TSD can be interfaced to any microcontroller by an I²C interface. This microcontroller has to calculate the temperature results based on the ADC values and the calibration parameters

Features

- 0°C ... +100°C measurement range
- Small size
- Up to ±1°C accuracy
- I²C Interface
- Low current consumption
- Operating Temperature Range: -10°C ... +85°C

Applications

- Contactless temperature measurement
- Climate control
- Industrial process control
- Household applications

ABSOLUTE MAXIMUM RATINGS

Absolute maximum ratings are limiting values of permitted operation and should never be exceeded under the worst possible conditions either initially or consequently. If exceeded by even the smallest amount, instantaneous catastrophic failure can occur. Even if the device continues to operate satisfactorily, its life may be considerably shortened.

Parameter	Symbol	Condition	Min	Typ	Max	Unit
Supply voltage	V_{DD}	---	-0.3	---	+3.63	V
Storage temperature	T_{stor}	dry	-20	---	+85	°C
Voltage at supply and IO pins	V_{DD} V_{IO}	---	-0.5	---	$V_{DD} + 0.5$	V
Current into supply and IO pins	I_{IN}	---	-100	---	100	mA
ESD rating	ESD	Human Body Model	-2	---	+2	kV
Humidity	Hum	---	Non condensing			---

OPERATING CONDITIONS

If not otherwise noted, 3.3V supply voltage is applied.

Parameter	Symbol	Condition	Min	Typ	Max	Unit
Operating supply voltage	V_{DD}	stabilized, 100nF	1.68	---	3.6	V
VDD rise time	t_{VDD}	---	---	---	200	μs
Operating temperature	T_{op}	---	-20	---	+85	°C
Object temperature range	T_{OBJ}	---	0	---	+100	°C
Resolution	RES	---	---	---	0.1	°C
Supply Current	I_{VDD}	Active state, average	---	1050	1500	μA
		Sleep state, idle current	---	20	25	nA
Serial data clock I2C	F_{SCL}	---	---	---	3.4	MHz
Self heating	SH	1 sample/s, still air, 60s	---	---	+0.2	°C
VDD capacitor	C_{VDD}	Place close to the sensor	---	100	---	nF

THERMOPILE COMPONENT

If not otherwise noted, 3.3V supply voltage is applied.

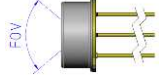
Parameter	Symbol	Condition	Min	Typ	Max	Unit
Absorber area	A	---	0.8 x 0.8			mm
Field of view	FOV	At 50% of maximum signal 	---	88	---	deg
Filter transmission range	LWP	Long wave pass	>5.5			μm

ANALOGUE TO DIGITAL CONVERTER

Parameter	Symbol	Condition	Min	Typ	Max	Unit
Resolution	ADC _{RES}	---	---	16	---	bit
Conversion time	t _{CONV}	---	---	44.8	59.2	ms
Rise time	t ₆₃	Including rise time of sensor element	---	---	44.8	ms
Resolution internal temperature sensor	ITS _{RES}	---	---	0.003	---	K/LSB

TOLERANCES

If not otherwise noted, 3.3V supply voltage is applied.

T_{sen} = sensor temperature, T_{obj} = object temperature

Parameter	Symbol	Sensor Tempo	Object Temp	Max	Unit
Accuracy Standard Temp ¹⁾	ACC _S	+15°C < T _{sen} < +35°C	+40°C < T _{obj} < +80°C	±1	°C
Accuracy Extended Temp. 1 ²⁾	ACC _{E1}	Complete range	+40°C < T _{obj} < +80°C	±2	°C
		+15°C < T _{sen} < +35°C	Complete range		
Accuracy Extended Temp. 2 ²⁾	ACC _{E3}	Complete range	Complete range	±3	°C

Other temperature ranges and accuracies are available on request.

¹⁾ Proved while production

²⁾ Proved by design

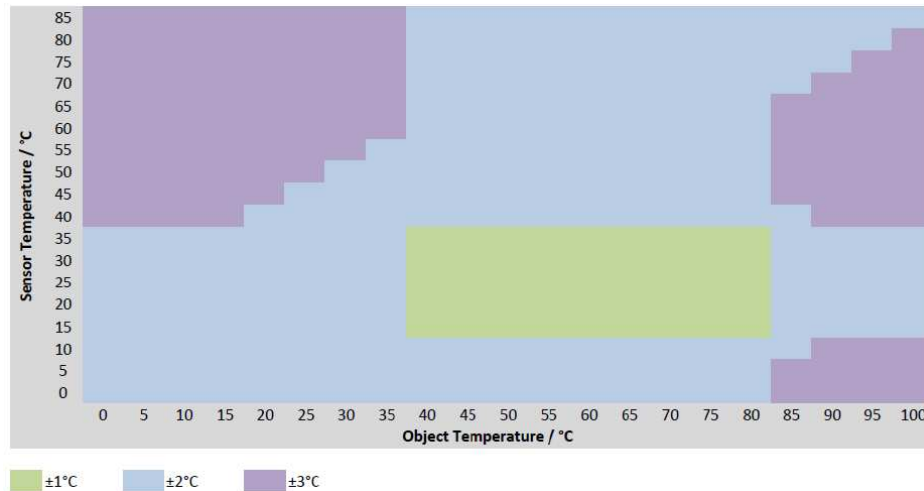

Typical accuracy performance

TSD305-1C55

Digital Thermopile Sensor

POWER & RESET

Parameter	Symbol	Condition	Min	Typ	Max	Unit
Start up time	t_{STA1}	V_{DD} ramp up to interface communication	---	---	1	ms
	t_{STA2}	V_{DD} ramp to first ADC measurement	---	---	2.5	ms
Wake up time	t_{WUP1}	Sleep to active state interface communication	---	---	0.5	ms
	t_{WUP2}	Sleep to first ADC measurement	---	---	2	ms
Power down time for reset	t_{RESET}	$V_{DD_{low}}$	3	---	---	μ s
VDD low level	$V_{DD_{low}}$	---	0	---	0.2	V
VDD rising slope	SR_{VDD}	---	10	---	---	V/ms

DIMENSIONS

If not specified, all tolerances according DIN ISO 2768-m.

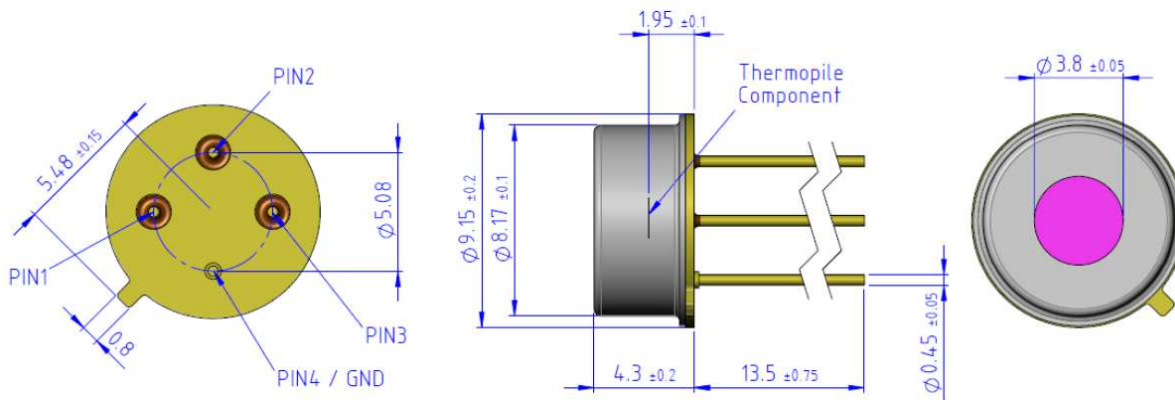

PIN FUNCTION TABLE

Pin	Name	Type	Function
1	SCL	DI	I ² C Clock
2	SDA	DIO	I ² C Data
3	V_{DD}	P	Supply Voltage
4	V_{SS}	P	Ground

I²C INTERFACE

An I²C communication message starts with a start condition and it is ended by a stop condition.

Most commands consist of two bytes: the address byte and command byte.

I²C ADDRESS

The standard I²C address is 0x00 (0b0000000X).

- X = 0: I²C Write
- X = 1: I²C Read

STATUS BYTE

Each return starts with a status byte followed by the requested data word.

Bit	7	6	5	4	3	2	1	0
Meaning	---	---	Busy	---	---	Memory Error	---	---

- Busy: 1 = Sensor is busy. The requested data is not available yet.
- Memory Error: 1 = Memory integrity check failed. Memory was changed after factory calibration.

COMMANDS

Note: Each return starts with a status byte followed by the requested data word.

Command	Return	Description
0x00 ... 0x39	16 bit EEPROM data	Read data from EEPROM address (0x00 ... 0x39) matching the command
0xAF	24 bit object temperature ADC, 24 bit sensor temperature ADC	Measure object temperature and sensor temperature ADC 16 times and calculates mean value. Store data in output buffer.

Read EEPROM

Write Command:



Read EEPROM Data:

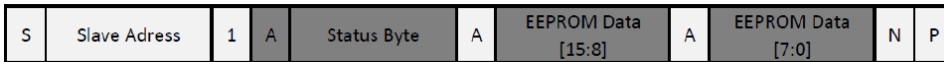

Perform Measurement and Read ADC Data

Write Command:

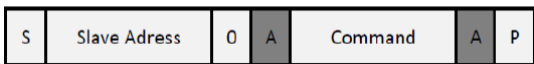

Read ADC Data:

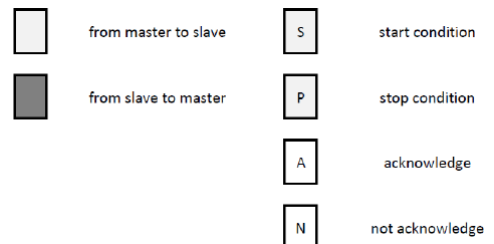

EEPROM CONTENT

Adress / hex	Adress / dec	Description	Name	Format	Example	
					Content	Value
0x00	0	Lot Nr.	---	UINT16	15001	YY WWW
0x01	1	Serial Number	---	UINT16	12345	Number
0x02 ... 0x19	2 ... 25	Factory Calibration Data	---	---	---	---
0x1A	26	Min. Sensor Temp. / °C	T _{SenMin}	SINT16	0xFFEC	-20°C
0x1B	27	Max. Sensor Temp. / °C	T _{SenMax}	SINT16	0x0055	+85°C
0x1C	28	Min. Object Temp. / °C	T _{ObjMin}	SINT16	0x0000	0°C
0x1D	29	Max. Object Temp. / °C	T _{ObjMax}	SINT16	0x0064	100°C
0x1E	30	Temperature Coefficient	TC	IEEE 754 H-Word	0xBB96	-0.0046
0x1F	31			IEEE 754 L-Word	0xBB99	
0x20	32	Reference Temperature	T _{REF}	IEEE 754 H-Word	0x41D7	26.93
0x21	33			IEEE 754 L-Word	0x70A4	
0x22	34	Compensation Coefficient k4	k4 _{comp}	IEEE 754 H-Word	0x3A07	5.161E-04
0x23	35			IEEE 754 L-Word	0x4C8C	
0x24	36	Compensation Coefficient k3	k3 _{comp}	IEEE 754 H-Word	0x3F10	5.639E-01
0x25	37			IEEE 754 L-Word	0x5CEC	
0x26	38	Compensation Coefficient k2	k2 _{comp}	IEEE 754 H-Word	0x4367	2.311E+02
0x27	39			IEEE 754 L-Word	0x0D1F	
0x28	40	Compensation Coefficient k1	k1 _{comp}	IEEE 754 H-Word	0x4724	4.207E+04
0x29	41			IEEE 754 L-Word	0x5A6F	
0x2A	42	Compensation Coefficient k0	k0 _{comp}	IEEE 754 H-Word	0xC9A0	-1.312E+06
0x2B	43			IEEE 754 L-Word	0x254D	
0x2C	44	Not used	---	---	---	---
0x2D	45			---	---	
0x2E	46	ADC → T Coefficient k4	k4 _{Obj}	IEEE 754 H-Word	0x944B	-1.029E-26
0x2F	47			IEEE 754 L-Word	0xD24F	
0x30	48	ADC → T Coefficient k3	k3 _{Obj}	IEEE 754 H-Word	0x2052	1.787E-19
0x31	49			IEEE 754 L-Word	0xF1C2	
0x32	50	ADC → T Coefficient k2	k2 _{Obj}	IEEE 754 H-Word	0xABE5	-1.631E-12
0x33	51			IEEE 754 L-Word	0x991B	
0x34	52	ADC → T Coefficient k1	k1 _{Obj}	IEEE 754 H-Word	0x3797	1.802E-05
0x35	53			IEEE 754 L-Word	0x2BBF	
0x36	54	ADC → T Coefficient k0	k0 _{Obj}	IEEE 754 H-Word	0x41D7	2.693E+01
0x37	55			IEEE 754 L-Word	0x6DBA	
0x38	56	Status	---	UINT16	TBD	---

NUMBER FORMAT

UINT16

- Description: Unsigned integer
- Bits 16
- Min (dec/hec/bin) 0 / 0x0000 / 0b0000 0000 0000 0000
- Max (dec/hec/bin) 65,535 / 0xFFFF / 0b1111 1111 1111 1111

SINT16

- Description: Signed integer
- Bits 16
- Min (dec/hec/bin) - 32,768 / 0x8000 / 0b1000 0000 0000 0000
- Max (dec/hec/bin) 32,767 / 0x7FFF / 0b0111 1111 1111 1111

FLOAT IEEE 754

- Description: Float
- Bits 32
- Min (dec/hec/bin) -1.4E-45 / 0x80000001 / 0b1000 0000 0000 0000 0000 0000 0000 0001
- Max (dec/hec/bin) 3.403E38 / 0x7f800000 / 0b0111 1111 1000 0000 0000 0000 0000 0000
- Example: H-Word 0x3DCC
L-Word 0xCCCC
→ 0b0011 1101 1100 1100 1100 1100 1100 1101
→ 0.1

FLOAT IEEE 754 Conversions

The two integer words can easily be converted to a floating-point number by using a union consisting of an integer array and a float.

```
void main(void)
{
    union
    {
        unsigned int iValue[2];    // 16bit unsigned integer
        float fValue;             // float IEEE 754
    } MyUnion;

    while(1)
    {
        MyUnion.iValue[1] = 0x3dcc;
        MyUnion.iValue[0] = 0xcccd;
        //MyUnion.fValue = 0.1;
    }
}
```

TEMPERATURE CALCULATION

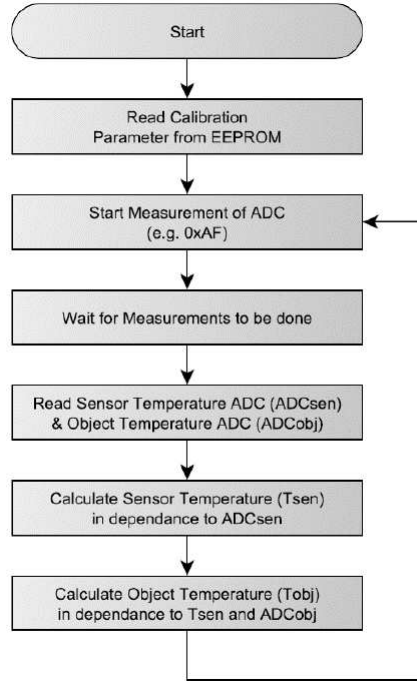

SENSOR TEMPERATURE

The sensor temperature T_{Sen} is calculated from the corresponding 24 bit ADC value ADC_{sen} .

Name	Description	Format	Range	
			Min	Max
ADC_{sen}	ADC Sensor Temperature	INT24	0	16,777,216

ADC_{sen} is scaled to cover the complete sensor temperature range from T_{SenMin} to T_{SenMax} .

Adress / hex	Adress / dec	Description	Name	Format	Example	
					Value	Max
0x1A	26	Min. Sensor Temp. / °C	T_{SenMin}	SINT16	0xFFEC	-20°C
0x1B	27	Max. Sensor Temp. / °C	T_{SenMax}	SINT16	0x0055	+85°C

Formula:

$$T_{\text{Sen}} = \text{ADC}_{\text{sen}} / 2^{24} \times (T_{\text{SenMax}} - T_{\text{SenMin}}) + T_{\text{SenMin}}$$

Example:

$$\text{ADC}_{\text{sen}} = 6,364,157$$

$$T_{\text{Sen}} = 6,364,157 / 224 \times [+85^\circ\text{C} - (-20^\circ\text{C})] + (-20^\circ\text{C}) = \underline{19.83^\circ\text{C}}$$

OBJECT TEMPERATURE

The object temperature T_{obj} is calculated in dependence of the sensor temperature T_{sen} and ADC_{obj} .

ADC_{obj} is shifted by 2^{23} in order to provide unsigned integer values for positive and negative measurement values.

Name	Description	Format	Range	
			Min	Max
ADC_{obj}	ADC Object Temperature Shifted by 2^{23} (0 is represented by 8,388,608)	INT24	0	16,777,216

The process consists of three successive steps.

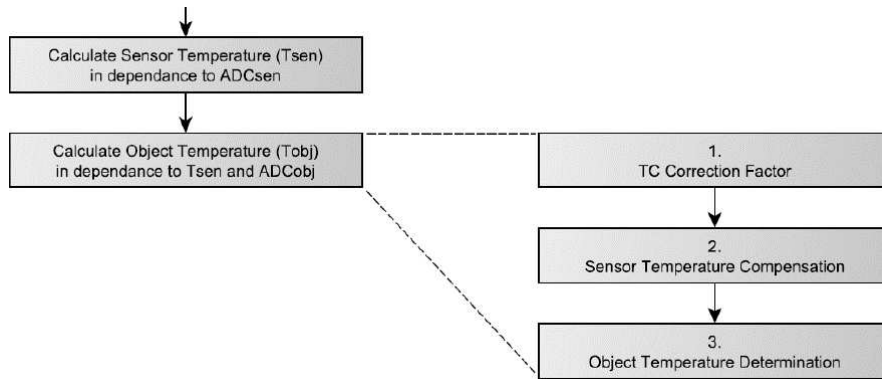

TC Correction Factor

Adress / hex	Adress / dec	Description	Name	Format	Example	
					Content	Value
0x1E	30	Temperature Coefficient	TC	IEEE 754 H-Word	0xBB96	-0.0046
0x1F	31				0xBB99	
0x20	32	Reference Temperature	T_{REF}	IEEE 754 H-Word	0x41D7	+26.93
0x21	33				0x70A4	

Formula:

$$TCF = 1 + [(T_{sen} - T_{ref}) \times TC]$$

Example:

$$T_{sen} = +19.83^{\circ}\text{C}$$

$$T_{ref} = +26.93^{\circ}\text{C}$$

$$TC = -0.0046$$

$$TCF = 1 + [(19.83 - 26.93) \times -0.0046] = \underline{1.0327}$$

Temperature Compensation

Address / hex	Address / dec	Description	Name	Format	Example	
					Content	Value
0x22	34	Compensation Coefficient k4	k4 _{comp}	IEEE 754 H-Word	0x3A07	5.161E-04
0x23	35			IEEE 754 L-Word	0x4C8C	
0x24	36	Compensation Coefficient k3	k3 _{comp}	IEEE 754 H-Word	0x3F10	5.639E-01
0x25	37			IEEE 754 L-Word	0x5CEC	
0x26	38	Compensation Coefficient k2	k2 _{comp}	IEEE 754 H-Word	0x4367	2.311E+02
0x27	39			IEEE 754 L-Word	0x0D1F	
0x28	40	Compensation Coefficient k1	k1 _{comp}	IEEE 754 H-Word	0x4724	4.207E+04
0x29	41			IEEE 754 L-Word	0x5A6F	
0x2A		Compensation Coefficient k0	k0 _{comp}	IEEE 754 H-Word	0xC9A0	-1.312E+06
0x2B				IEEE 754 L-Word	0x254D	

Formula:

$$\text{Offset} = k_{4\text{comp}} \times T_{\text{sen}}^4 + k_{3\text{comp}} \times T_{\text{sen}}^3 + k_{2\text{comp}} \times T_{\text{sen}}^2 + k_{1\text{comp}} \times T_{\text{sen}} + k_{0\text{comp}}$$

$$\text{Offset}_{\text{TC}} = \text{Offset} \times \text{TCF}$$

Example:

$$T_{\text{sen}} = +19.83^{\circ}\text{C}$$

$$k_{4\text{comp}} \dots k_{0\text{comp}} \text{ See table above}$$

$$\begin{aligned} \text{Offset} &= 5.161 \cdot 10^{-4} \times 19.83^4 \\ &+ 5.639 \cdot 10^{-1} \times 19.83^3 \\ &+ 2.311 \cdot 10^2 \times 19.83^2 \\ &+ 4.207 \cdot 10^4 \times 19.83 \\ &+ -1.312 \cdot 10^6 \\ &= -382,399 \end{aligned}$$

$$\begin{aligned} \text{Offset}_{\text{TC}} &= -382,399 \times 1.0327 \\ &= -394,904 \end{aligned}$$

Object Temperature Determination

Address / hex	Address / dec	Description	Name	Format	Example	
					Content	Value
0x2E	46	ADC → T Coefficient k4	k4 _{Obj}	IEEE 754 H-Word	0x944B	-1.029E-26
0x2F	47			IEEE 754 L-Word	0xD24F	
0x30	48	ADC → T Coefficient k3	k3 _{Obj}	IEEE 754 H-Word	0x2052	1.787E-19
0x31	49			IEEE 754 L-Word	0xF1C2	
0x32	50	ADC → T Coefficient k2	k2 _{Obj}	IEEE 754 H-Word	0xABE5	-1.631E-12
0x33	51			IEEE 754 L-Word	0x991B	
0x34	52	ADC → T Coefficient k1	k1 _{Obj}	IEEE 754 H-Word	0x3797	1.802E-05
0x35	53			IEEE 754 L-Word	0x2BBF	
0x36	54	ADC → T Coefficient k0	k0 _{Obj}	IEEE 754 H-Word	0x41D7	2.693E+01
0x37	55			IEEE 754 L-Word	0x6DBA	

Formula:

Example:

$$ADC_{Comp} = Offset_{TC} + ADC_{Obj} - 2^{23}$$

$$ADC_{Obj} = 10,738,758$$

$$k4_{Obj} \dots k0_{Obj} \text{ See table above}$$

$$ADC_{Comp} = -394,904 + 10,738,758 - 8,388,608 = 1,955,246$$

$$ADC_{CompTC} = ADC_{Comp} / TCF$$

$$ADC_{CompTC} = 1,955,246 / 1.0327 = 1,893,334$$

$$T_{Obj} = k4_{Obj} \times ADC_{CompTC}^4 + k3_{Obj} \times ADC_{CompTC}^3 + k2_{Obj} \times ADC_{CompTC}^2 + k1_{Obj} \times ADC_{CompTC} + k0_{Obj}$$

$$T_{Obj} = -1.029 \cdot 10^{-26} \times 1,893,334^4 + 1.787 \cdot 10^{-19} \times 1,893,334^3 + -1.631 \cdot 10^{-12} \times 1,893,334^2 + 1.802 \cdot 10^{-5} \times 1,893,334 + 2.693 \cdot 10 = 56.28^{\circ}C$$

ORDER INFORMATION

Further customer specific adaptations are available on request. Please refer to the table below for part name, description and order information.

Part Number	Part Description	Comment
G-TPMO-101	TSD305-1C55 Digital Thermopile Sensor	TO5, I ² C Interface, 0°C ... +100°C

EMC

Due to the use of these modules for OEM application no CE declaration is done. Especially line coupled disturbances like surge, burst, HF etc. cannot be removed by the module due to the small board area and low price feature. There is no protection circuit against reverse polarity or over voltage implemented. The module will be designed using capacitors for blocking and ground plane areas in order to prevent wireless coupled disturbances as good as possible.

NORTH AMERICA

Measurement Specialties, Inc.,
a TE Connectivity Company
1711 139th Lane NW
Andover, MN 55304
Tel: +1 763 689 4870
Fax: +1 763 689 5033

customercare.ando@te.com

EUROPE

TE Connectivity Sensors Germany GmbH

Hauert 13

44227 Dortmund
Germany

Tel: +49-231-9740-0
Fax: +49-231-9740-20

CustomerCare.dtmd@te.com

ASIA

Measurement Specialties (China), Ltd.,
a TE Connectivity Company
No. 368 Wulian 1st Road
Gongxing Town
Shuangliu, Chengdu
Sichuan, 610200
China

Tel: +86 (0) 28 8573 9088
Fax: +86 (0) 28 8573 9070

customercare.chdu@te.com

ASIA

Measurement S
a TE Connectiv
No. 26, Langsh
High-tech Park
Nanshan Distric
China

Tel: +86-755-3
Fax: +86-755-3
CustomerCare.

te.com/sensorsolutions

Measurement Specialties, Inc., a TE Connectivity company.

Measurement Specialties, MEAS, TE Connectivity, TE Connectivity (logo) and EVERY CONNECTION COUNTS are trademarks. All other logos, products and/or company names referred to herein might be trademarks of their respective owners.

The information given herein, including drawings, illustrations and schematics which are intended for illustration purposes only, is believed to be reliable. However, TE Connectivity makes no warranties as to its accuracy or completeness and disclaims any liability in connection with its use. TE Connectivity's obligations shall only be as set forth in TE Connectivity's Standard Terms and Conditions of Sale for this product and in no case will TE Connectivity be liable for any incidental, indirect or consequential damages arising out of the sale, resale, use or misuse of the product. Users of TE Connectivity products should make their own evaluation to determine the suitability of each such product for the specific application.

© 2016 TE Connectivity Ltd. family of companies All Rights Reserved.