

High and Low Side Driver

Features

- Floating channel designed for bootstrap operation
- Fully operational to +600V
- Tolerant to negative transient voltage
- dV/dt immune
- Gate drive supply range from 10 to 20V
- Undervoltage lockout for both channels
- 3.3V, 5V and 15V input logic compatible
- Matched propagation delay for both channels
- Logic and power ground +/-5V offset
- Lower di/dt gate driver for better noise immunity
- Outputs in phase with inputs

Description

The IR25604 is a high voltage, high speed power MOSFET and IGBT driver with independent high and low side referenced output channels. Proprietary HVIC and latch immune CMOS technologies enable ruggedized monolithic construction. The logic input is compatible with standard CMOS or LSTTL output, down to 3.3V logic. The output drivers feature a high pulse current buffer stage designed for minimum driver cross-conduction. The floating channel can be used to drive an N-channel power MOSFET or IGBT in the high side configuration which operates up to 600 V.

Product Summary

V_{OFFSET}	600V max.
$I_{O+/-}$	200 mA / 350 mA
V_{OUT}	10 – 20V
Ton/off (typ.)	220 & 200 ns

Package Options

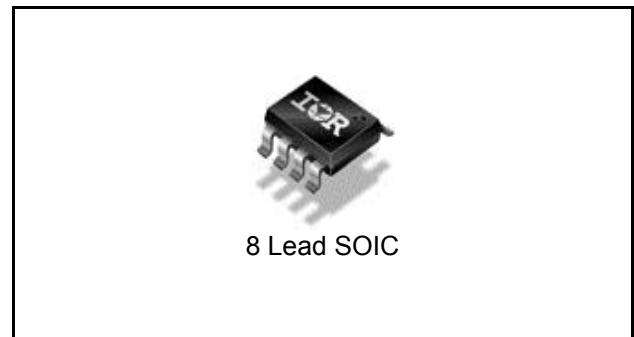

Ordering Information

Base Part Number	Package Type	Standard Pack		Orderable Part Number
		Form	Quantity	
IR25604SPBF	SO8N	Tube	95	IR25604SPBF
IR25604SPBF	SO8N	Tape and Reel	2500	IR25604STRPBF

Typical Connection Diagram

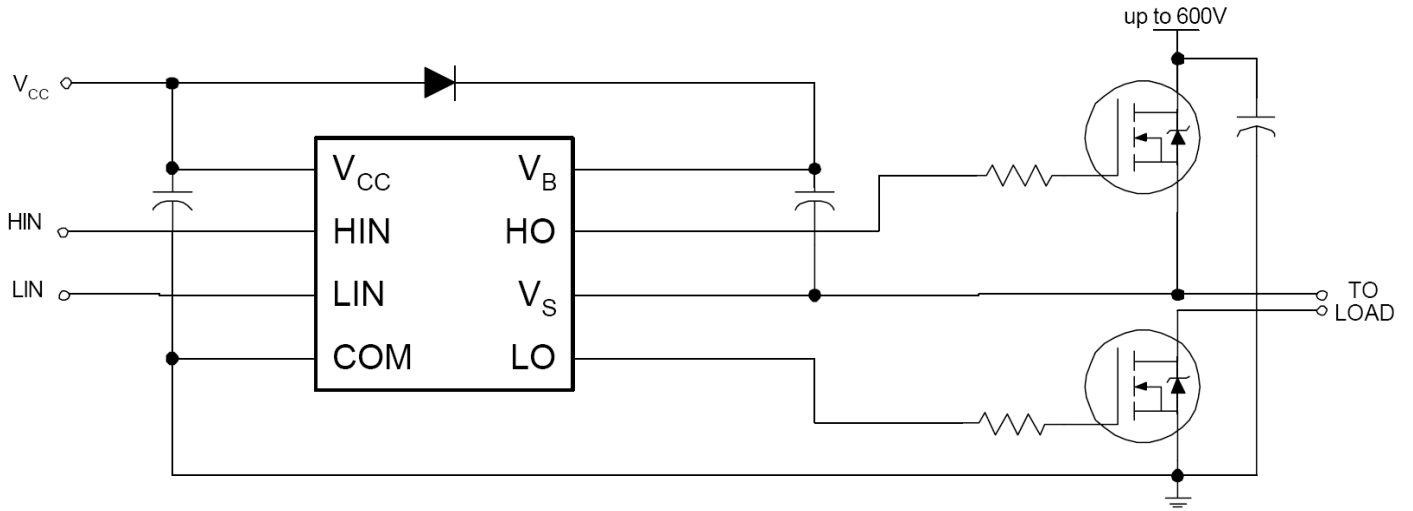

Absolute Maximum Ratings

Absolute maximum ratings indicate sustained limits beyond which damage to the device may occur. All voltage parameters are absolute voltages referenced to COM. The thermal resistance and power dissipation ratings are measured under board mounted and still air conditions.

Symbol	Definition	Min.	Max.	Units
V_B	High side floating absolute voltage	-0.3	625	V
V_S	High side floating supply offset voltage	$V_B - 25$	$V_B + 0.3$	
V_{HO}	High side floating output voltage	$V_S - 0.3$	$V_B + 0.3$	
V_{CC}	Low side and logic fixed supply voltage	-0.3	25	
V_{LO}	Low side output voltage	-0.3	$V_{CC} + 0.3$	
V_{IN}	Logic input voltage	-0.3	$V_{CC} + 0.3$	
dV_S/dt	Allowable offset supply voltage transient	—	50	V/ns
P_D	Package power dissipation @ $T_A \leq +25^\circ\text{C}$	—	0.625	W
R_{thJA}	Thermal resistance, junction to ambient	—	200	$^\circ\text{C/W}$
T_J	Junction temperature	—	150	$^\circ\text{C}$
T_S	Storage temperature	-55	150	
T_L	Lead temperature (soldering, 10 seconds)	—	300	

Recommended Operating Conditions

For proper operation the device should be used within the recommended conditions. The V_S offset rating is tested with all supplies biased at 15V differential.

Symbol	Definition	Min.	Max.	Units
V_B	High side floating supply absolute voltage	$V_S + 10$	$V_S + 20$	V
V_S	High side floating supply offset voltage	†	600	
V_{HO}	High side floating output voltage	V_S	V_B	
V_{CC}	Low side and logic fixed supply voltage	10	20	
V_{LO}	Low side output voltage	0	V_{CC}	
V_{IN}	Logic input voltage	0	V_{CC}	
T_A	Ambient temperature	-40	125	$^\circ\text{C}$

† Logic operational for V_S of -5 to +600V. Logic state held for V_S of -5V to -VBS. (Please refer to Design Tip DT97-3 for more details).

Dynamic Electrical Characteristics

V_{BIAS} (V_{CC} , V_{BS}) = 15V, C_L = 1000 pF and T_A = 25°C unless otherwise specified.

Symbol	Definition	Min.	Typ.	Max.	Units	Test Conditions
t_{on}	Turn-on propagation delay	—	220	300	ns	$V_S = 0V$
t_{off}	Turn-off propagation delay	—	200	280		$V_S = 0V$ or 600V
t_r	Turn-on rise time	—	150	220		$V_S = 0V$
t_f	Turn-off fall time	—	50	80		$V_S = 0V$
MT	Delay matching, HS & LS turn-on/off	—	0	30		

Static Electrical Characteristics

V_{BIAS} (V_{CC} , V_{BS}) = 15V and T_A = 25°C unless otherwise specified. The V_{IN} , V_{TH} and I_{IN} parameters are referenced to COM. The V_O and I_O parameters are referenced to COM and are applicable to the respective output leads: HO and LO.

Symbol	Definition	Min.	Typ.	Max.	Units	Test Conditions
V_{IH}	Logic "1" input voltage	2.9	—	—	V	$V_{CC} = 10V$ to 20V
V_{IL}	Logic "0" input voltage	—	—	0.8		$V_{CC} = 10V$ to 20V
V_{OH}	High level output voltage, $V_{BIAS} - V_O$	—	0.8	1.4		$I_O = 20$ mA
V_{OL}	Low level output voltage, V_O	—	0.3	0.6		$I_O = 20$ mA
I_{LK}	Offset supply leakage current	—	—	50	μA	$V_B = V_S = 600V$
I_{QBS}	Quiescent V_{BS} supply current	20	75	130		$V_{IN} = 0V$ or 5V
I_{QCC}	Quiescent V_{CC} supply current	60	120	180		$V_{IN} = 0V$ or 5V
I_{IN+}	Logic "1" input bias current	—	5	20		$V_{IN} = 5V$
I_{IN-}	Logic "0" input bias current	—	—	2		$V_{IN} = 0V$
V_{CCUV+} V_{BSUV+}	V_{CC} and V_{BS} supply undervoltage positive going threshold	8	8.9	9.8	V	
V_{CCUV-} V_{BSUV-}	V_{CC} and V_{BS} supply undervoltage negative going threshold	7.4	8.2	9		
V_{CCUVH} V_{BSUVH}	Hysteresis	0.3	0.7	---		
I_{O+}	Output high short circuit pulsed current	120	200	—	mA	$V_O = 0V$ $PW \leq 10 \mu s$
I_{O-}	Output low short circuit pulsed current	250	350	—		$V_O = 15V$ $PW \leq 10 \mu s$

Functional Block Diagram

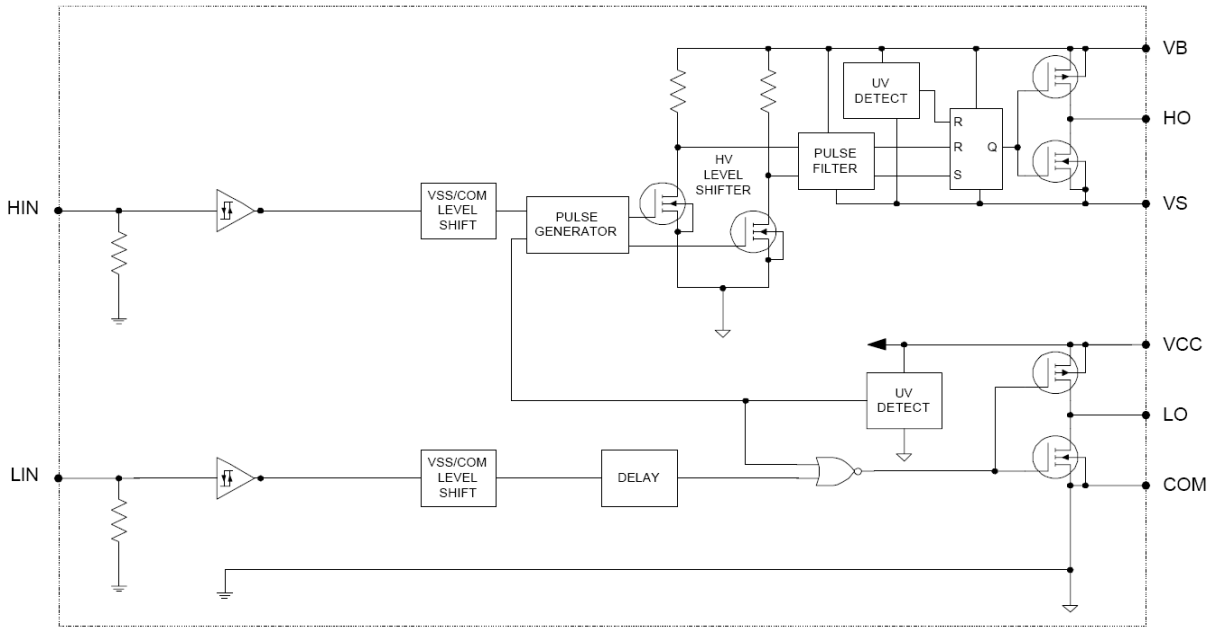

Lead Definitions

Symbol	Description
HIN	Logic input for high side gate driver outputs (HO), in phase
LIN	Logic input for high side gate driver outputs (LO), in phase
V _B	High side floating supply
HO	High side gate drive output
V _S	High side floating supply return
V _{CC}	Low side and logic fixed supply
LO	Low side gate drive output
COM	Low side return

Lead Assignments

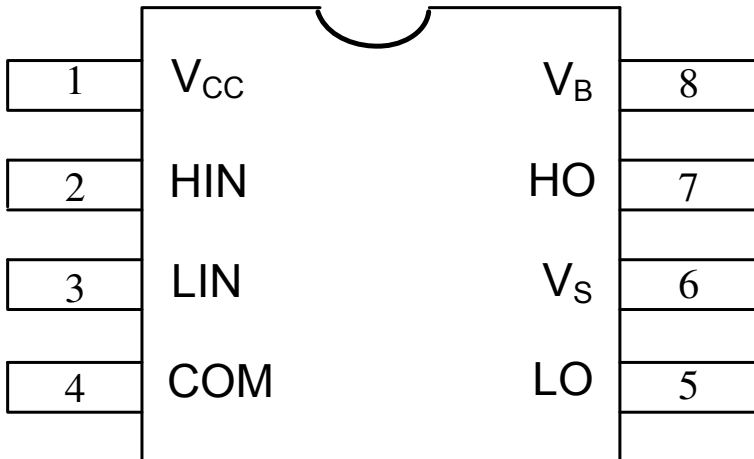

Application Information and Additional Details

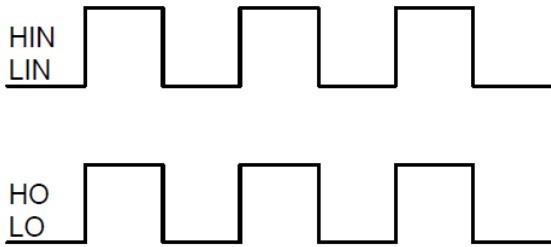

Figure 1. Input/Output Timing Diagram

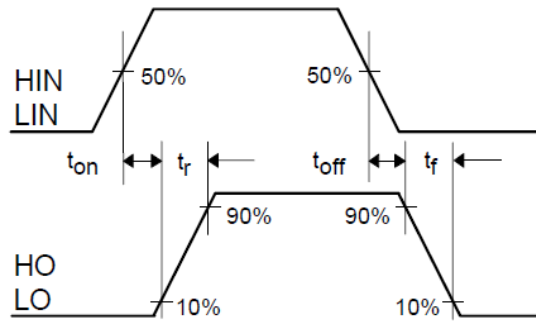

Figure 2. Switching Time Waveform Definitions

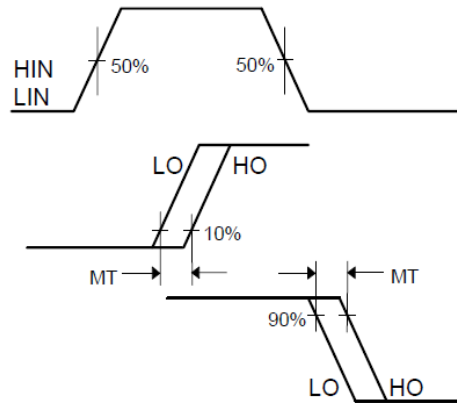

Figure 3. Delay Matching Waveform Definitions

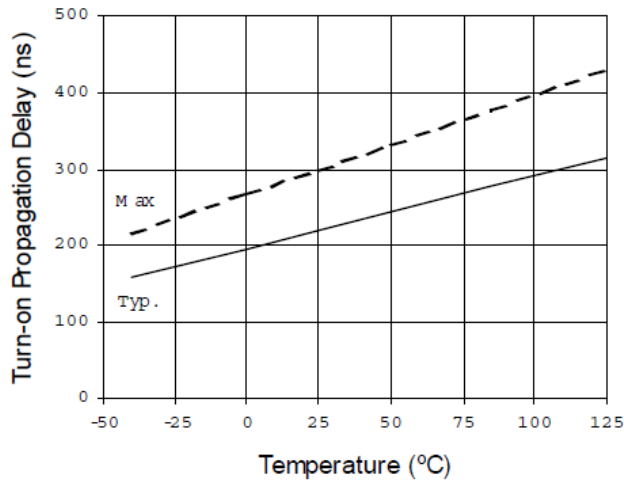

Figure 4A. Turn-on Propagation Delay vs. Temperature

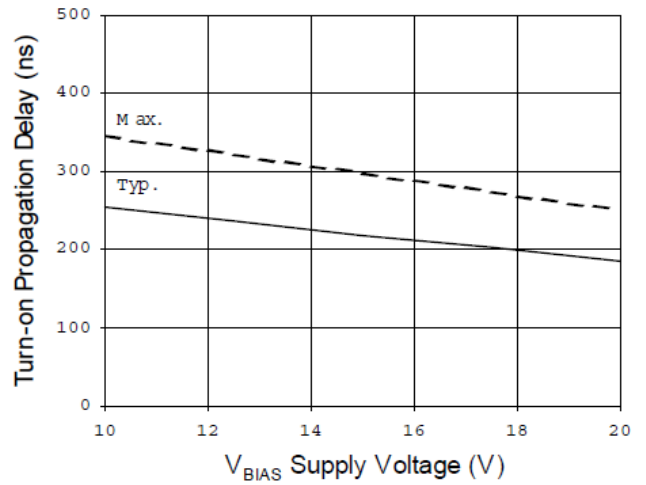

Figure 4B. Turn-on Propagation Delay vs. Supply Voltage

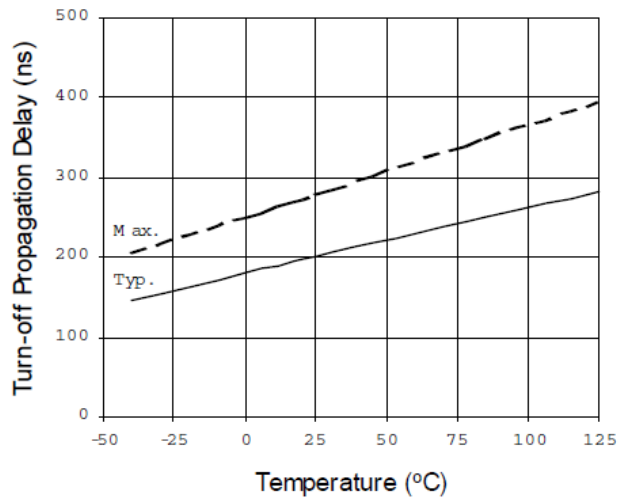

Figure 5A. Turn-off Propagation Delay vs. Temperature

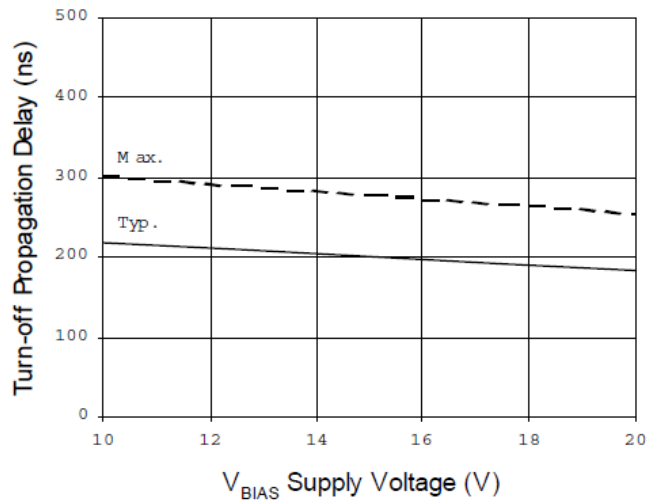

Figure 5B. Turn-off Propagation Delay vs. Supply Voltage

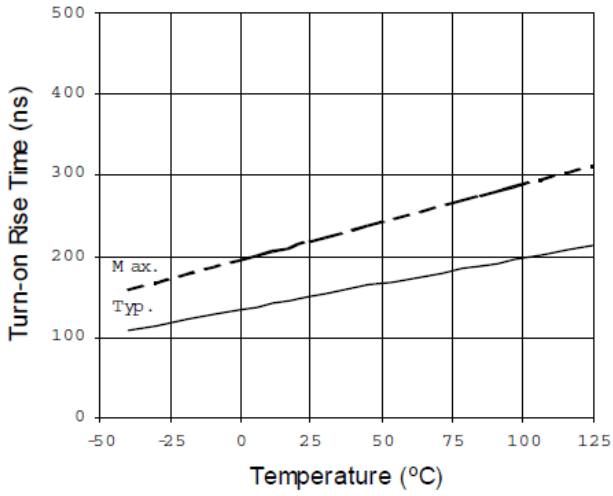

Figure 6A. Turn-on Rise Time vs. Temperature

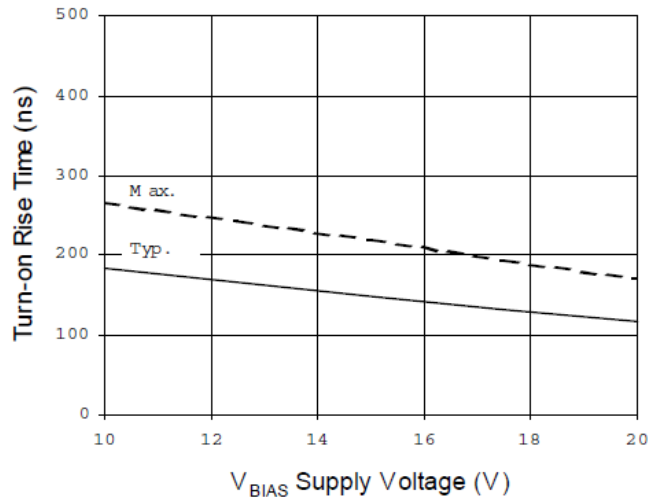

Figure 6B. Turn-on Rise Time vs. Supply Voltage

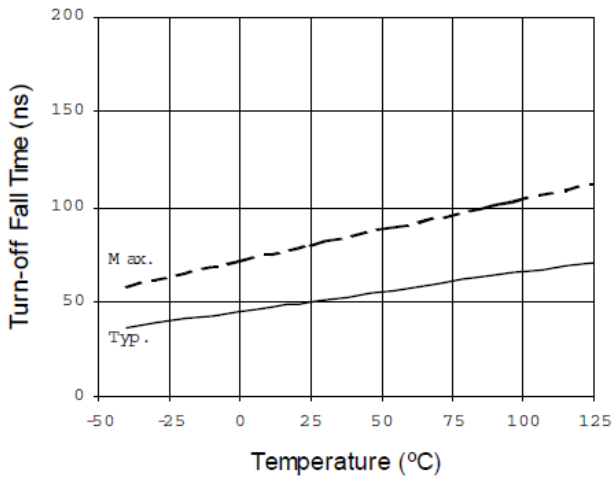

Figure 7A. Turn-off Fall Time vs. Temperature

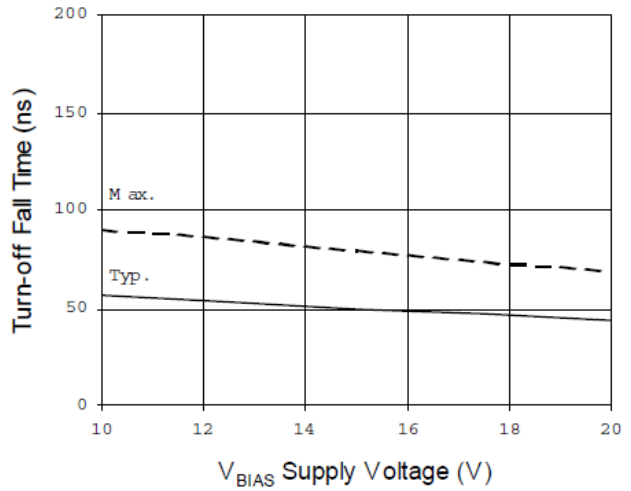

Figure 7B. Turn-off Fall Time vs. Supply Voltage

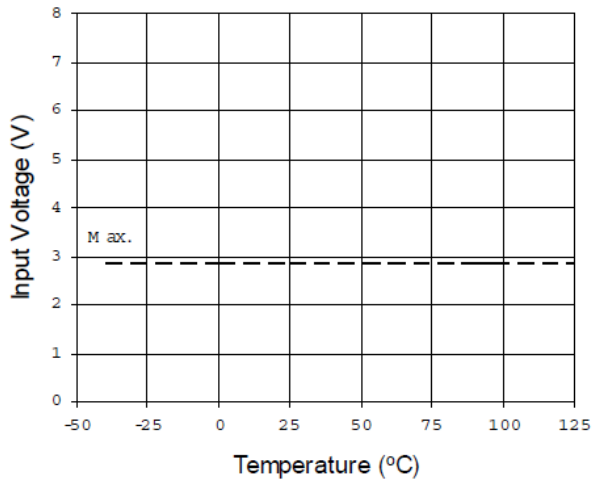

Figure 8A. Logic "1" Input Voltage vs. Temperature

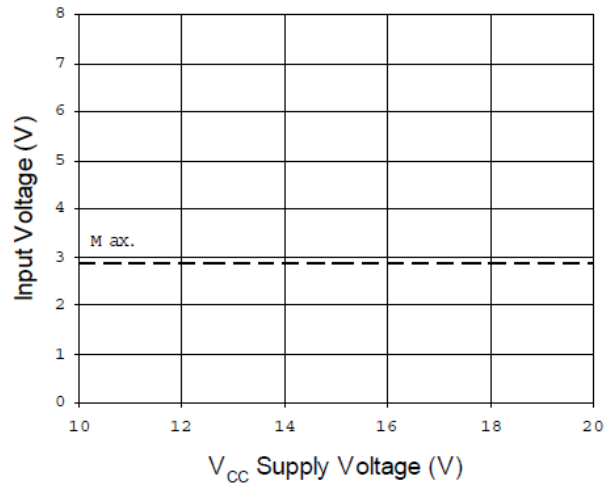

Figure 8B. Logic "1" Input Voltage vs. Supply Voltage

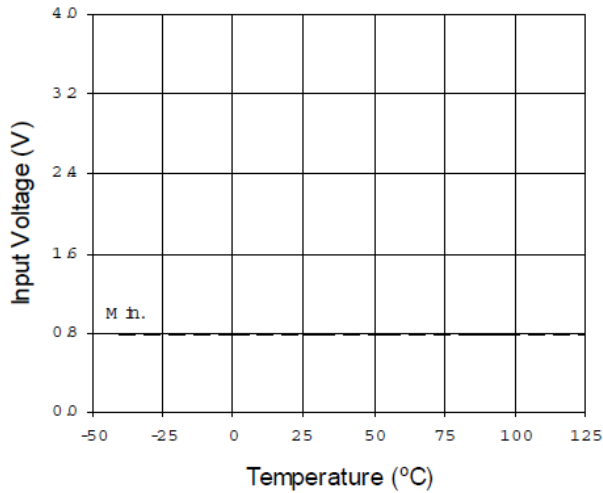

Figure 9A. Logic "0" Input Voltage vs. Temperature

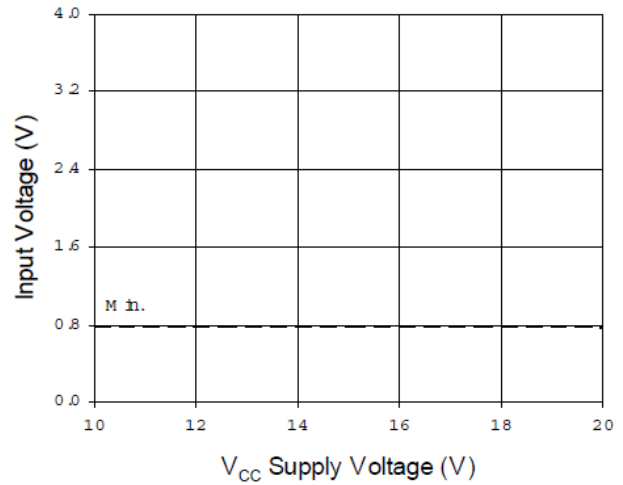

Figure 9B. Logic "0" Input Voltage vs. Supply Voltage

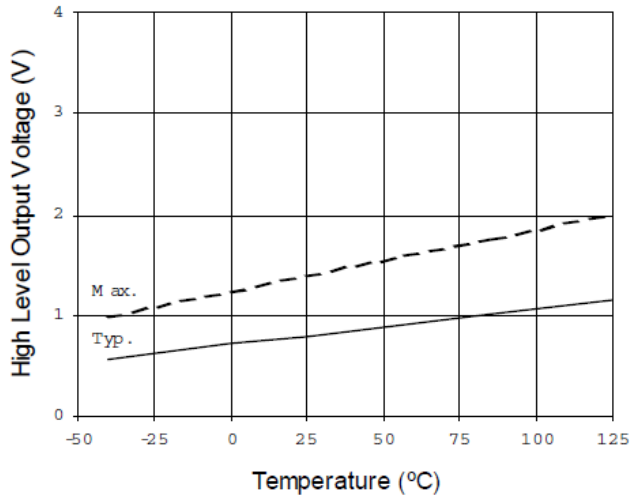

Figure 10A. High Level Output Voltage vs. Temperature

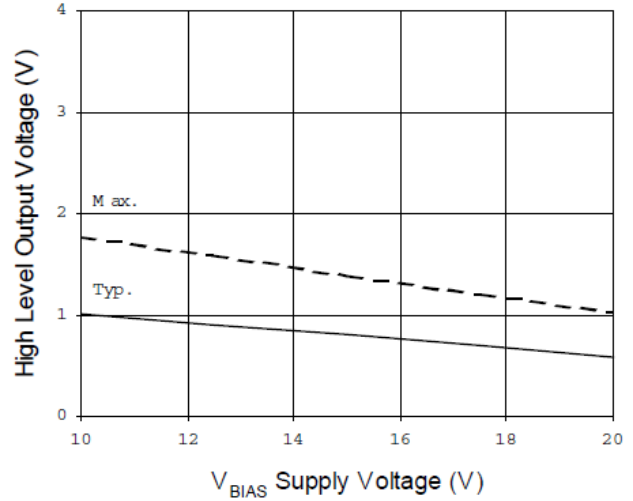

Figure 10B. High Level Output Voltage vs. Supply Voltage

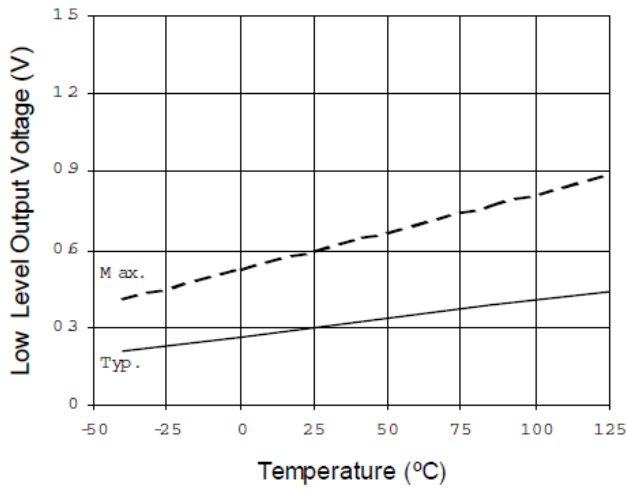

Figure 11A. Low Level Output Voltage vs. Temperature

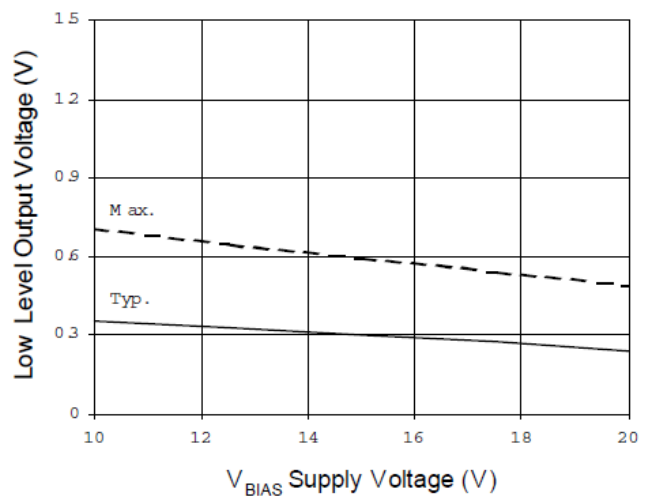

Figure 11B. Low Level Output Voltage vs. Supply Voltage

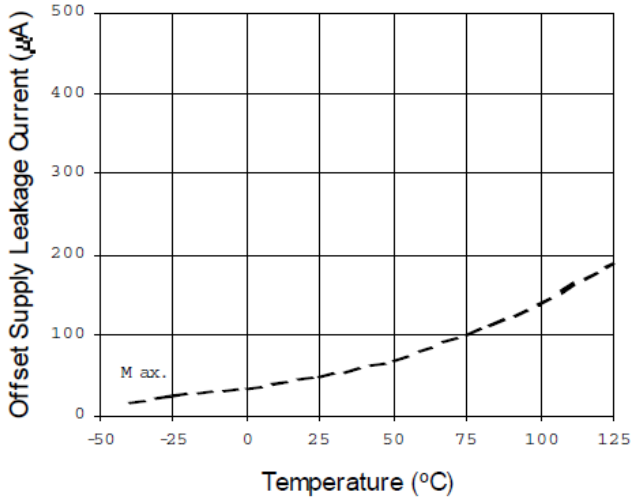

Figure 12A. Offset Supply Leakage Current vs. Temperature

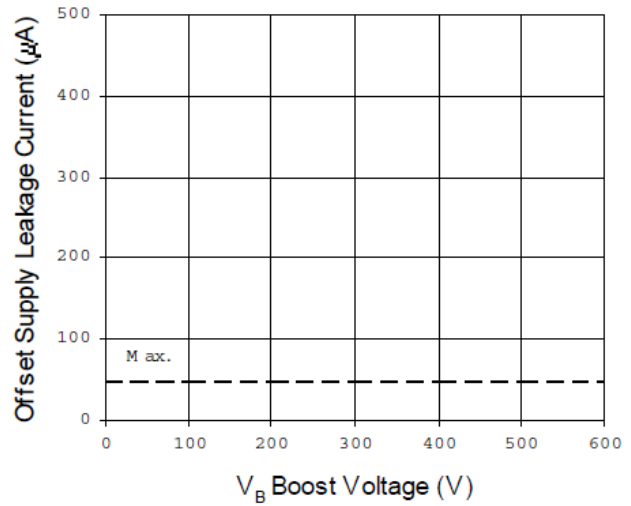

Figure 12B. Offset Supply Leakage Current vs. Supply Voltage

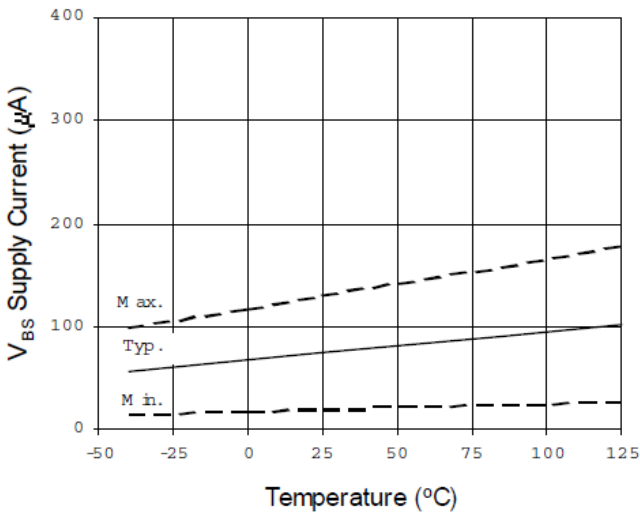

Figure 13A. V_{BS} Supply Current vs. Temperature

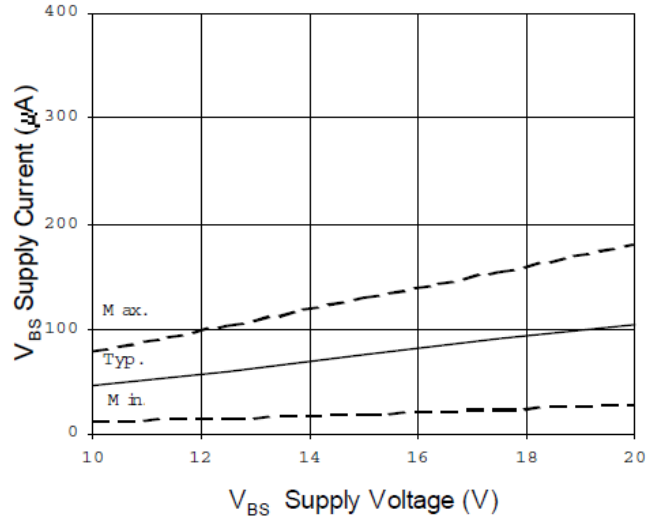

Figure 13B. V_{BS} Supply Current vs. Supply Voltage

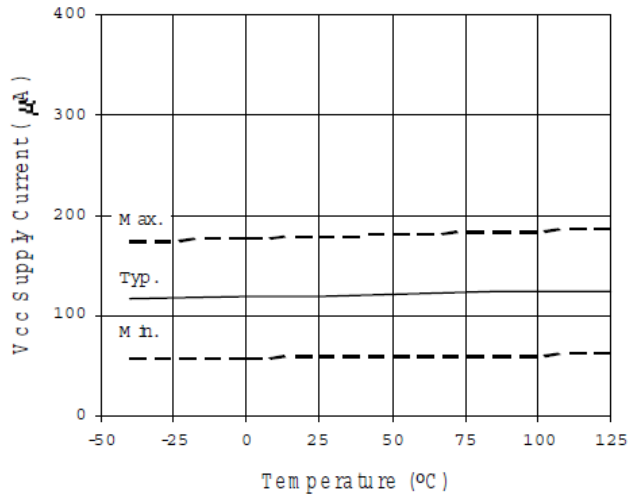

Figure 14A. Quiescent V_{CC} Supply Current vs. Temperature

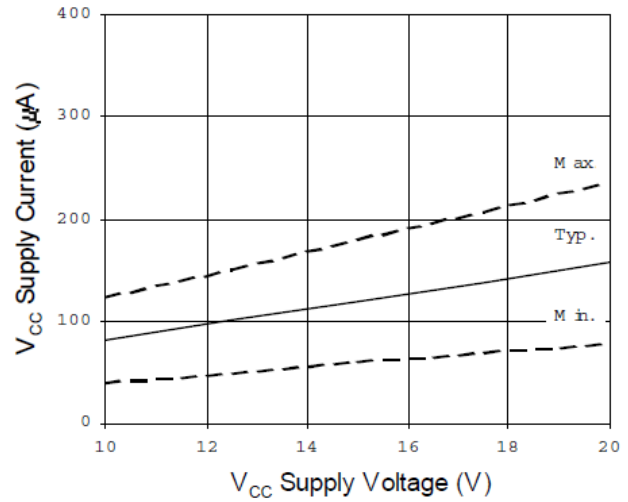

Figure 14B. Quiescent V_{CC} Supply Current vs. V_{CC} Supply Voltage

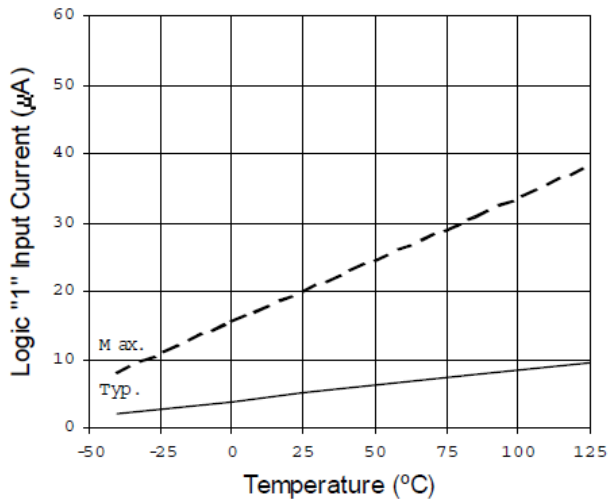

Figure 15A. Logic "1" Input Current vs. Temperature

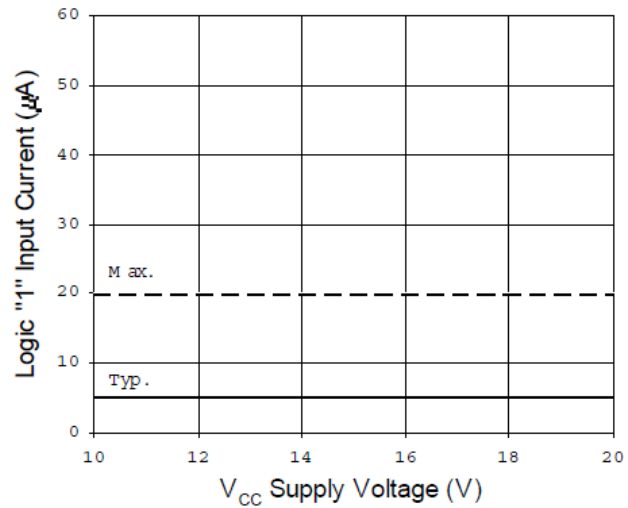

Figure 15B. Logic "1" Bias Current vs. Supply Voltage

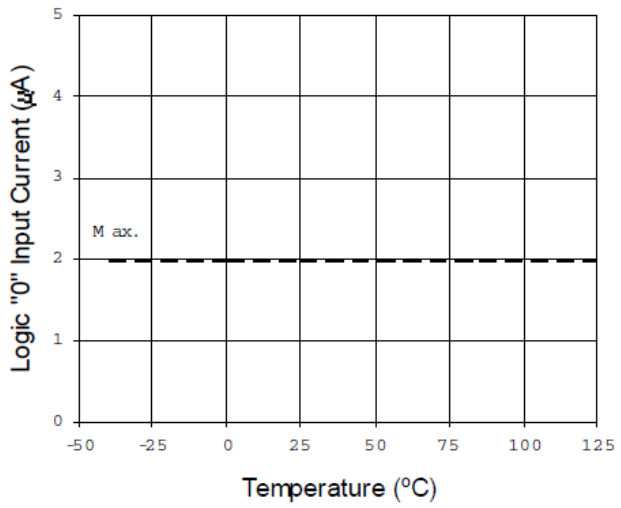

Figure 16A. Logic "0" Input Current vs. Temperature

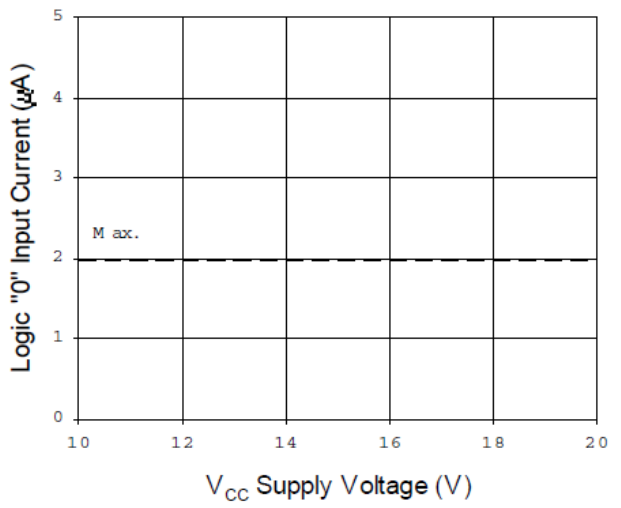

Figure 16B. Logic "0" Input Current vs. Supply Voltage

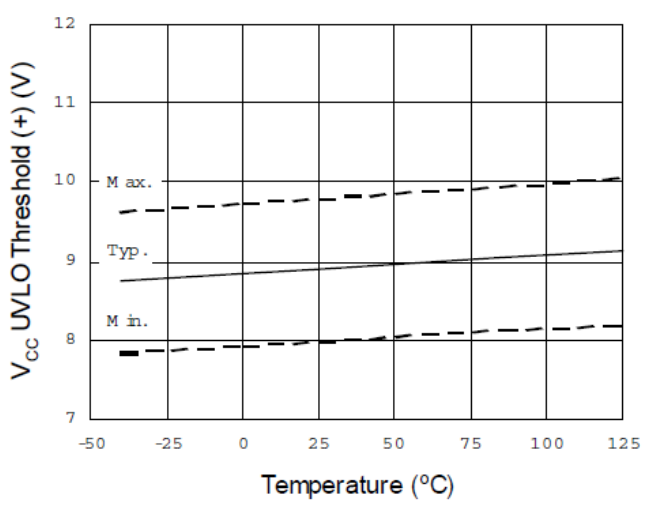

Figure 17. V_{CC} Undervoltage Threshold (+) vs. Temperature

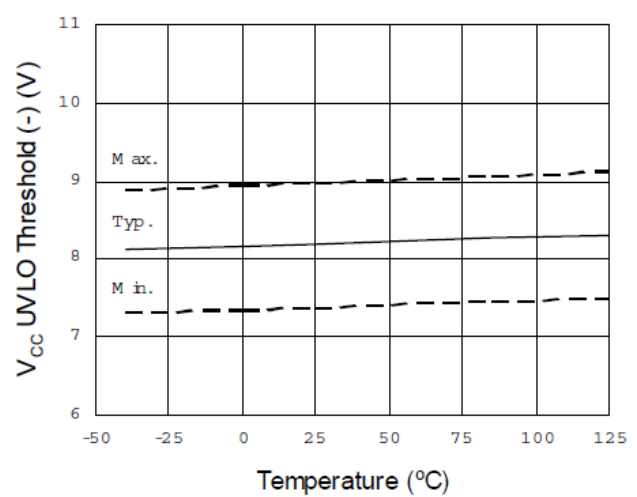

Figure 18. V_{CC} Undervoltage Threshold (-) vs. Temperature

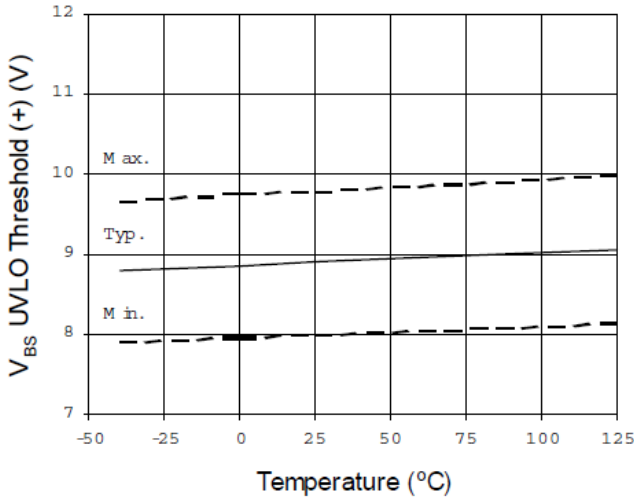

Figure 19. V_{BS} Undervoltage Threshold (+) vs. Temperature

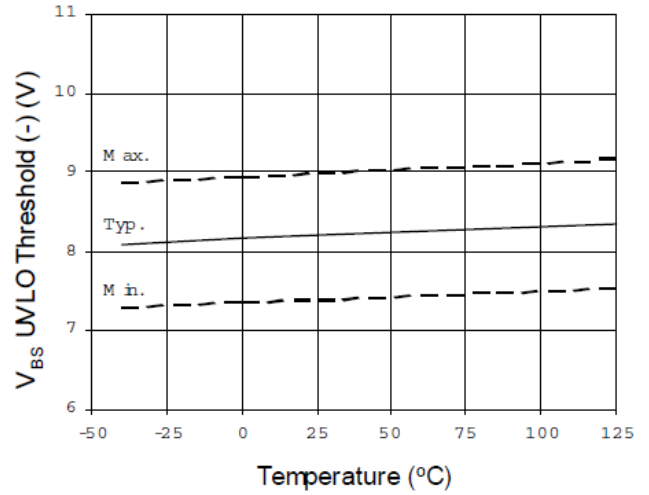

Figure 20. V_{BS} Undervoltage Threshold (-) vs. Temperature

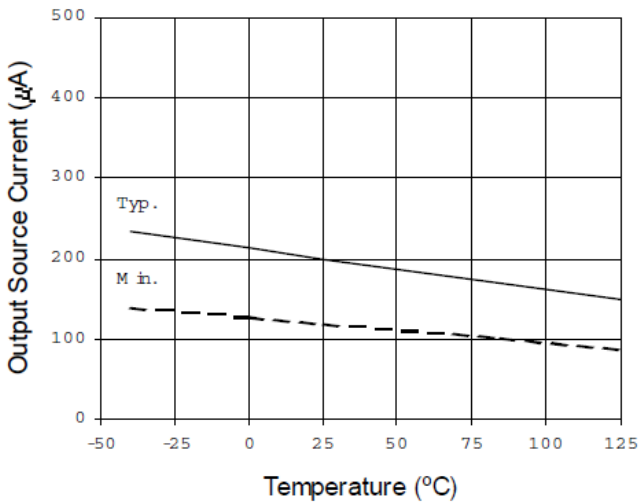

Figure 21A. Output Source Current vs. Temperature

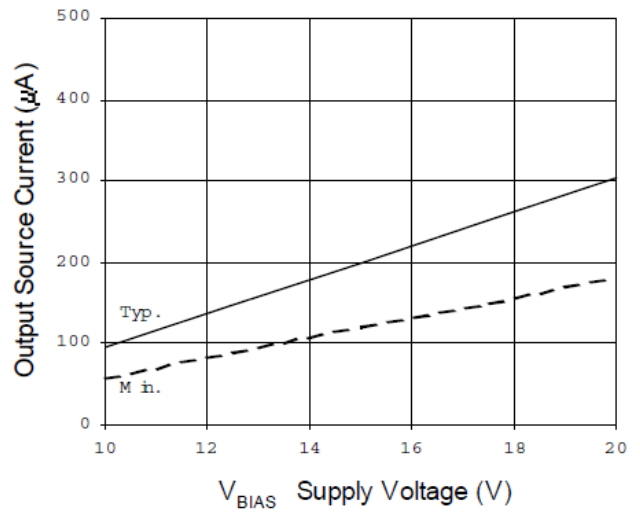

Figure 21B. Output Source Current vs. Supply Voltage

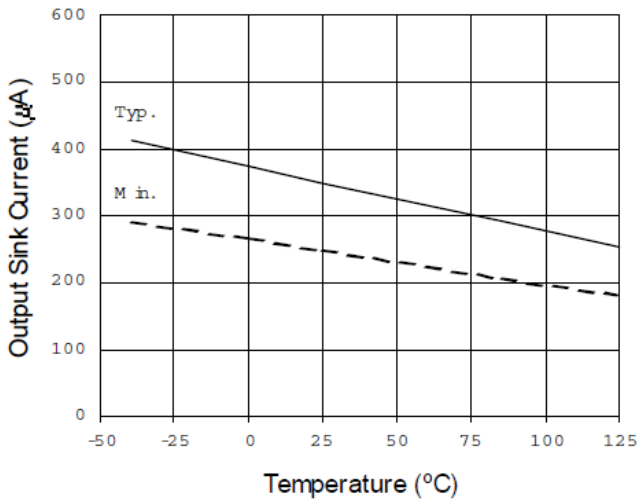

Figure 22A. Output Sink Current vs. Temperature

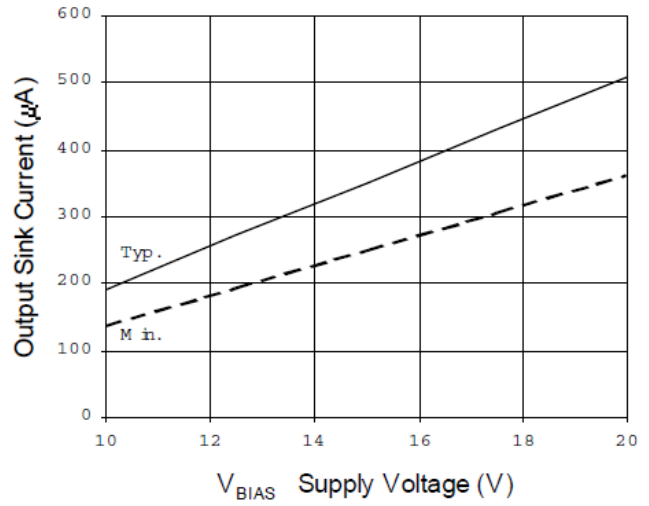

Figure 22B. Output Sink Current vs. Supply Voltage

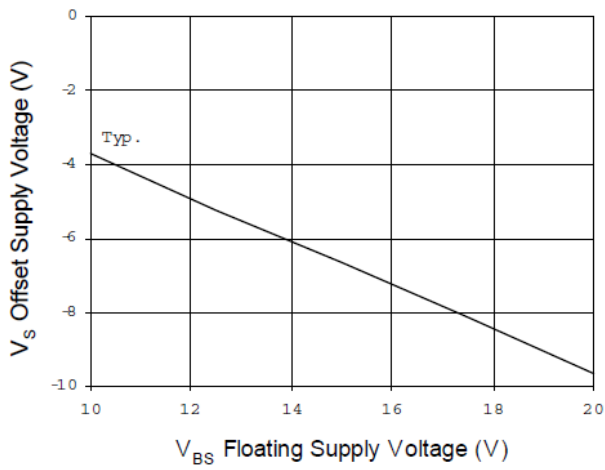
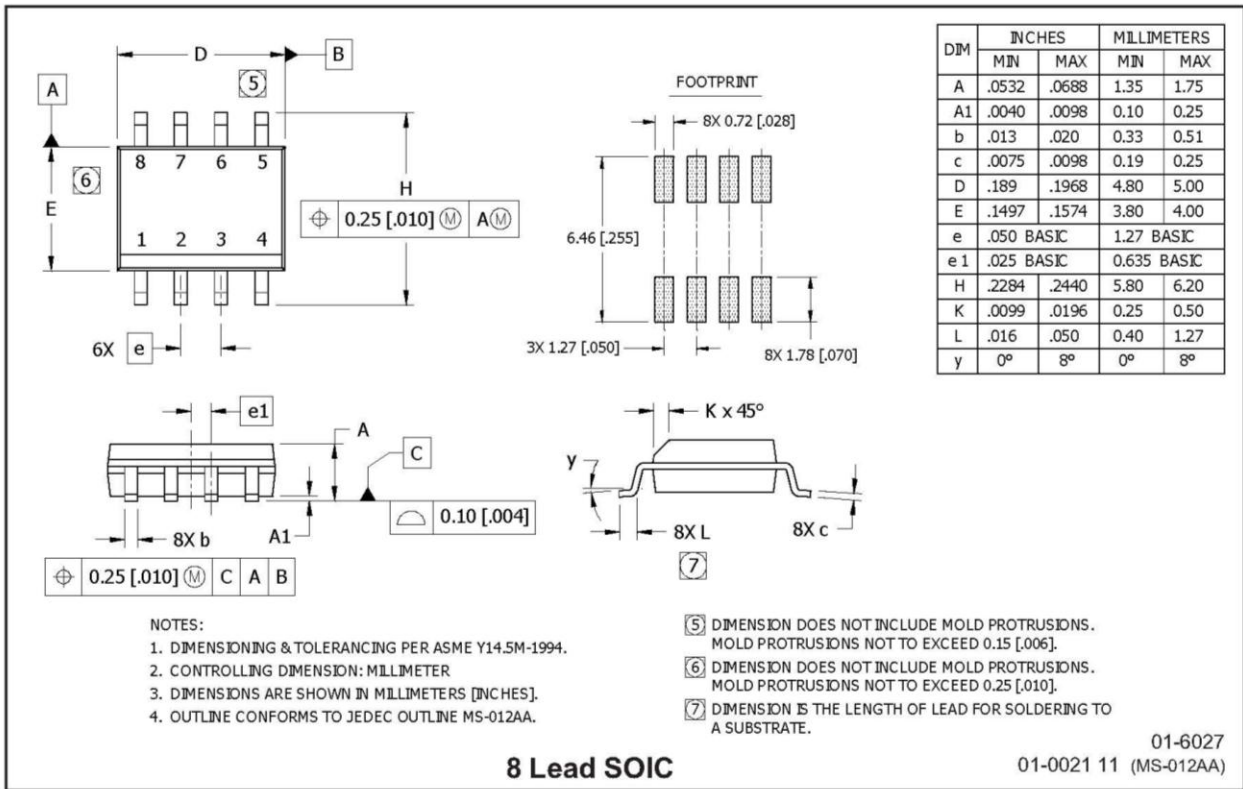

Figure 23. Maximum V_S Negative Offset vs. Supply Voltage

Package Details

- NOTES:
1. DIMENSIONING & TOLERANCING PER ASME Y14.5M-1994.
 2. CONTROLLING DIMENSION: MILLIMETER
 3. DIMENSIONS ARE SHOWN IN MILLIMETERS [INCHES].
 4. OUTLINE CONFORMS TO JEDEC OUTLINE MS-012AA.

- 5 DIMENSION DOES NOT INCLUDE MOLD PROTRUSIONS. MOLD PROTRUSIONS NOT TO EXCEED 0.15 [0.06].
- 6 DIMENSION DOES NOT INCLUDE MOLD PROTRUSIONS. MOLD PROTRUSIONS NOT TO EXCEED 0.25 [0.10].
- 7 DIMENSION IS THE LENGTH OF LEAD FOR SOLDERING TO A SUBSTRATE.

Tape and Reel Details

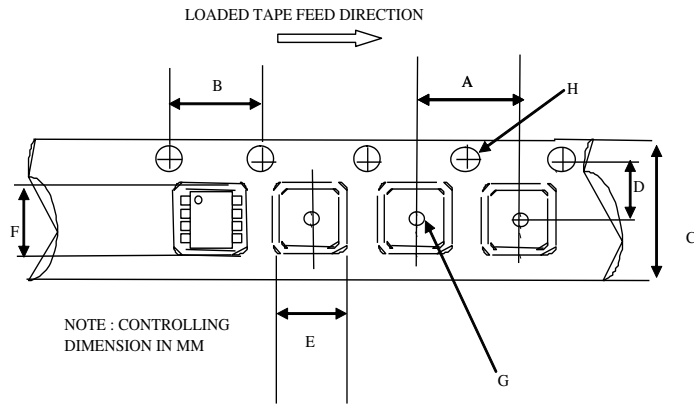

CARRIER TAPE DIMENSION FOR 8SOICN

Code	Metric		Imperial	
	Min	Max	Min	Max
A	7.90	8.10	0.311	0.318
B	3.90	4.10	0.153	0.161
C	11.70	12.30	0.46	0.484
D	5.45	5.55	0.214	0.218
E	6.30	6.50	0.248	0.255
F	5.10	5.30	0.200	0.208
G	1.50	n/a	0.059	n/a
H	1.50	1.60	0.059	0.062

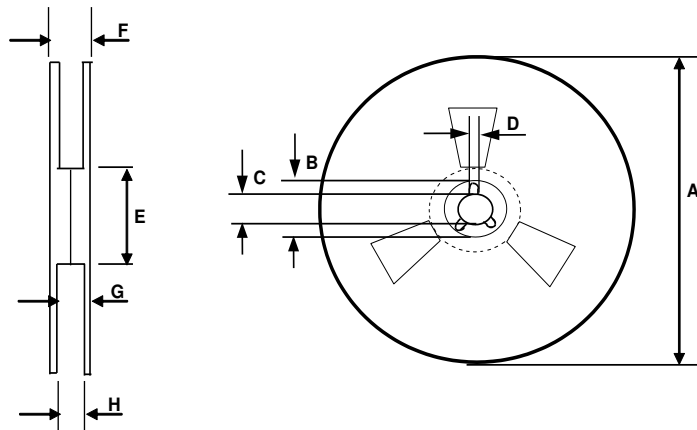

REEL DIMENSIONS FOR 8SOICN

Code	Metric		Imperial	
	Min	Max	Min	Max
A	329.60	330.25	12.976	13.001
B	20.95	21.45	0.824	0.844
C	12.80	13.20	0.503	0.519
D	1.95	2.45	0.767	0.096
E	98.00	102.00	3.858	4.015
F	n/a	18.40	n/a	0.724
G	14.50	17.10	0.570	0.673
H	12.40	14.40	0.488	0.566

Part Marking Information

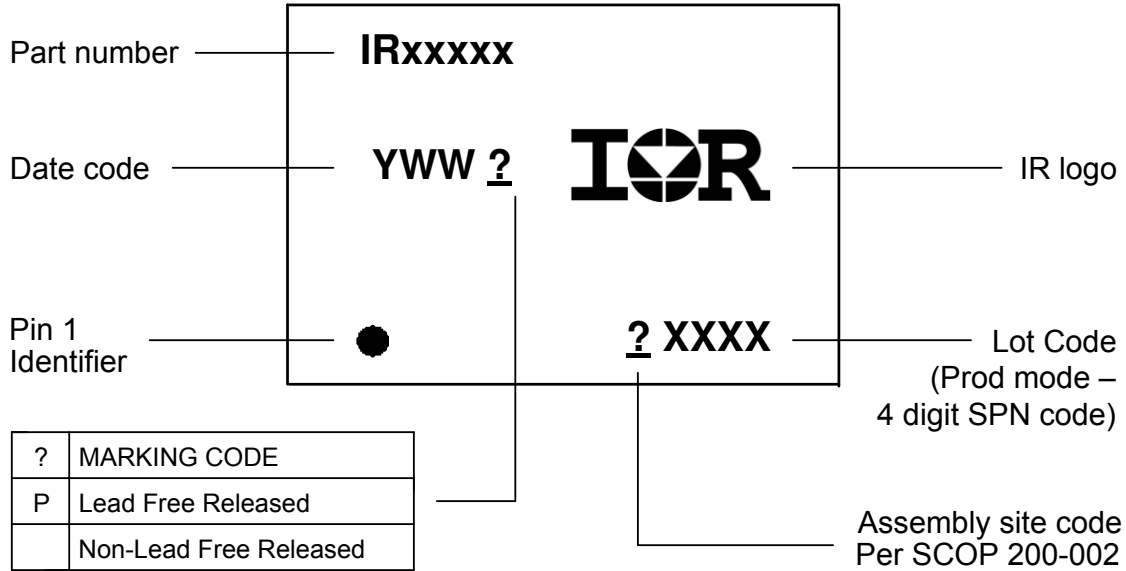

Qualification Information[†]

Qualification Level	Industrial ^{††} (per JEDEC JESD 47)
	Comments: This family of ICs has passed JEDEC's Industrial qualification. IR's Consumer qualification level is granted by extension of the higher Industrial level.
Moisture Sensitivity Level	MSL2 ^{†††} (per IPC/JEDEC J-STD-020)
RoHS Compliant	Yes

- † Qualification standards can be found at International Rectifier's web site <http://www.irf.com/>
- †† Higher qualification ratings may be available should the user have such requirements. Please contact your International Rectifier sales representative for further information.
- ††† Higher MSL ratings may be available for the specific package types listed here. Please contact your International Rectifier sales representative for further information.

The information provided in this document is believed to be accurate and reliable. However, International Rectifier assumes no responsibility for the consequences of the use of this information. International Rectifier assumes no responsibility for any infringement of patents or of other rights of third parties which may result from the use of this information. No license is granted by implication or otherwise under any patent or patent rights of International Rectifier. The specifications mentioned in this document are subject to change without notice. This document supersedes and replaces all information previously supplied.

For technical support, please contact IR's Technical Assistance Center
<http://www.irf.com/technical-info/>

WORLD HEADQUARTERS:
 233 Kansas St., El Segundo, California 90245
 Tel: (310) 252-7105