



N-Channel JFETs

PRODUCT SUMMARY				
Part Number	V _{GS(off)} (V)	r _{DS(on)} Max (Ω)	I _{D(off)} Typ (pA)	t _{ON} Typ (ns)
2N5432	-4 to -10	5	10	2.5
2N5433	-3 to -9	7	10	2.5
2N5434	-1 to -4	10	10	2.5

FEATURES

- Low On-Resistance: 2N5432 <5 Ω
- Fast Switching—t_{ON}: 2.5 ns
- High Off-Isolation—I_{D(off)}: 10 pA
- Low Capacitance: 11 pF
- Low Insertion Loss

BENEFITS

- Low Error Voltage
- High-Speed Analog Circuit Performance
- Negligible “Off-Error,” Excellent Accuracy
- Good Frequency Response
- Eliminates Additional Buffering

APPLICATIONS

- Analog Switches
- Choppers
- Sample-and-Hold
- Normally “On” Switches
- Current Limiters

DESCRIPTION

The 2N5432/5433/5434 are suitable for high-performance analog switching and amplifier applications. Breakdown voltage characteristics, low on-resistance, and very fast switching make these devices ideal for a wide range of applications.

The hermetically-sealed TO-206AC (TO-52) package is suitable for processing per MIL-S-19500 (see Military Information). For similar products in TO-236 (SOT-23) or TO-226AA (TO-92) packages, see the J/SST108 series data sheet.

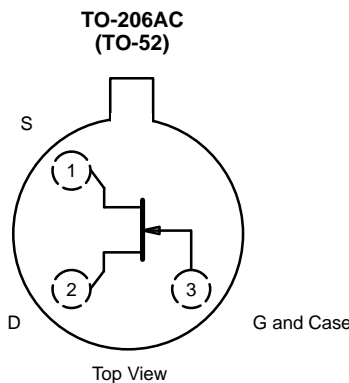

ABSOLUTE MAXIMUM RATINGS

Gate-Drain, Gate-Source Voltage -25 V
 Gate Current 100 mA
 Lead Temperature (1/16" from case for 10 sec.) 300°C
 Storage Temperature -65 to 200°C

Operating Junction Temperature -55 to 150°C
 Power Dissipation^a 300 mW

Notes
 a. Derate 2.4 mW/°C above 25°C



SPECIFICATIONS (T _A = 25 °C UNLESS OTHERWISE NOTED)										
Parameter	Symbol	Test Conditions	Typ ^a	Limits						Unit
				2N5432		2N5433		2N5434		
				Min	Max	Min	Max	Min	Max	
Static										
Gate-Source Breakdown Voltage	V _{(BR)GSS}	I _G = -1 μA, V _{DS} = 0 V	-32	-25		-25		-25		V
Gate-Source Cutoff Voltage	V _{GS(off)}	V _{DS} = 5 V, I _D = 3 nA		-4	-10	-3	-9	-1	-4	
Saturation Drain Current ^b	I _{DSS}	V _{DS} = 15 V, V _{GS} = 0 V		150		100		30		mA
Gate Reverse Current	I _{GSS}	V _{GS} = -15 V, V _{DS} = 0 V T _A = 150 °C	-5		-200		-200		-200	pA
			-10		-200		-200		-200	nA
Gate Operating Current ^c	I _G	V _{DG} = 10 V, I _D = 10 mA	-10							pA
Drain Cutoff Current	I _{D(off)}	V _{DS} = 5 V, V _{GS} = -10 V T _A = 150 °C	10		200		200		200	
			20		200		200		200	nA
Drain-Source On-Voltage	V _{DS(on)}	V _{GS} = 0 V, I _D = 10 mA			50		70		100	mV
Drain-Source On-Resistance	r _{DS(on)}			2	5		7		10	Ω
Gate-Source Forward Voltage ^c	V _{GS(F)}	I _G = 1 mA, V _{DS} = 0 V	0.7							V
Dynamic										
Common-Source Forward Transconductance ^c	g _{fs}	V _{DS} = 5 V, I _D = 10 mA f = 1 kHz	17							mS
			600							μS
Common-Source Output Conductance ^c	g _{os}									
Drain-Source On-Resistance	r _{ds(on)}	V _{GS} = 0 V, I _D = 0 mA f = 1 kHz			5		7		10	Ω
Common-Source Input Capacitance	C _{iss}	V _{DS} = 0 V, V _{GS} = -10 V f = 1 MHz	20		30		30		30	pF
Common-Source Reverse Transfer Capacitance	C _{rss}		11		15		15		15	
Equivalent Input Noise Voltage ^c	e _n	V _{DS} = 5 V, I _D = 10 mA f = 1 kHz	3.5							nV/ √Hz
Switching										
Turn-On Time ^b	t _{d(on)}	V _{DD} = 1.5 V, V _{GS(H)} = 0 V See Switching Circuit	2		4		4		4	ns
	t _r		0.5		1		1		1	
Turn-Off Time ^b	t _{d(off)}		4		6		6		6	
	t _f		18		30		30		30	

- Notes
- a. Typical values are for DESIGN AID ONLY, not guaranteed nor subject to production testing.
 - b. Pulse test: PW ≤ 300 μs duty cycle ≤ 3%.
 - c. This parameter not registered with JEDEC.

NIP



TYPICAL CHARACTERISTICS (T_A = 25 °C UNLESS OTHERWISE NOTED)

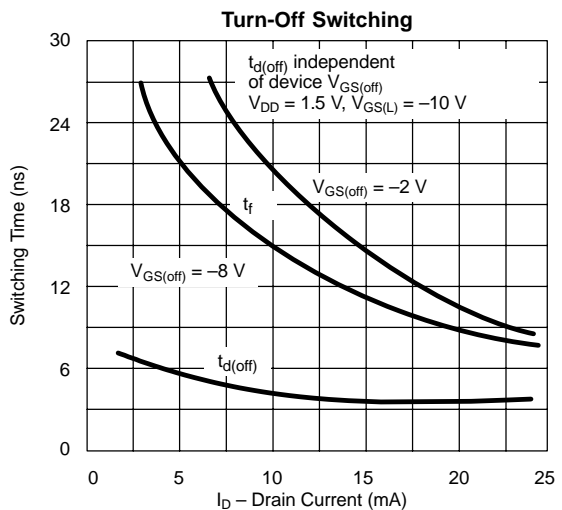
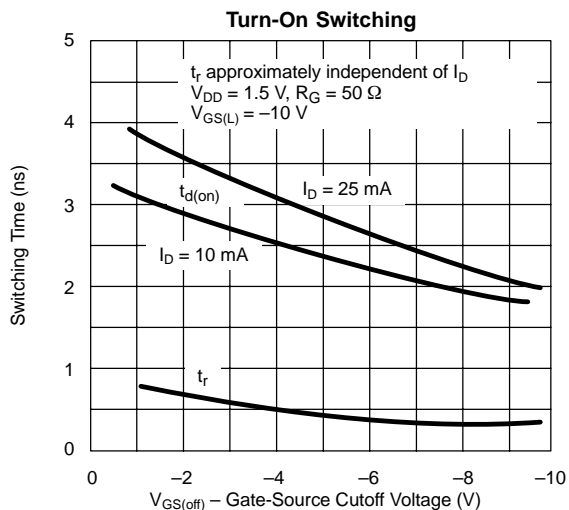
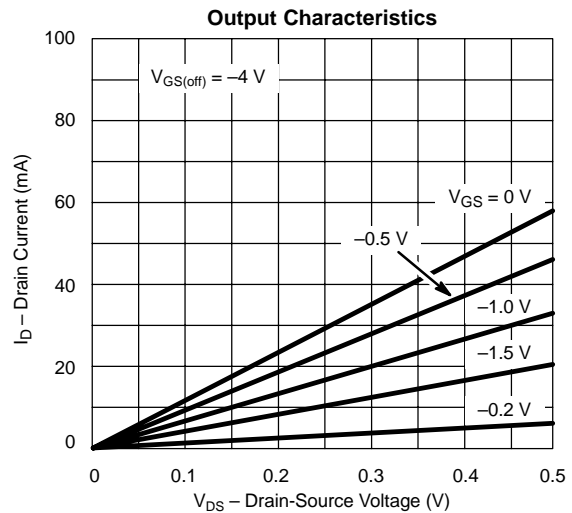
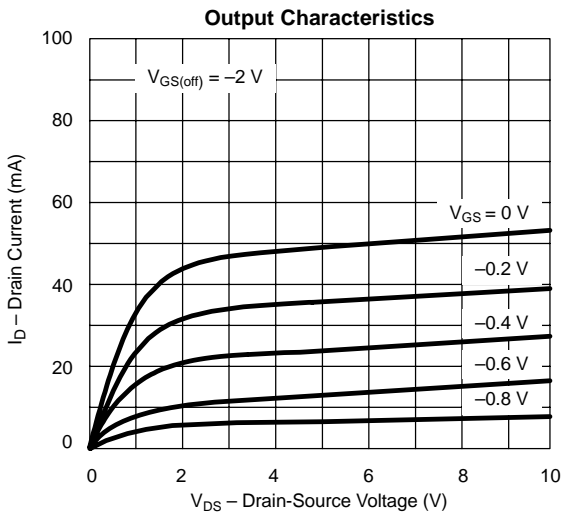
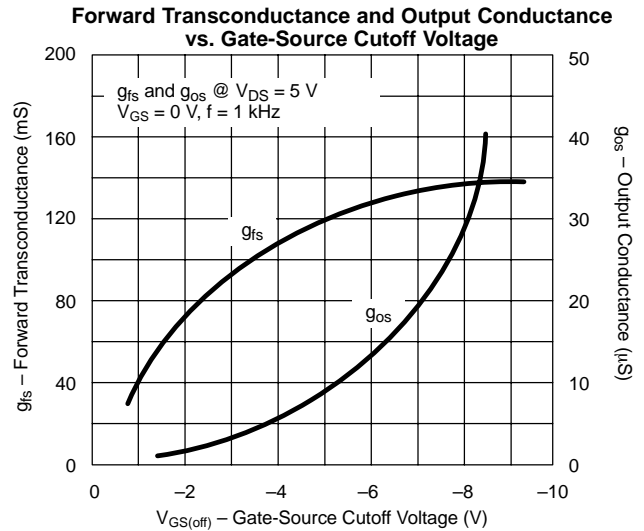
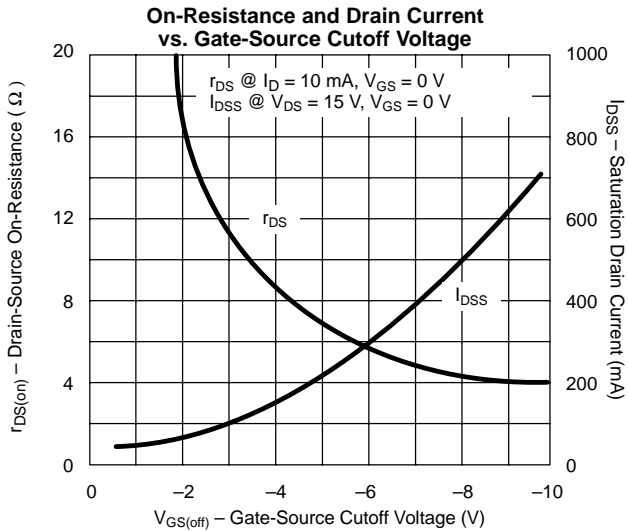

TYPICAL CHARACTERISTICS (25°C UNLESS NOTED)

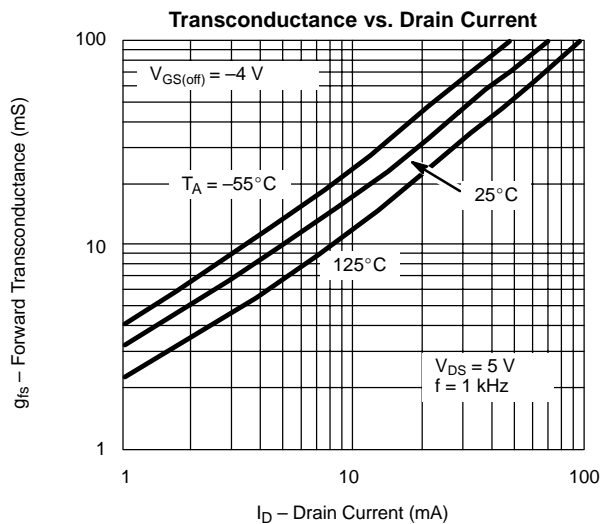
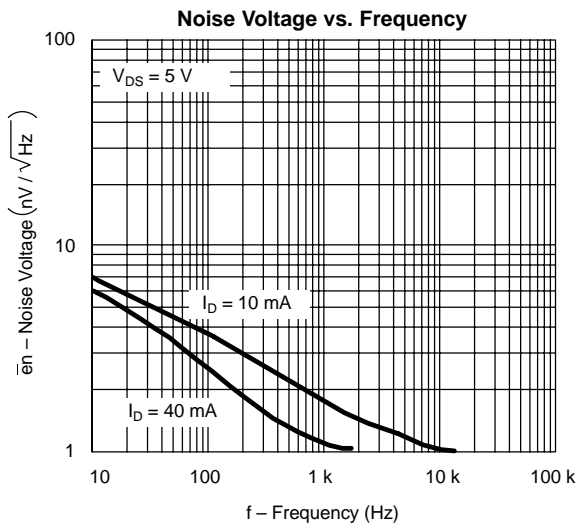
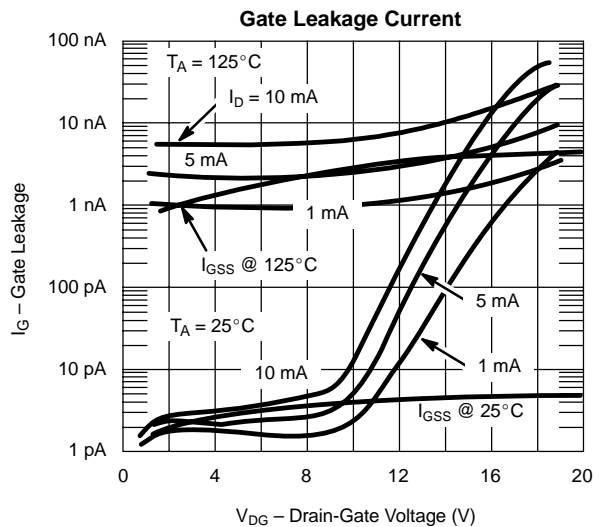
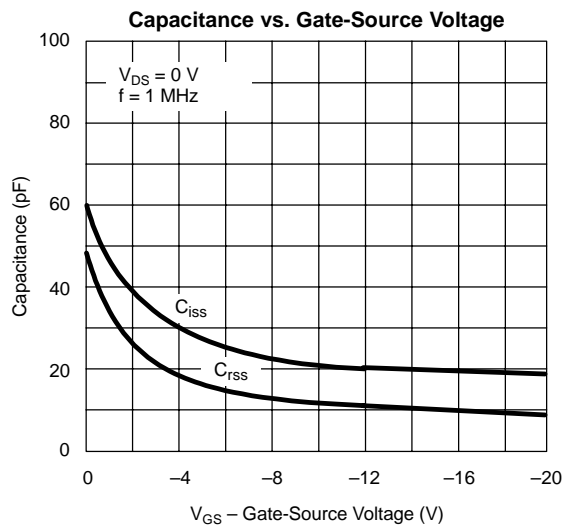
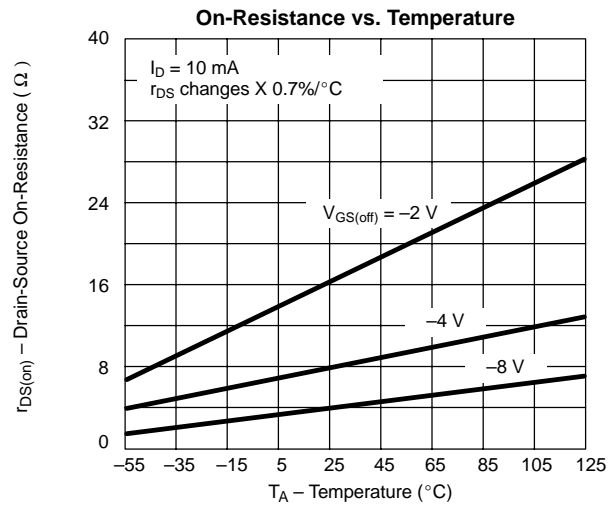
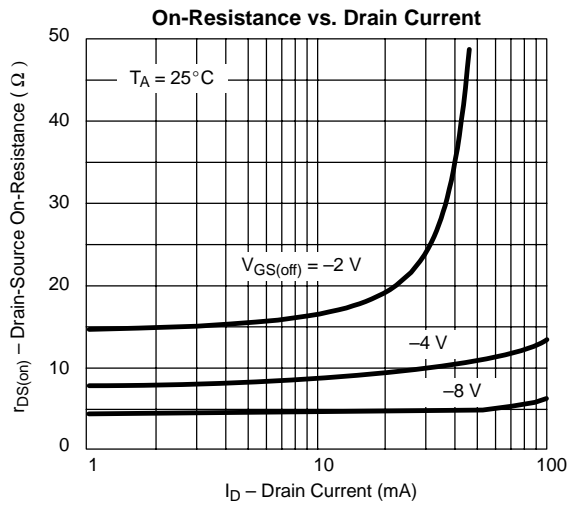



TYPICAL CHARACTERISTICS (25°C UNLESS NOTED)

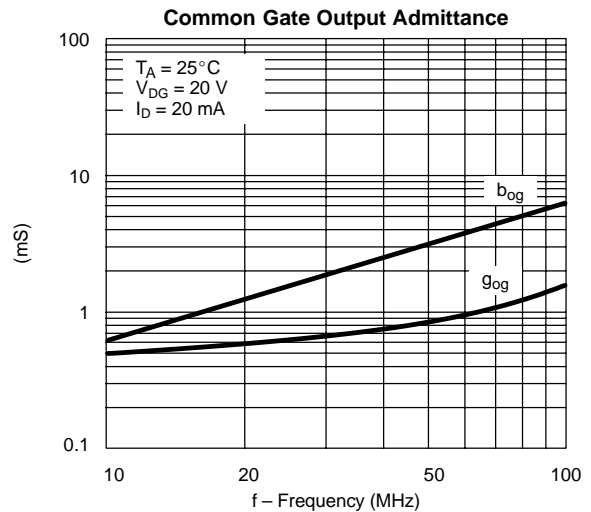
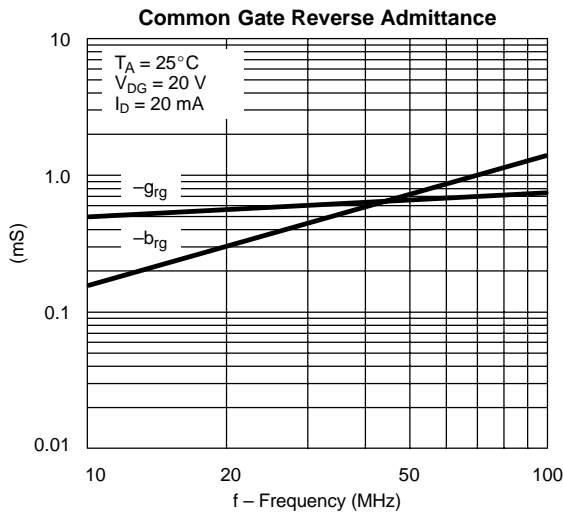
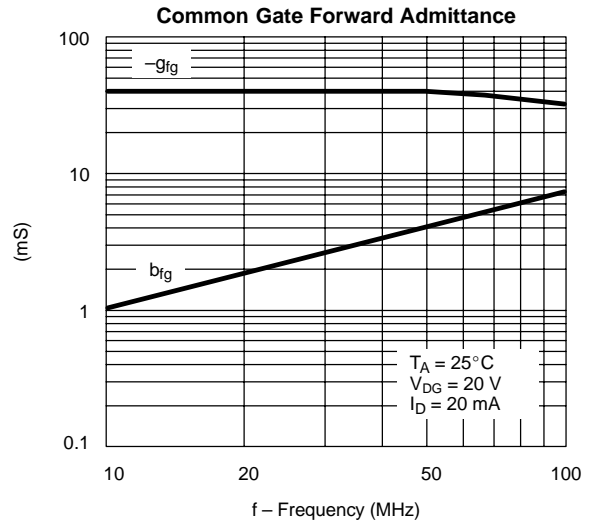
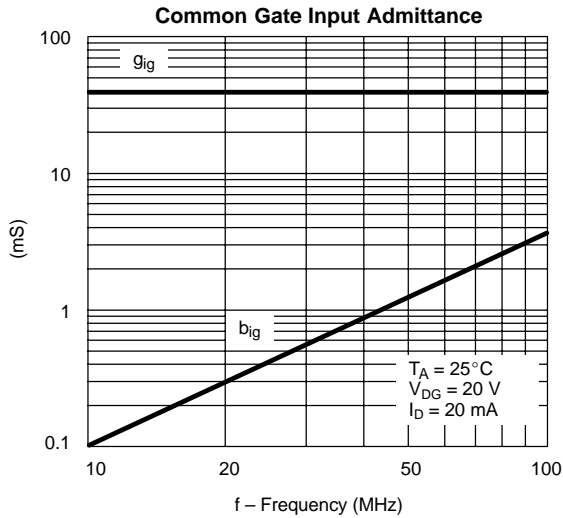

SWITCHING TIME TEST CIRCUIT			
	2N5432	2N5433	2N5434
$V_{GS(L)}$	-12 V	-12 V	-12 V
R_L^*	145 Ω	143 Ω	140 Ω
$I_{D(on)}$	10 mA	10 mA	10 mA

*Non-inductive

INPUT PULSE

Rise Time < 1 ns
 Fall Time < 1 ns
 Pulse Width 100 ns
 PRF 1 MHz

SAMPLING SCOPE

Rise Time 0.4 ns
 Input Resistance 10 M Ω
 Input Capacitance 1.5 pF

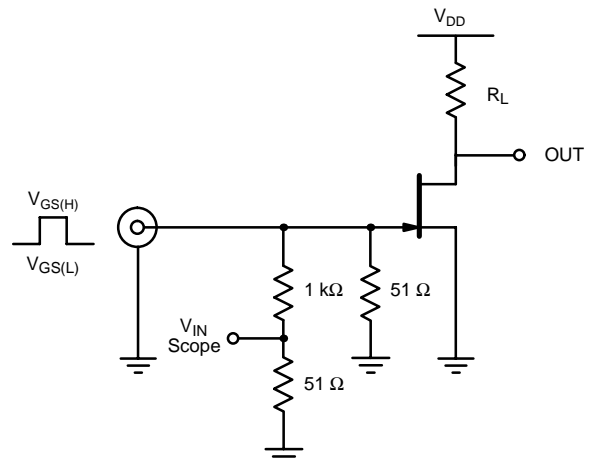



Disclaimer

All product specifications and data are subject to change without notice.

Vishay Intertechnology, Inc., its affiliates, agents, and employees, and all persons acting on its or their behalf (collectively, "Vishay"), disclaim any and all liability for any errors, inaccuracies or incompleteness contained herein or in any other disclosure relating to any product.

Vishay disclaims any and all liability arising out of the use or application of any product described herein or of any information provided herein to the maximum extent permitted by law. The product specifications do not expand or otherwise modify Vishay's terms and conditions of purchase, including but not limited to the warranty expressed therein, which apply to these products.

No license, express or implied, by estoppel or otherwise, to any intellectual property rights is granted by this document or by any conduct of Vishay.

The products shown herein are not designed for use in medical, life-saving, or life-sustaining applications unless otherwise expressly indicated. Customers using or selling Vishay products not expressly indicated for use in such applications do so entirely at their own risk and agree to fully indemnify Vishay for any damages arising or resulting from such use or sale. Please contact authorized Vishay personnel to obtain written terms and conditions regarding products designed for such applications.

Product names and markings noted herein may be trademarks of their respective owners.