

# 8000 series

Rugged switch fingertip controllers •  
switching technology



## DISTINCTIVE FEATURES

- One or two axis
- Single step or progressive switching
- Up to 1AMP operation
- Gold plated contacts
- Variety of handle options



## ENVIRONMENTAL SPECIFICATIONS

- Operating Temperature: -25 °C to +80 °C (-13 °F to +176 °F)
- Sealing: IP65 (above panel)



## ELECTRICAL SPECIFICATIONS

- Maximum Voltage: 30 VDC
- Output Impedance: <1 Ω



## MECHANICAL SPECIFICATIONS

- Maximum Load: to 1 A
- Angle of Movement: 36° X & Y axis (subject to configuration)
- Expected Mechanical Life: >1 million lifecycles
- Mass/weight: 98 g (3.46 oz)



## MATERIALS

- Shaft: Stainless steel
- Boot: Neoprene
- Handles :
  - BL, E, Q, AT, BB - Nylon
  - D, AK, AM - Aluminum
  - K, X, BK - ABS
  - AN - Delrin
- Contact : Gold plated silver
- Body : Glass Reinforced ABS
- Gimbal Pivot : Acetal & Hardened Steel

The company reserves the right to change specifications without notice.



# 8000 series

Rugged switch fingertip controllers • switching technology



## MOUNTING

### DROP-IN MOUNT CUT-OUT AND INSTALLATION

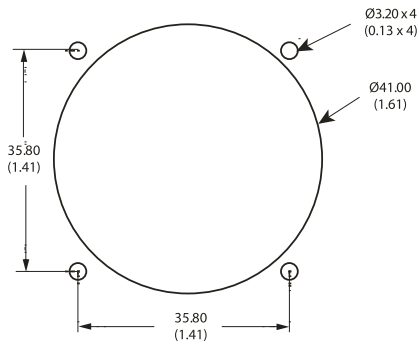

- The joystick is dropped into the panel cut-out. The joystick and boot must be kept in place by bezel (option 6 & 7).

- For panel thickness of <3 mm, m3 x 16 countersunk machine screws are recommended.

- To ensure a good panel seal, gaskets are available as an optional extra.

### OPTION A MOUNT CUT-OUT AND INSTALLATION

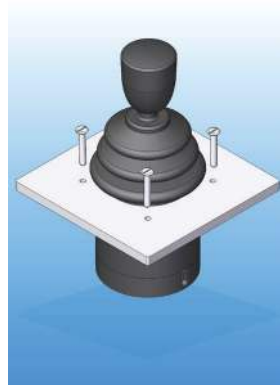
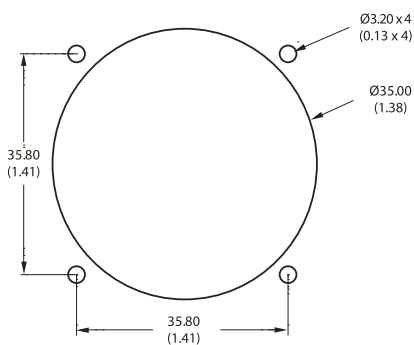

- When mounted this way the panel acts as the bezel and no separate bezel is needed.

- M3 machine screws are recommended.

### OPTION B MOUNT CUT-OUT AND INSTALLATION

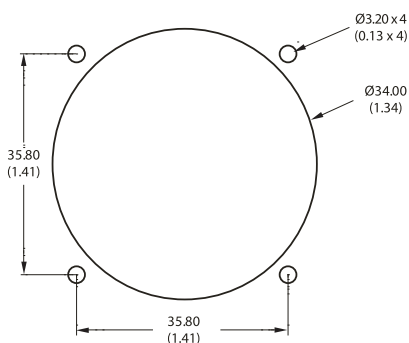

- The joystick flange is mounted beneath the panel and the base of the boot must be brought through the panel cut-out and held in place with the circular bezel (option 4).

- For panel thicknesses of up to 3 mm, m3 x 16 countersunk machine screws are recommended.

#### NOTES:

- When sub panel mounting, great care should be taken not to damage the boot, or any of the mechanism under the boot.
- All panel cut-outs should be free from sharp edges and swarf that may damage the boot.
- Some handles are larger than the recommended panel cut-out, in which case drop-in mounting must be specified.

# 8000 series

Rugged switch fingertip controllers • switching technology



## BUILD YOUR PART NUMBER

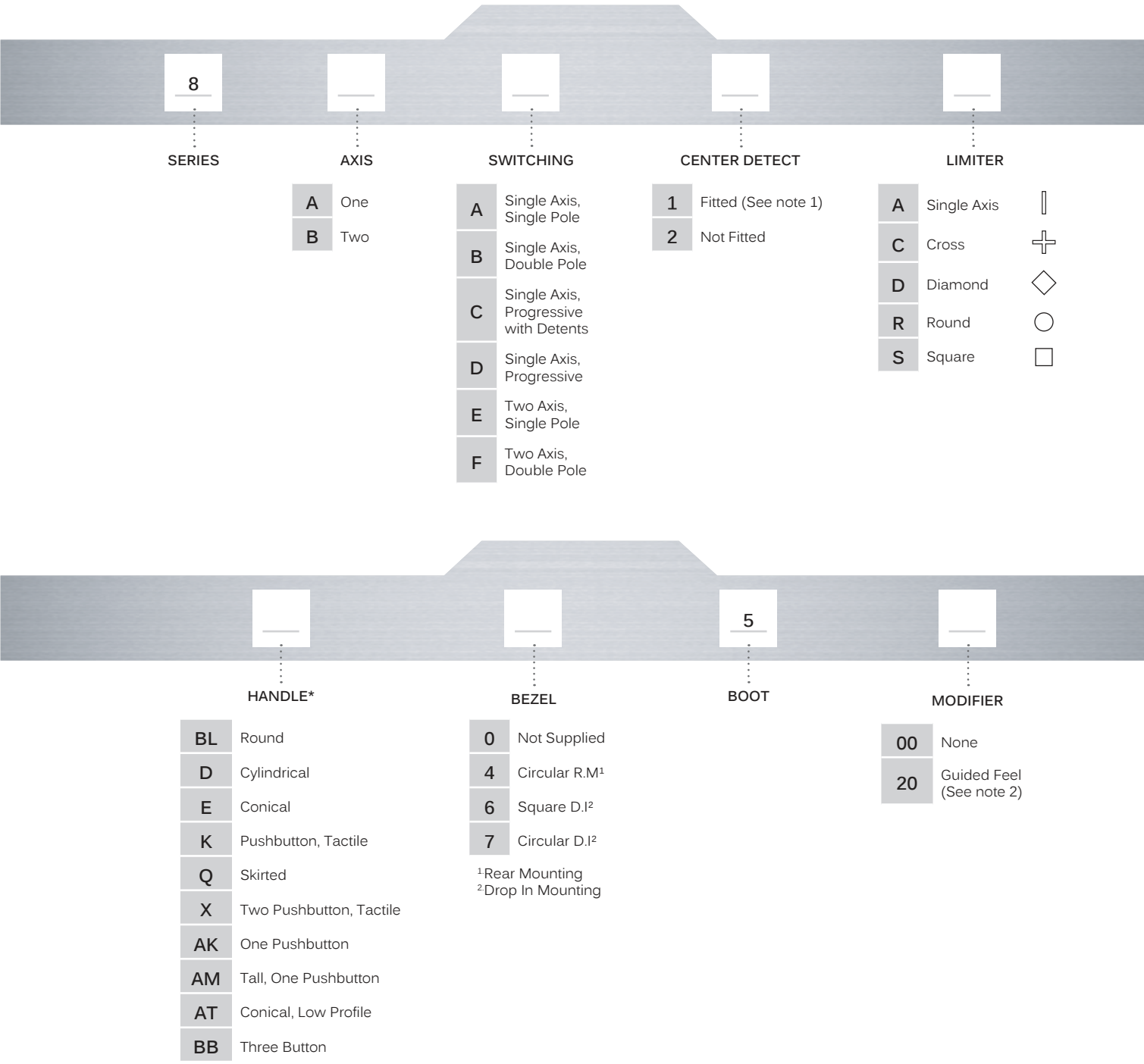

\*For more handles see [www.apem.com](http://www.apem.com)

### NOTES:

- <sup>1</sup> The additional center detect switch is not available on joysticks with progressive switching.
- <sup>2</sup> Guided feel is only available on two axis joysticks. Further non-standard options including custom handles, special limiters and detents are available. Please refer to APEM.
- <sup>3</sup> Only a square limiter will allow sufficient travel in a diagonal direction to activate both speed and steer switches.

# 8000 series

Rugged switch fingertip controllers • switching technology

## DIMENSIONS

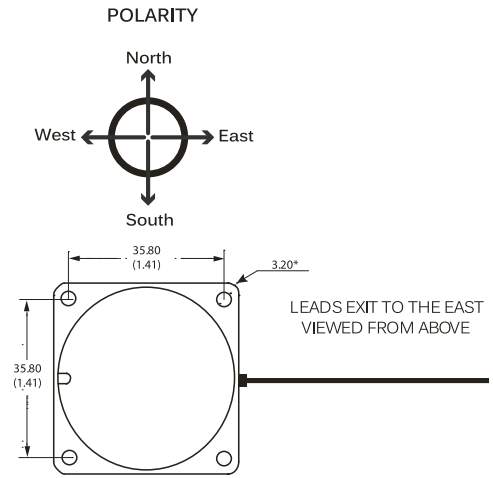
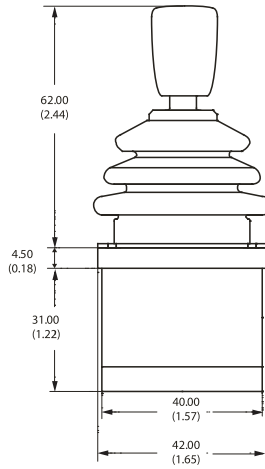

## HANDLE OPTIONS

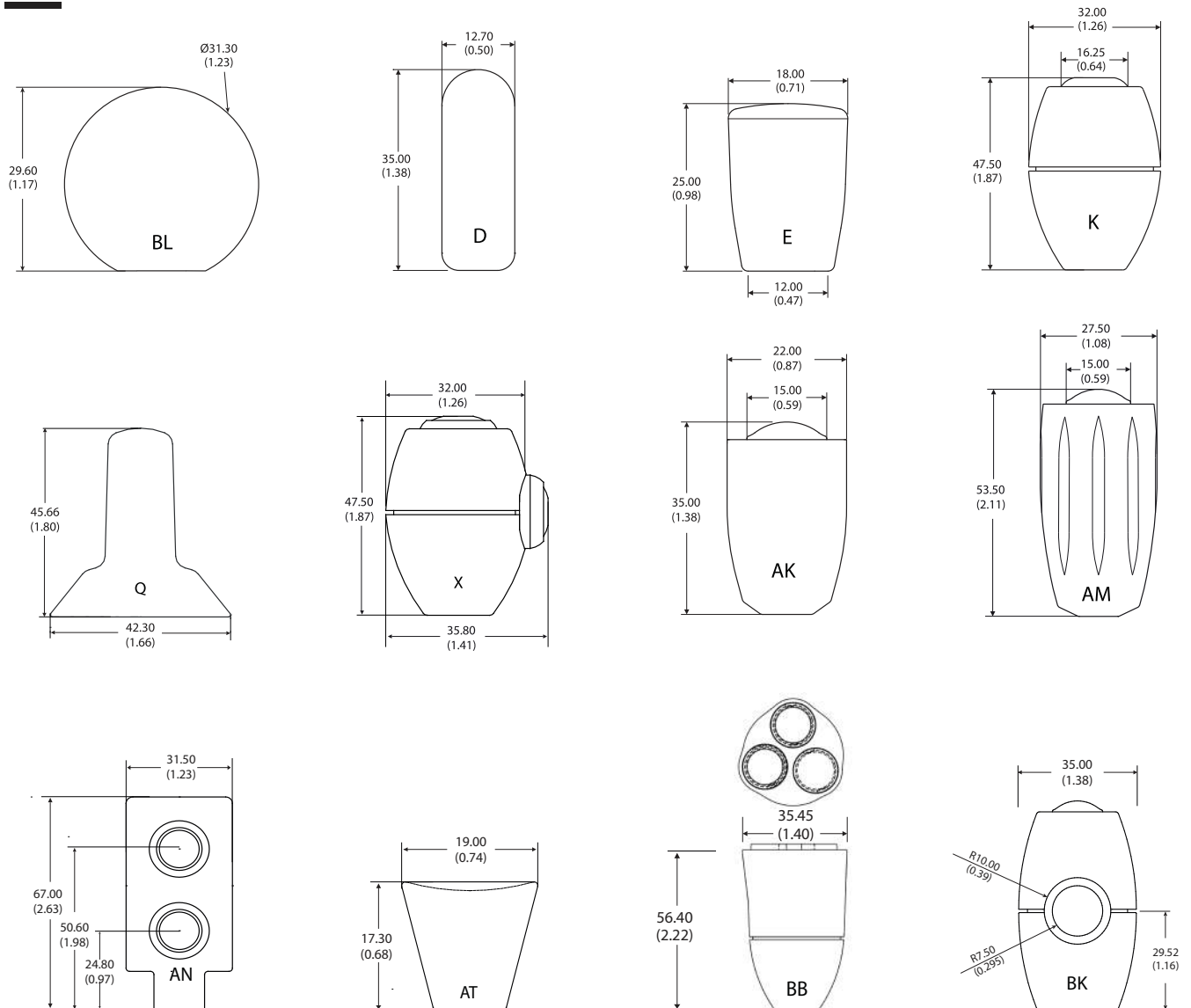

Rugged switch fingertip controllers • switching technology



## SWITCHING OPTIONS

### SINGLE AXIS CONFIGURATION

SWITCHING OPTION A

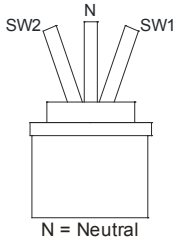

One switch will actuate as the joystick moves away from center in either direction.

SWITCHING OPTION B

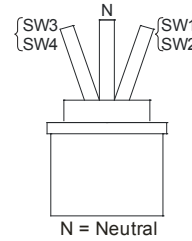

Two switches will actuate as the joystick moves away from center in either direction.

SWITCHING OPTION C

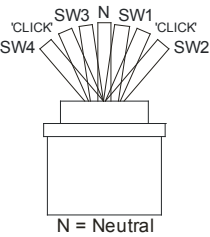

As per option D, but with a mechanical detent between actuation of the first and second switch.

SWITCHING OPTION D

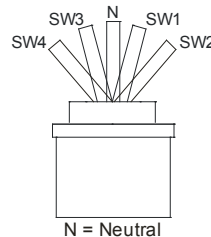

One switch will actuate after 50% of travel, with a further switch at the end of travel in either direction.

### TWO AXIS CONFIGURATION

SWITCHING OPTION E

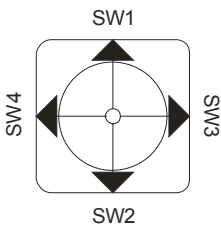

One switch will actuate in each of the four directions: North, South, East & West.

SWITCHING OPTION F

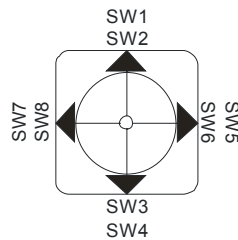

Two switches will actuate in each of the four directions: North, South, East & West.

The following configurations are available as standard :

- Single Axis - Single Pole : One switch in each of the the two directions; North & South.
- Single Axis - Double Pole : Two switches in each of the the two directions; North & South.
- Single Axis - Progressive : One switch will actuate after 8 degrees of movement, with a further switch actuating after another 10 degrees of movement, in either direction.
- Single Axis - Progressive with detents : As above, but with a mechanical detent at the point of the first switch actuation in each direction.
- Dual Axis - Single Pole : One switch in each of the four positions; North, South, East and West.
- Dual Axis - Double Pole : Two switches in each of the four positions; North, South, East and West.

Note : Double Pole switching is designed such that both switches in any given position trigger nominally together.

Many configurations are also available with a further microswitch actuating when the joystick is at center, for center detection purposes.

# 8000 series

Rugged switch fingertip controllers • switching technology



## CONFIGURATION OPTION

### MICROSWITCHES

The 8000 series utilizes industrial quality microswitches with changeover contacts. As standard, the switches are rated to a maximum of 1 Amp, and have gold plated silver contacts for reliable switching at low current levels.

Please note when specifying a joystick with a pushbutton handle the characteristics of the pushbutton will be different from the microswitches. Please refer to APEM for full details and characteristics of your chosen configuration.

### GUIDED FEEL

8000 series joysticks may also be specified with guided feel. A joystick with guided feel moves more readily towards the poles (North, South, East and West) and whilst it can still move away from the poles, the force required to do so is greater. Unless specified otherwise, joysticks are supplied as standard without guiding. This standard configuration allows the user to move the joystick anywhere within the limiter with the same force and without any bias.

### CABLE SPECIFICATION

As standard the joysticks are supplied utilizing the normally open contacts of the microswitches. For connection to the normally closed contacts, please specify this as part of your special modification.

Cable information may be subject to specification, please refer to APEM for details. Connectors and custom looms may be factory fitted upon request.

- 14/0.12 – Fourteen strands of 0.12 mm diameter tinned annealed copper wire PVC insulated, to a nominal OD of 1 mm

Red	Common
Blue	Second Switch West
Green	First Switch West
Orange	Second Switch North
Brown	First Switch North
Black	First switch East
Yellow	Second Switch East
Purple	First Switch South
White	Second Switch South
Gray	Center Detect Switch

- 7/0.127 – Seven strands of 0.127 mm diameter tinned copper wire ETFE insulated, to a nominal OD of 0.7 mm

Orange	First Pushbutton (Top of Handle)
Green	Second Pushbutton

NOTE: All 8000 series are supplied with 150 mm of twisted cable harness, with tinned ends.