



Overview

KEMET's Radial Solid Polymer Aluminum Capacitors offer longer life and greater stability across a wide range of temperatures. This highly conductive solid polymer electrolyte eliminates the risk of drying out and, due to its low ESR properties, is able to withstand higher ripple currents during normal operation. This series is ideally suited for industrial and commercial applications.

Applications

Typical applications include mobile phone chargers, adapters (laptop power supplies), and medical equipment.

Benefits

- Through-hole form factor
- Miniature
- Low impedance
- High ripple current
- Long life
- 105°C/5,000 hours
- RoHS compliant
- Halogen-free

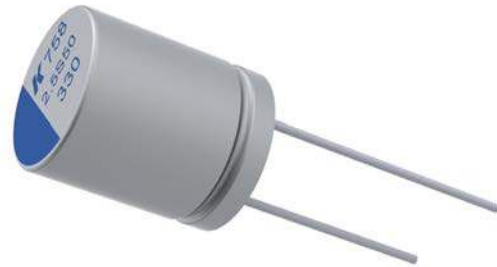

Part Number System

A	758	EK	337	M	0E	AA	E	018
Capacitor Class	Series	Size Code	Capacitance Code (pF)	Tolerance	Rated Voltage (VDC)	Packaging	Electrical Parameters	ESR
A = Aluminum	Radial Solid Polymer Aluminum Capacitors 105°C 5,000 hours Miniature	See Dimension Table	First two digits represent significant figures for capacitance values. Last digit specifies the number of zeros to be added.	M = ±20%	2.5 = 0E 4 = 0G 6.3 = 0J 10 = 1A 16 = 1C 25 = 1E	See Ordering Options Table	E = Standard/ESR	Last 3 digits represent significant figures for ESR values. (mΩ)

Ordering Options Table

Diameter	Packaging Type	Lead Type	Lead Length (mm)	Lead and Packaging Code
Standard Bulk Packaging Options				
5 - 18	Bulk (bag)	Long Lead (Loose Standard Leads)	15 Minimum	AA
5 - 18	Bulk (bag)	Cut Leads	5 ⁽¹⁾	BA
5 - 18	Bulk (bag)	Formed Leads	5 ⁽¹⁾	CA
Standard Auto-Insertion Packaging Options				
5	Ammo Tape and Box	Formed to 2.5 mm	H ₀ = 16±0.5	FA
5 - 8	Ammo Tape and Box	Formed to 5 mm	H ₀ = 16±0.5	DA
6 - 8	Ammo Tape and Box	Straight	H = 18.5±0.5 (for 8 x 12 H = 20±0.5)	EA
10 - 13	Ammo Tape and Box	Straight	H = 18.5±0.5	EA
Contact KEMET for other Lead and Packaging options ⁽¹⁾ Contact KEMET for custom Lead Length and options 3 to 10 mm				

Size Code	Dimensions DxL	Lead and Packaging Code (SPQ)			
		AA Bulk (Bag)	BA Bulk (Bag)	CA Bulk (Bag)	DA, EA, FA Ammo, Tape and Box
BG	5x7	1,000	1,000	1,000	2,000
BK	5x8	1,000	1,000	1,000	2,000
BM	5x9	1,000	1,000	1,000	2,000
BQ	5x11	1,000	1,000	1,000	2,000
EA	6.3x5	1,000	1,000	1,000	1,500
EK	6.3x8	1,000	1,000	1,000	1,500
EM	6.3x9	1,000	1,000	1,000	1,500
EQ	6.3x11	1,000	1,000	1,000	1,500
KK	8x8	500	500	500	1,000
KR	8x11.5	500	500	500	1,000
KS	8x12	500	500	500	1,000
KV	8x14	500	500	500	1,000
KW	8x16	500	500	500	1,000
MS	10x12	250	250	250	600
MU	10x12.5	250	250	250	600
MV	10x14	250	250	250	600
MW	10x16	250	250	250	600

Long Lead (Loose Standard Leads)

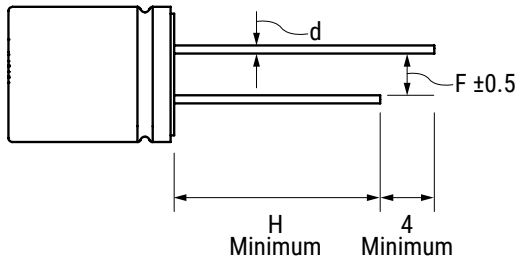

	Diameter					
	5	6.3	8	10	13	18
d	0.5	0.5	0.6	0.6	0.6	0.8
F	2	2.5	3.5	5	5	7.5
H	15	15	15	15	15	15

Cut Lead

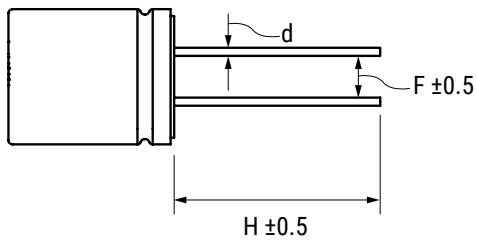

	Diameter					
	5	6.3	8	10	13	18
d	0.5	0.5	0.6	0.6	0.6	0.8
F	2	2.5	3.5	5	5	7.5
H	According to customer requirement 3 – 10 mm					

Formed Lead

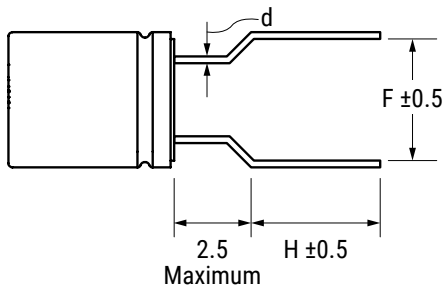

	Diameter					
	5	6.3	8	10	13	18
d	0.5	0.5	0.6	0.6	0.6	0.8
F	5	5	5	5	5	5
H	According to customer requirement 3 – 10 mm					

Dimensions – Millimeters

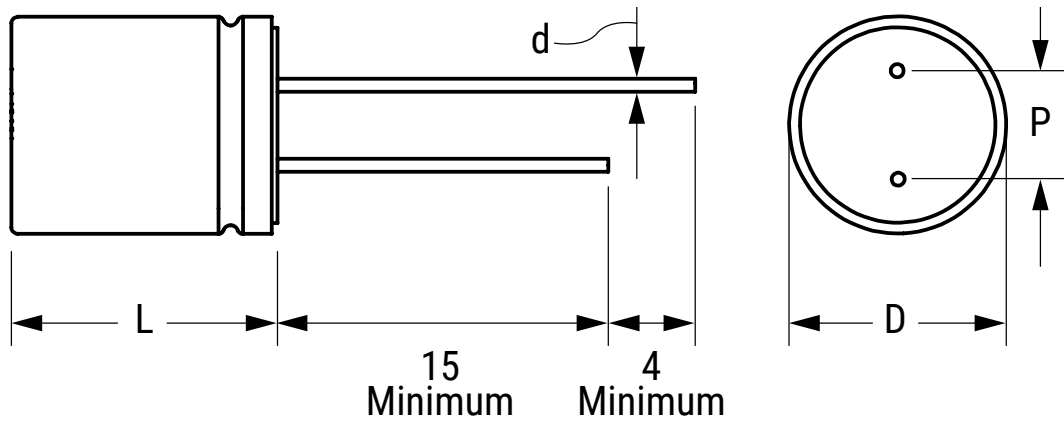

Size Code	D		L		d		P	
	Nominal	Tolerance	Nominal	Tolerance	Nominal	Tolerance	Nominal	Tolerance
BG	5	±0.5	7	±1.0	0.5	±0.05	2.0	±0.5
EK	6.3	±0.5	8	±1.0	0.5	±0.05	2.5	±0.5
KK	8	±0.5	8	±1.0	0.6	±0.05	3.5	±0.5
KR	8	±0.5	11.5	±1.5	0.6	±0.05	3.5	±0.5
MU	10	±0.5	12.5	±1.5	0.6	±0.05	5.0	±0.5

Performance Characteristics

Item	Performance Characteristics
Capacitance Range	10 – 1,200 μF
Rated Voltage	2.5 – 25 VDC
Operating Temperature	-55°C to +105°C
Capacitance Tolerance	±20% at 120 Hz/20°C
Life Test	5,000 hours (see conditions in Test Method & Performance)
Leakage Current	$I \leq 0.15 \text{ CV}$ or 120 μA , whichever is greater C = Rated capacitance (μF), V = Rated voltage (VDC), Voltage applied for 2 minutes at 20°C.

Dissipation Factor ($\tan \delta$)

Rated Voltage (V)	2.5 – 25
$\tan \delta$ (Maximum) at 120 Hz/20°C	0.10

Compensation Factor of Ripple Current (RC) vs. Frequency

Frequency	120 Hz ≤ f < 1 kHz	1 kHz ≤ f < 10 kHz	10 kHz ≤ f < 100 kHz	100 kHz ≤ f < 500 kHz
Coefficient	0.05	0.30	0.70	1.00

Test Method & Performance

Conditions	Load Life Test	Shelf Life Test
Temperature	105°C	105°C
Test Duration	5,000 hours	96 hours
Ripple Current	No ripple current applied	No ripple current applied
Voltage	The sum of DC voltage and the peak AC voltage must not exceed the rated voltage of the capacitor	No voltage applied
Performance	The following specifications will be satisfied when the capacitor is restored to 20°C.	
Capacitance Change	Within ±20% of the initial value	
Dissipation Factor	Does not exceed 150% of the specified value	
ESR	Does not exceed 150% of the specified value	
Leakage Current	Does not exceed specified value	
Damp Heat	The following specifications will be satisfied when the capacitor is restored to 20°C after application of rated voltage for 1,000 hours at 60°C, 90%~95% RH.	
Capacitance Change	Within ±20% of the initial value	
Dissipation Factor	Does not exceed 150% of the specified value	
ESR	Does not exceed 150% of the specified value	
Leakage Current	Does not exceed specified value	
Surge Voltage (Rated Voltage x 1.15 (V))	The following specifications will be satisfied when the capacitor is subjected to 1,000 cycles each consisting of charge with the surge voltages specified at 105°C for 30 seconds through a protective resistor (Rc = 1 kΩ) and discharge for 5 minutes 30 seconds.	
Capacitance Change	Within ±20% of the initial value	
Dissipation Factor	Does not exceed 150% of the specified value	
ESR	Does not exceed 150% of the specified value	
Leakage Current	Does not exceed specified value	

Shelf Life and Re-Ageing

Shelf Life

Solderability is 12 months

The capacitance, ESR and impedance of a capacitor will not change significantly after extended storage periods, however the leakage current will slowly increase.

- This series should not be stored in high temperatures or where there is a high level of humidity.
- The suitable storage condition is +5 to +35°C and less than 75% in relative humidity.
- Do not store in damp conditions such as water, saltwater spray or oil spray.
- Do not store in an environment full of hazardous gas (hydrogen sulphide, sulphurous acid gas, nitrous acid, chlorine gas, ammonium, etc.)
- Do not store under exposure to ozone, ultraviolet rays or radiation.

If a capacitor has been stored for more than 24 months under these conditions and it shows increased leakage current, then a treatment by voltage application is recommended.

Re-age Procedure

Apply the rated DC voltage to the capacitor at 105°C for a period of 120 minutes through a 1 kΩ series resistor.

Environmental Compliance



All Part Numbers in this datasheet are Reach and RoHS compliant, and Halogen-Free.

As an environmentally conscious company, KEMET is working continuously with improvements concerning the environmental effects of both our capacitors and their production. In Europe (RoHS Directive) and in some other geographical areas like China, legislation has been put in place to prevent the use of some hazardous materials, such as lead (Pb), in electronic equipment. All products in this catalog are produced to help our customers' obligations to guarantee their products and fulfill these legislative requirements. The only material of concern in our products has been lead (Pb), which has been removed from all designs to fulfill the requirement of containing less than 0.1% of lead in any homogeneous material. KEMET will closely follow any changes in legislation worldwide and makes any necessary changes in its products, whenever needed.

Some customer segments such as medical, military and automotive electronics may still require the use of Lead in electrode coatings. To clarify the situation and distinguish products from each other, a special symbol is used on the packaging labels for RoHS compatible capacitors.

Due to customer requirements, there may appear additional markings such as LF = Lead-free, or LFW = Lead-free wires on the label.

Table 1 – Ratings & Part Number Reference

VDC	VDC Surge Voltage	Rated Capacitance 120 Hz 20°C (µF)	Case Size D x L (mm)	ESR 100 kHz 20°C (mΩ)	RC 100 kHz 105°C (mA)	LC 20°C 2 minutes (µA)	KEMET Part Number
2.5	2.9	330	6.3 x 8	18	3,100	124	A758EK337M0E(1)E018
2.5	2.9	390	6.3 x 8	18	3,100	146	A758EK397M0E(1)E018
2.5	2.9	470	6.3 x 8	18	3,100	176	A758EK477M0E(1)E018
2.5	2.9	560	6.3 x 8	16	3,100	210	A758EK567M0E(1)E016
2.5	2.9	680	8 x 8	16	4,100	255	A758KK687M0E(1)E016
2.5	2.9	820	8 x 8	15	4,100	308	A758KK827M0E(1)E015
2.5	2.9	1,000	8 x 8	15	4,500	375	A758KK108M0E(1)E015
2.5	2.9	1,200	8 x 8	14	4,500	450	A758KK128M0E(1)E014
4	4.6	220	5 x 7	20	2,500	132	A758BG227M0G(1)E020
4	4.6	270	5 x 7	20	2,500	162	A758BG277M0G(1)E020
4	4.6	330	6.3 x 8	18	3,100	198	A758EK337M0G(1)E018
4	4.6	560	6.3 x 8	16	3,100	336	A758EK567M0G(1)E016
4	4.6	680	8 x 8	16	4,100	408	A758KK687M0G(1)E016
4	4.6	820	8 x 8	15	4,100	492	A758KK827M0G(1)E015
6.3	7.2	180	5 x 7	18	2,500	170	A758BG187M0J(1)E018
6.3	7.2	220	5 x 7	18	2,500	208	A758BG227M0J(1)E018
6.3	7.2	270	6.3 x 8	18	2,900	255	A758EK277M0J(1)E018
6.3	7.2	330	6.3 x 8	16	3,100	312	A758EK337M0J(1)E016
6.3	7.2	390	6.3 x 8	16	3,100	369	A758EK397M0J(1)E016
6.3	7.2	470	6.3 x 8	15	3,100	444	A758EK477M0J(1)E015
6.3	7.2	560	8 x 8	14	4,100	529	A758KK567M0J(1)E014
6.3	7.2	680	8 x 8	14	4,100	643	A758KK687M0J(1)E014
6.3	7.2	820	8 x 8	13	4,900	775	A758KK827M0J(1)E013
10	11.5	100	6.3 x 8	16	2,000	150	A758EK107M1A(1)E016
10	11.5	150	6.3 x 8	16	2,500	225	A758EK157M1A(1)E016
10	11.5	180	6.3 x 8	16	2,500	270	A758EK187M1A(1)E016
10	11.5	220	8 x 8	14	4,800	330	A758KK227M1A(1)E014
10	11.5	470	8 x 11.5	11	5,100	940	A758KR477M1A(1)E011
10	11.5	560	8 x 11.5	11	5,100	1120	A758KR567M1A(1)E011
10	11.5	680	8 x 11.5	8	5,650	1360	A758KR687M1A(1)E008
16	18.4	100	6.3 x 8	18	2,900	240	A758EK107M1C(1)E018
16	18.4	150	8 x 8	15	4,100	360	A758KK157M1C(1)E015
16	18.4	180	8 x 8	14	4,550	432	A758KK187M1C(1)E014
16	18.4	220	8 x 8	14	4,800	528	A758KK227M1C(1)E014
16	18.4	270	8 x 11.5	11	5,000	864	A758KR277M1C(1)E011
16	18.4	470	10 x 12.5	10	6,100	1504	A758MU477M1C(1)E010
25	28.8	10	5 x 7	70	750	120	A758BG106M1E(1)E070
25	28.8	22	6.3 x 8	50	2,000	120	A758EK226M1E(1)E050
25	28.8	33	6.3 x 8	40	3,100	124	A758EK336M1E(1)E040
VDC	VDC Surge	Rated Capacitance	Case Size	ESR	RC	LC	Part Number

(1) Please see packaging codes for options.

(2) Electrical Parameters code. See Part Number System for available options.

Installing

Solid Polymer Aluminum Capacitors are prone to a change in leakage current due to thermal stress during soldering. The leakage current may increase after soldering or reflow soldering. Therefore, verify the suitability for use in circuits sensitive to leakage current.

A general principle is that lower temperature operation results in a longer, useful life of the capacitor. For this reason, it should be ensured that electrolytic capacitors are placed away from heat-emitting components. Adequate space should be allowed between components for cooling air to circulate, especially when high ripple current loads are applied. In any case, the maximum rated temperature must not be exceeded.

- Do not deform the case of capacitors or use capacitors with a deformed case.
- Verify that the connections of the capacitors are able to insert on the board without excessive mechanical force. Excessive force during insertion, as well as after soldering may cause terminal damage and affect the electrical performance.
- Ensure electrical insulation between the capacitor case, negative terminal, positive terminal and PCB.
- If the capacitors require mounting through additional means, the recommended mounting accessories shall be used.
- Verify the correct polarization of the capacitor on the board.

KEMET recommends, to ensure that the voltage across each capacitor does not exceed its rated voltage.

Temperature Stability Characteristics

Stable characteristics in a very low temperature range allows for less circuits in the design.

Due to a solid polymer electrolyte, Solid Polymer Aluminum Capacitors feature higher conductivity. This results in a lower ESR which, coupled with high capacitance allows an aluminum polymer capacitor to replace several standard electrolytic capacitors, reducing the number of components and maximizing board space.

The ESR of polymer capacitors is nearly constant within its operating temperature range, while the ESR of a standard electrolytic capacitor noticeably changes with temperature.

Temperature Stability Characteristics

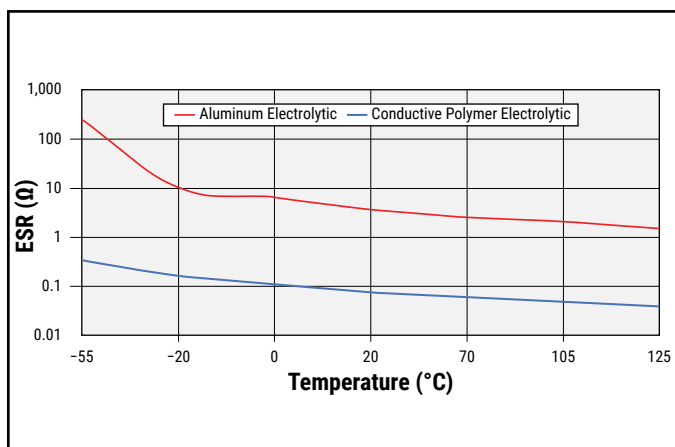

Expected Life Calculation Chart

Expected life depends on operating temperature according to the following formula:

$$L = L_0 \times 10^{(T_0 - T)/20}$$

Where:

L: Expected life

L₀: Life at maximum permissible operating temperature with rated operating voltage applied (hours)

T: Actual operating temperature

T₀: Maximum permissible operating temperature

Expected Life Calculation Chart

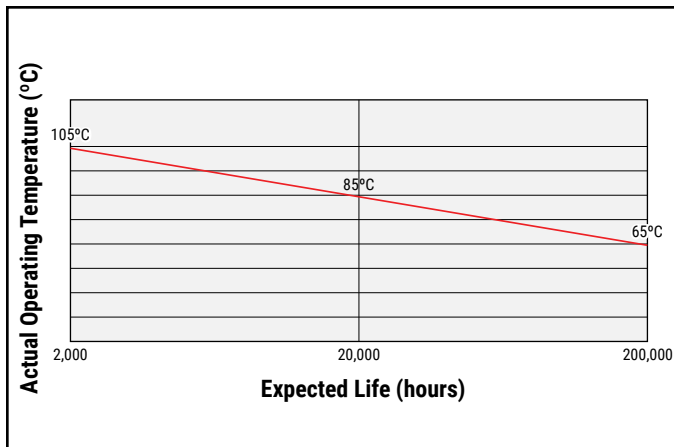

The effect of derating temperature can be seen in this graph.

In this example, the life expectancy of a 2,000 hour Polymer capacitor is significantly greater than that of a 2,000 hour standard electrolytic capacitor.

Capacitor Life (H)

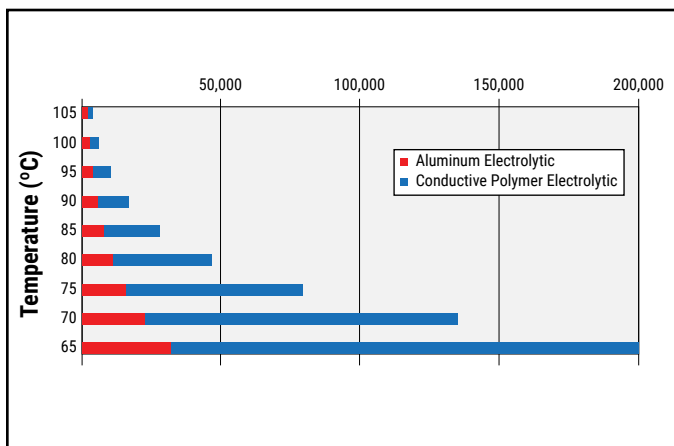

Stability of ESR across Frequency Range

Due to a solid polymer electrolyte, the ESR curve of a solid polymer aluminum capacitor, is lower and more stable than that of a standard electrolytic capacitor.

Stable ESR Values across Frequency

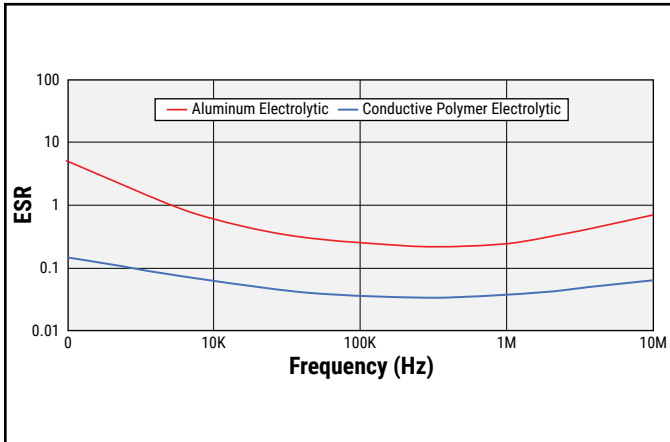

High Resistance to Ripple Current

As a result of a lower ESR, solid polymer aluminum capacitors are able to withstand higher ripple currents during normal operation.

Allowable Ripple Current (100 kHz 105°C)

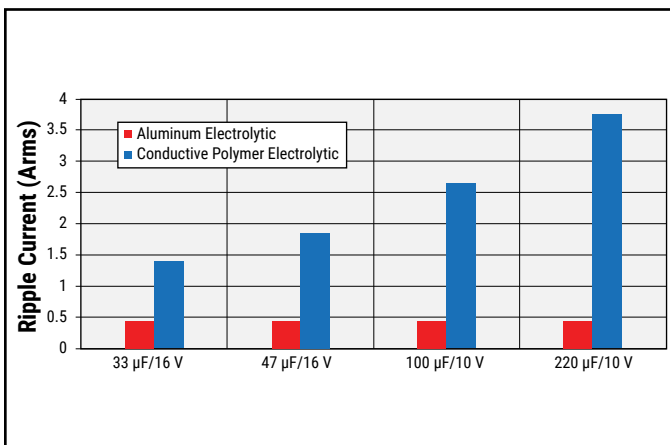

Marking

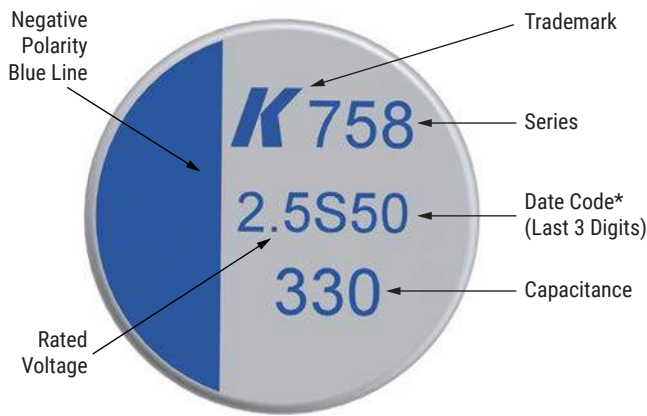

Date Code*	
1 st Digits = Rated Voltage	
Letter = Year Code	S = 2019
Final Digits = Week of the Year	01 = 1 st week of the Year to 52 = 52 nd week of the Year
Year Code	
S	2019
T	2020
U	2021
V	2022
W	2023
X	2024
Y	2025
Z	2026

Construction

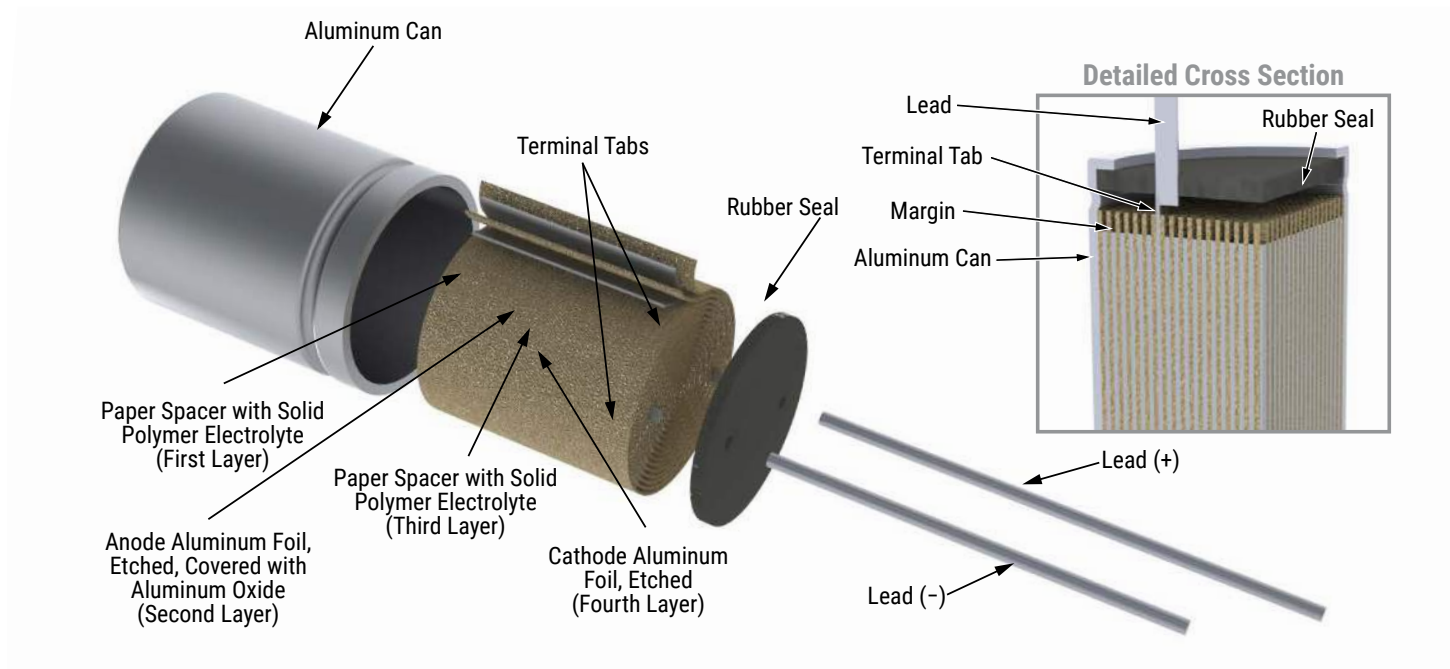

Flow Soldering (not suitable for SMD parts)

The soldering conditions should be within the specified conditions below:

- Do not dip the capacitors body into the melted solder.
- Flux should only be applied to the capacitors terminals.
- Vapour heat transfer systems are not recommended. The system should be thermal, such as infra-red radiation or hot blast.
- Observe the soldering conditions as shown below.
- Do not exceed these limits and avoid repeated reflowing.

Flow Soldering

	Temperature (°C)	Maximum Time (Seconds)	Maximum Repetitions
Pre-heat	< 120	< 120	1
Solder	260±5°C	< 10	2

Taping for Automatic Insertion Machines

Fig. 1 (Diameter $\Phi 5$) 5 mm formed to 2.5 mm FA

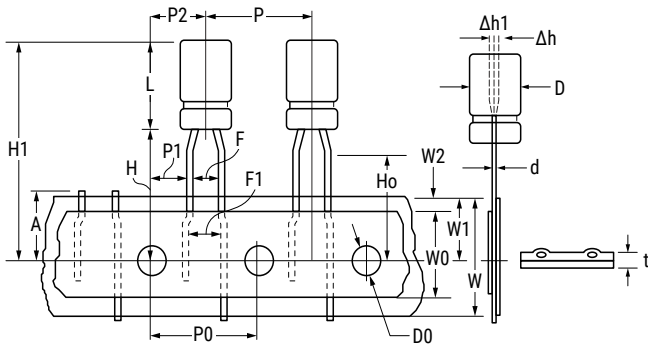

Fig. 2 (Diameter for $\Phi 5$ to $\Phi 8$) 5 – 8 mm formed to 5 mm DA

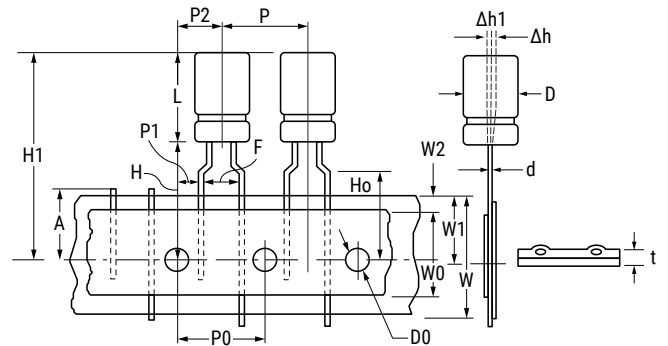

Fig. 3 (Diameter for $\Phi 6$ to $\Phi 8$) 6 – 8 mm EA

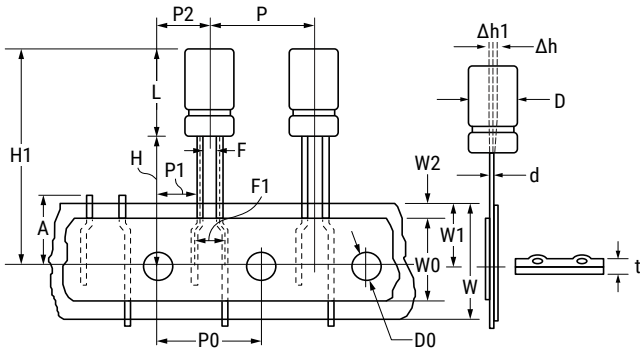
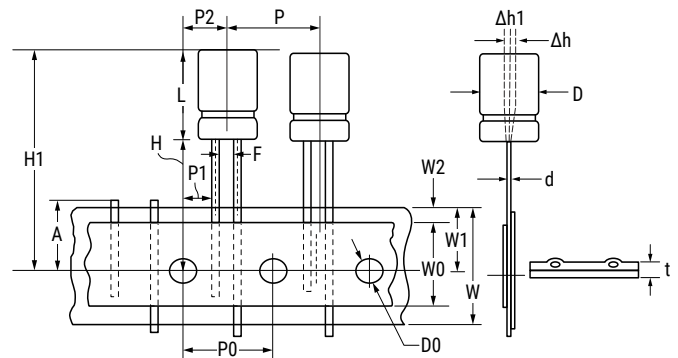

Fig. 4 (Diameter for $\Phi 10$) 10 mm EA



Dimensions (mm)	D	L	d	P	P0	P1	P2	F	W	W0	W1	W2	H	Ho	D0	A	H1	Δh	$\Delta h1$	t
Tolerance	± 0.5		± 0.02	± 1.0	± 0.2	± 0.7	± 1.0	± 0.5	± 0.5	min	± 0.5	max	± 0.75	± 0.5	± 0.2	Max.	Max.	± 2	± 1	± 0.3
Formed to 2.5 mm	5	7.0 9-11	0.5	12.7	12.7	5.1	6.35	2.5	18	12.5	9	1.5	17.5	16						
Formed to 5 mm	5	7-11	0.5	12.7	12.7	3.85	6.35	5	18	12.5	9	1.5	18.5	16			32.5			
	6.3	8-11																		
Straight leads 6 – 8 mm	8	8.0 12.0	0.6	12.7	12.7	5.4	6.35	2.5	18	12.5	9	1.5	18.5		4	11		0	0	0.7
	8	8.0 12.0	0.6					3.5					20							
Straight leads 10 – 13 mm	10	12	0.6	12.7	12.7	3.85	6.35	5	18	12.5	9	1.5	18.5	--			33			
		16.0															36			
		18.0															41			
		20.0															40.5			
	13	20.0		15	15	5	7.5													

Construction Data

The manufacturing process begins with the anode foil being electrochemically etched to increase the surface area and then 'formed' to produce the aluminum oxide layer. Both the anode and cathode foils are then interleaved with absorbent paper and wound into a cylinder. During the winding process, aluminum tabs are attached to each foil to provide the electrical contact.

The deck, complete with terminals, is attached to the tabs and then folded down to rest on top of the winding. The complete winding is impregnated with a conductive polymer electrolyte before being housed in a suitable container, usually an aluminum can, and sealed. Throughout the process, all materials inside the housing must be maintained at the highest purity and be compatible with the electrolyte.

Each capacitor is aged and tested before being packed. The purpose of aging is to repair any damage in the oxide layer and thus reduce the leakage current to a very low level. Aging is normally carried out at the rated temperature of the capacitor and is accomplished by applying voltage to the device while carefully controlling the supply current. The process may take several hours to complete. Damage to the oxide layer can occur due to variety of reasons:

- Slitting of the anode foil after forming
- Attaching the tabs to the anode foil
- Minor mechanical damage caused during winding

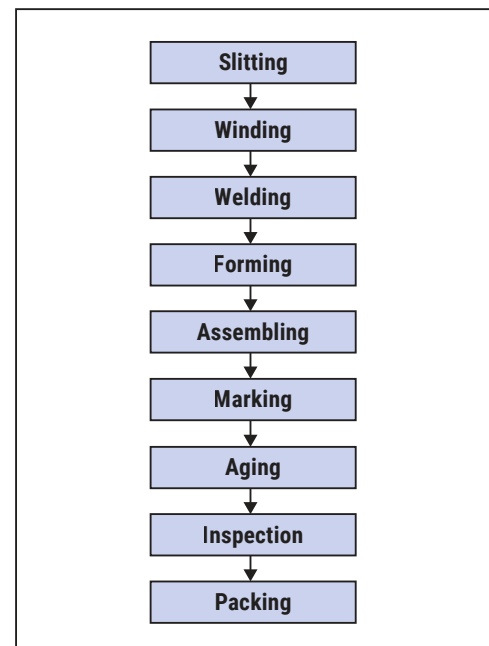
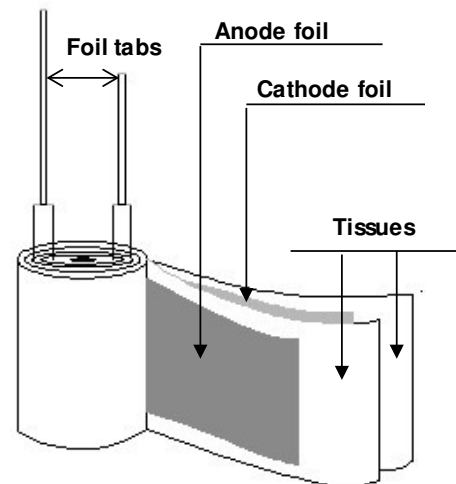

Product Safety

THESE NOTES SHOULD BE READ IN CONJUNCTION WITH THE PRODUCT DATA SHEET. FAILURE TO OBSERVE THE RATINGS AND THE INFORMATION ON THIS SHEET MAY RESULT IN A SAFETY HAZARD.

Warning

When potential lethal voltages e.g. 30 VAC (RMS) or 60 VDC are applied to the terminals of this product, the use of a hazard warning label is recommended.

1. Electrolyte

Conductive polymer aluminum solid electrolytic capacitors contain polymers (electrolytes) which can be hazardous.

1.1 Safety Precautions

In the event of gas venting, avoid contact and inhalation. Wash the affected area with hot water. Use rubber gloves to avoid skin contact. Any contact with the eyes should be liberally irrigated with water and medical advice sought.

2. Intrinsic Properties

2.1 Operating

DC capacitors are polar devices and will operate safely only if correctly connected. Reversing the connections will result in high leakage currents which could subsequently cause short circuit failure and possibly explosion and fire. Correctly polarized operation may result in the above failure modes if:

- The surge voltage is exceeded
- The ambient temperature is too high
- Excessive ripple currents are applied

2.2 Non-Operating

Excessive torque or soldering heat may affect the performance of the capacitor or damage the sealing. Electric shock may result if capacitors are not discharged.

3. Disposal

Aluminum electrolytic capacitors are consignable waste under the Special Waste Regulations 1996 (Statutory Instrument 1996 No 972), which complies with the EC Hazardous Waste Directive – Directive 91/689/EEC. The electrolyte should therefore be treated as a hazardous waste and advice should be sought from the local office of the Environmental Agency regarding its disposal.

Due to the construction of an aluminum electrolytic capacitors, high temperature incineration may cause the component to explode due to build-up of internal pressure. In addition, incineration may also cause the emission of noxious fumes. KEMET strongly recommends that if there are any doubts regarding the disposal of conductive polymer aluminum solid electrolytic capacitors, that advice be sought from the local regulating authority.

In addition, KEMET would like to request that users of aluminum electrolytic capacitors respect the needs of the environment and, wherever possible, recover as much of the materials as possible, i.e. aluminum.

Product Safety cont.

4. Unsafe Use

Most failures are of a passive nature and do not represent a safety hazard. A hazard may, however, arise if this failure causes a dangerous malfunction of the equipment in which the capacitor is employed. Circuits should be designed to fail safe under the normal modes of failure.

The usual failure mode is an increase in leakage current or short circuit. Other possible modes are decrease of capacitance, increase in dissipation factor (and impedance) or an open circuit. Capacitors should be used in a well-ventilated enclosure or cabinet.

5. Fumigation

In many countries throughout the world it is now common practice to fumigate shipments of products in order to control insect infestation, particularly when wooden packaging is used. Currently, methyl bromide is widely used as a fumigant, which can penetrate cardboard packing and polymer bags and, therefore, come into direct contact with equipment or components contained within.

If aluminum electrolytic capacitors become exposed to methyl bromide then corrosion may occur, depending upon the concentration and exposure time to the chemical.

This failure mode can affect all types of KEMET aluminum electrolytic capacitors. Methyl bromide can penetrate the seals of aluminum electrolytic capacitors and cause internal corrosion of the anode connection, resulting in the component becoming open circuit. The rate of corrosion will depend upon the level of exposure to methyl bromide as well as the subsequent operating conditions, such as voltage and temperature. It may take months or, in some cases, several years before the component becomes open circuit.

6. Dielectric Absorption

A phenomenon known as dielectric absorption can cause aluminum electrolytic capacitors to recharge themselves. The phenomenon is well known but impossible to predict with any great accuracy, so potentially any electrolytic product could be affected. Thus, a capacitor that has been charged and then completely discharged will appear to recharge itself if left open circuit; this will manifest itself as a small voltage across the terminals of the capacitor. Generally, the voltages seen are less than 20 VDC. However, higher voltages have on occasion been reported.

In order to avoid any problems caused by this voltage, KEMET recommends that capacitors be discharged before connecting to the terminals.

KEMET Electronics Corporation Sales Offices

For a complete list of our global sales offices, please visit www.kemet.com/sales.

Disclaimer

YAGEO Corporation and its affiliates do not recommend the use of commercial, automotive, and/or COTS grade products for high reliability applications or manned space flight.

All product specifications, statements, information and data (collectively, the "Information") in this datasheet are subject to change. The customer is responsible for checking and verifying the extent to which the Information contained in this publication is applicable to an order at the time the order is placed. All Information given herein is believed to be accurate and reliable, but it is presented without guarantee, warranty, or responsibility of any kind, expressed or implied.

Statements of suitability for certain applications are based on KEMET Electronics Corporation's ("KEMET") knowledge of typical operating conditions for such applications, but are not intended to constitute – and KEMET specifically disclaims – any warranty concerning suitability for a specific customer application or use. The Information is intended for use only by customers who have the requisite experience and capability to determine the correct products for their application. Any technical advice inferred from this Information or otherwise provided by KEMET with reference to the use of KEMET's products is given gratis, and KEMET assumes no obligation or liability for the advice given or results obtained.

Although KEMET designs and manufactures its products to the most stringent quality and safety standards, given the current state of the art, isolated component failures may still occur. Accordingly, customer applications which require a high degree of reliability or safety should employ suitable designs or other safeguards (such as installation of protective circuitry or redundancies) in order to ensure that the failure of an electrical component does not result in a risk of personal injury or property damage.

Although all product-related warnings, cautions and notes must be observed, the customer should not assume that all safety measures are indicated or that other measures may not be required.

KEMET requires its products to be packaged and shipped on pallets. This is because KEMET's products are specifically designed to be packed onto pallets during shipment. If for any reason, the products are removed from pallets by the shipping party and shipped to the end customer, then additional external protection is required. In this instance, an external box with two carton layers and an upwards orientation sticker must be used by the shipping party, with the empty space filled with filling material, and afterwards sealing the box. If this packing and packaging guideline is not followed by the shipping party, the shipping party, and not KEMET, will be held responsible for any packaging, packing and/or product damages upon delivery of the products to the end customer. KEMET hereby disclaims any liability for damages to the products or otherwise that have been, or threaten to be, inflicted, result from or are in any way related to the packaging, packing or damage by the shipping party in contravention of the packing and packaging guidelines herein.

KEMET is a registered trademark of KEMET Electronics Corporation.