

# Application Note

Surface Molding Series Regulator IC

**SI-3000KM series**

*Not Recommended for New Designs:  
SI-3025KM, SI-3050KM*

Jun 2015 Rev.2.0

SANKEN ELECTRIC CO., LTD.

— — — Contents — — —

1. General Description		
1-1 Features	-----	3
1-2 Application	-----	3
1-3 Type	-----	3
2. Specification		
2-1 Package Information	-----	4
2-2 Ratings	-----	5
2-3 Circuit Diagram	-----	10
3. Operational Description		
3-1 Voltage Control	-----	12
3-2 Overcurrent Protection	-----	12
3-3 Thermal Shutdown	-----	13
4. Cautions		
4-1 External Components	-----	14
4-2 Pattern Design Notes	-----	15
5. Applications		
5-1 Output ON / OFF Control	-----	16
5-2 Thermal Design	-----	16
6. Typical Characteristics		
6-1 SI-3012KM	-----	18
6-2 SI-3010KM	-----	20

## 1. General Description

The SI-3000KM is a series regulator IC using a hyposaturation type PNP bipolar transistor in the power section and it can be used with the low difference of input/output voltages. It is provided with an ON / OFF terminal which operates in Active High mode and the current consumption of circuits at OFF time is zero.

### ● 1-1 Features

- Output current 1A  
Output current is 1A at maximum with the outline of TO-252-5L.
- Hyposaturation ( $V_{dif} = 0.6 V_{max} / I_o = 1A$ )  
It can be designed with low difference of input/output voltages.
- ON/OFF function  
The ON/OFF terminal which can be directly controlled by TLL logic signals is provided.
- Low current consumption  
Current consumption of circuits at OFF time is zero.  
Quiescent Current at no load is  $600\mu A$  at maximum.
- High ripple attenuation ratio  
 $75dB: F = 100 - 120kHz$  at  $V_o = 5V$
- Built-in Overcurrent protection / Thermal shutdown  
The automatic restoration and Foldback type overcurrent protection and Thermal shutdown circuit are built in.

### ● 1-2 Application

For on-board local power supplies, power supplies for OA equipment, stabilization of secondary output voltage of regulator and power supply for communication equipment

### ● 1-3 Type

- Type: Semiconductor integrated circuits (monolithic IC)
- Structure: Resin molding type (transfer molding)

Not Recommended for New Designs:  
SI-3025KM, SI-3050KM



## ● 2-2 Ratings

### 2-2-1 Absolute Maximum Ratings

Ta = 25°C

Parameter	Symbol	Ratings		Units
		SI-3012KM/3025KM /3033KM	SI-3010KM/2050KM /3090KM/3120KM	
DC Input Voltage	V <sub>IN</sub>	17	35* <sup>1</sup>	V
Output Control Terminal Voltage	V <sub>C</sub>	V <sub>IN</sub>		V
DC Output Current	I <sub>o</sub>	1.0		A
Power Dissipation	PD* <sup>2</sup>	1		W
Junction Temperature	T <sub>j</sub>	-30 to +125		°C
Storage Temperature	T <sub>stg</sub>	-30 to +125		°C
Thermal Resistance (Junction to Air)	θ <sub>j-a</sub>	95		°C/W
Thermal Resistance (Junction to Case)	θ <sub>j-c</sub>	6		°C/W

\*1: A built-in input-overvoltage-protection circuit shuts down the output voltage at the Input Overvoltage Shutdown Voltage of the electrical characteristics.

\*2: When mounted on glass-epoxy board of 900mm<sup>2</sup> (copper laminate area 4.3%).

### 2-2-2 Recommended Conditions

Parameter	Symbol	Ratings							Units
		SI-3012KM	SI-3025KM	SI-3033KM	SI-3010KM	SI-3050KM	SI-3090KM	SI-3120KM	
Input Voltage	V <sub>IN</sub>	2.4* <sup>2</sup> to 6.0* <sup>1</sup>	2.4* <sup>2</sup> to 5.0* <sup>1</sup>	* <sup>2</sup> to 6.0* <sup>1</sup>	2.4* <sup>2</sup> to 27* <sup>1</sup>	2.4* <sup>2</sup> to 17* <sup>1</sup>	* <sup>2</sup> to 20* <sup>1</sup>	* <sup>2</sup> to 25* <sup>1</sup>	V
Output Current	I <sub>o</sub>	0 to 1.0							A
Operational Ambient Temperature	T <sub>op</sub>	-30 to 85							°C
Junction Temperature in Operation	T <sub>j</sub>	-20 to 100							°C

\*1: V<sub>IN</sub> (max) and I<sub>o</sub> (max) are restricted by the relationship P<sub>D</sub> (max) = (V<sub>IN</sub> - V<sub>o</sub>) × I<sub>o</sub> .

\*2: Refer to the Dropout Voltage parameter.

2-2-3 Electrical Characteristics(1) (SI-3012KM,SI-3025KM,SI-3033KM)  $T_a = 25^\circ\text{C}$ 

Parameter	Symbol	Ratings									Units
		SI-3012KM( $V_o$ adjustable)			SI-3025KM			SI-3033KM			
		min	typ	max	min	typ	max	min	typ	max	
Input Voltage	$V_{IN}$	2.4 <sup>*1</sup>			<sup>*1</sup>			<sup>*1</sup>			V
Output Voltage	$V_o$ ( $V_{oadj}$ )	(1.24)	(1.28)	(1.32)	2.45	2.5	2.55	3.234	3.300	3.366	V
Output Voltage Settings	Conditions	$V_{IN}=3.3V, I_o=10mA$			$V_{IN}=3.3V, I_o=10mA$			$V_{IN}=5V, I_o=10mA$			
Line Regulation	$\Delta V_{OLINE}$ Conditions			15			15			15	mV
	Conditions	$V_{IN}=3.3$ to $8V, I_o=10mA(V_o=2.5V)$			$V_{IN}=3.3V, I_o=10mA$			$V_{IN}=3.3V, I_o=10mA$			
Load Regulation	$\Delta V_{OLOAD}$ Conditions			40			40			40	mV
	Conditions	$V_{IN}=3.3V, I_o=0$ to $1A(V_o=2.5V)$			$V_{IN}=3.3V, I_o=0$ to $1A$			$V_{IN}=5V, I_o=0$ to $1A$			
Dropout Voltage	$V_{DIF1}$ Conditions			0.4			0.4			0.4	V
	Conditions	$I_o=0.5A(V_o=2.5V)$			$I_o=0.5A$			$I_o=0.5A$			
	$V_{DIF2}$ Conditions			0.6			0.6			0.6	
	Conditions	$I_o=1A(V_o=2.5V)$			$I_o=1A$			$I_o=1A$			
Quiescent Circuit Current	$I_q$			350			350			350	$\mu A$
	Conditions	$V_{IN}=3.3V, I_o=0A, V_C=2V, R2=24k\Omega$			$V_{IN}=3.3V, I_o=0A, V_C=2V$			$V_{IN}=5V, I_o=0A, V_C=2V$			
Circuit Current at Output OFF	$I_q(OFF)$			1			1			1	$\mu A$
	Conditions	$V_{IN}=3.3V, V_C=0V$			$V_{IN}=3.3V, V_C=0V$			$V_{IN}=5V, V_C=0V$			
Temperature Coefficient of Output Voltage	$\frac{\Delta V_o}{\Delta T_a}$		$\pm 0.3$			$\pm 0.3$			$\pm 0.3$		mV/ $^\circ C$
	Conditions	$T_j=0$ to $100^\circ C(V_o=2.5V)$			$T_j=0$ to $100^\circ C$			$T_j=0$ to $100^\circ C$			
Ripple Rejection	$R_{REJ}$		55			55			55		dB
	Conditions	$V_{IN}=3.3V, f=100$ to $120Hz, V_o=2.5V$			$V_{IN}=3.3V, f=100$ to $120Hz$			$V_{IN}=5V, f=100$ to $120Hz$			
Overcurrent Protection Starting Current <sup>*2</sup>	$I_{S1}$	1.1			1.1			1.1			A
	Conditions	$V_{IN}=3.3V$			$V_{IN}=3.3V$			$V_{IN}=5V$			
$V_C$ Terminal	Control Voltage (Output ON) <sup>*3</sup>	$V_{C,IH}$	2.2		2.2			2.2			V
	Control Voltage (Output OFF)	$V_{C,IL}$		0.8		0.8			0.8		
	Control Current (Output ON)	$I_{C,IH}$ Conditions		40		40			40		$\mu A$
	Control Current (Output OFF)	$I_{C,IL}$ Conditions	-5	0		-5	0		-5	0	
		Conditions	$V_C=2V$			$V_C=2V$			$V_C=2V$		
	Conditions	$V_C=0V$			$V_C=0V$			$V_C=0V$			

\*1: Refer to the clause of a difference in input and output voltage.

\*2:  $I_{S1}$  is specified at the 5% drop point of output voltage  $V_o$  on the condition that  $V_{IN}$  = overcurrent protection starting current,  $I_o = 10mA$ .

\*3: Output is OFF when the output control terminal  $V_c$  is open. Each input level is equivalent to LS-TTL level. Therefore, the device can be driven directly by LS-TTLs.

Attention ...

As  $PD=(V_{IN}-V_o)\times I_o$ ,  $V_{IN}(MAX)$  and  $I_o(MAX)$  must be referred to the data of P17, copper area vs power dissipation upon actual applications.

2-2-3 Electrical Characteristics(2) (SI-3010KM,SI-3050KM,SI-3090KM)  $T_a = 25^\circ\text{C}$ 

Parameter	Symbol	Ratings									Units
		SI-3010KM( $V_o$ adjustable)			SI-3050KM			SI-3090KM			
		min	typ	max	min	typ	max	min	typ	max	
Input Voltage	$V_{IN}$	2.4* <sup>1</sup>			* <sup>1</sup>			* <sup>1</sup>			V
Output Voltage Settings	$V_{O,reg}$ ( $V_{adj}$ ) Conditions	(0.98)	(1.00)	(1.02)	4.90	5.00	5.10	8.82	9.00	9.18	V
Line Regulation	$\Delta V_{OLINE}$ Conditions			30			75			54	mV
		$V_{IN}=6$ to $11V$ , $I_o=10mA$ ( $V_o=5V$ )			$V_{IN}=6$ to $11V$ , $I_o=10mA$			$V_{IN}=10$ to $15V$ , $I_o=10mA$			
Load Regulation	$\Delta V_{OLOAD}$ Conditions			75			40			40	mV
		$V_{IN}=7V$ , $I_o=0$ to $1A$ ( $V_o=5V$ )			$V_{IN}=7V$ , $I_o=0$ to $1A$			$V_{IN}=11V$ , $I_o=0$ to $1A$			
Dropout Voltage	$V_{DIF1}$ Conditions			0.3			0.3			0.3	V
		$I_o=0.5A$ ( $V_o=5V$ )			$I_o=0.5A$			$I_o=0.5A$			
	$V_{DIF2}$ Conditions			0.6			0.6			0.6	
		$I_o=1A$ ( $V_o=5V$ )			$I_o=1A$			$I_o=1A$			
Quiescent Circuit Current	$I_q$ Conditions			600			600			600	$\mu A$
		$V_{IN}=7V$ , $I_o=0A$ , $V_C=2V$ , $R2=10k\Omega$			$V_{IN}=7V$ , $I_o=0A$ , $V_C=2V$			$V_{IN}=11V$ , $I_o=0A$ , $V_C=2V$			
Circuit Current at Output OFF	$I_{q(OFF)}$ Conditions			1			1			1	$\mu A$
		$V_{IN}=7V$ , $V_C=0V$			$V_{IN}=7V$ , $V_C=0V$			$V_{IN}=11V$ , $V_C=0V$			
Temperature Coefficient of Output Voltage	$\Delta V_o / \Delta T_a$ Conditions		$\pm 0.5$			$\pm 0.5$			$\pm 1.0$		mV/ $^\circ C$
		$T_j=0$ to $100^\circ C$ ( $V_o=5V$ )			$T_j=0$ to $100^\circ C$			$T_j=0$ to $100^\circ C$			
Ripple Rejection	$R_{REJ}$ Conditions		75			75			68		dB
		$V_{IN}=7V$ , $f=100$ to $120Hz$ , $V_o=5V$			$V_{IN}=7V$ , $f=100$ to $120Hz$			$V_{IN}=11V$ , $f=100$ to $120Hz$			
Overcurrent Protection Starting Current* <sup>2</sup>	$I_{s1}$ Conditions	1.1			1.1			1.1			A
		$V_{IN}=7V$			$V_{IN}=7V$			$V_{IN}=11V$			
V <sub>C</sub> Terminal	Control Voltage (Output ON)* <sup>3</sup> $V_{C,1H}$	2.0			2.0			2.0			V
	Control Voltage (Output OFF) $V_{C,1L}$			0.8			0.8			0.8	
	Control Current (Output ON) $I_{C,1H}$ Conditions			40			40			40	$\mu A$
		$V_C=2V$			$V_C=2V$			$V_C=2V$			
	Control Current (Output OFF) $I_{C,1L}$ Conditions	-5	0		-5	0		-5	0		
	$V_C=0V$			$V_C=0V$			$V_C=0V$				
Input Overvoltage Shutdown Voltage	$V_{OVP}$ Conditions	33			26			30			V
		$I_o=10mA$			$I_o=10mA$			$I_o=10mA$			

\*1: Refer to the clause of a difference in input and output voltage.

\*2:  $I_{s1}$  is specified at the 5% drop point of output voltage  $V_o$  on the condition that  $V_{IN}$  = overcurrent protection starting current,  $I_o = 10mA$ .

\*3: Output is OFF when the output control terminal  $V_c$  is open. Each input level is equivalent to LS-TTL level. Therefore, the device can be driven directly by LS-TTLs.

Attention ...

SI-3010KM,SI-3050KM,SI-3090KM cannot be used in the following applications because the built-in foldback-type overcurrent protection may cause errors during start-up stage;

(1) Constant current load (2) Positive and negative power supply (3) Series-connected power supply (4) Vo adjustment by raising ground voltage

As  $PD=(V_{IN}-V_O)\times I_o$ ,  $V_{IN}(\text{MAX})$  and  $I_o(\text{MAX})$  must be referred to the data of P17, copper area vs power dissipation upon actual applications.

### 2-2-3 Electrical Characteristics(3) (SI-3120KM) $T_a = 25^\circ\text{C}$

Parameter	Symbol	Ratings			Units	
		SI-3120KM				
		min	typ	max		
Input Voltage	$V_{IN}$	*1			V	
Output Voltage	$V_O$ or $(V_{OH})$	11.76	12.00	12.24	V	
Settings	Conditions	$V_{IN}=7V, I_o=10mA$				
Line Regulation	$\frac{\Delta V_{OLINE}}{\Delta V_{IN}}$			72	mV	
Conditions	$V_{IN}=13 \text{ to } 18V, I_o=10mA$					
Load Regulation	$\frac{\Delta V_{LOAD}}{\Delta I_o}$			180	mV	
Conditions	$V_{IN}=14V, I_o=0 \text{ to } 1A$					
Dropout Voltage	$V_{DIF1}$			0.3	V	
	Conditions	$I_o=0.5A$				
	$V_{DIF2}$			0.6		
	Conditions	$I_o=1A$				
Quiescent Circuit Current	$I_q$			600	$\mu A$	
Conditions	$V_{IN}=14V, I_o=0A, V_C=2V,$					
Circuit Current at Output OFF	$I_q(\text{OFF})$			1	$\mu A$	
Conditions	$V_{IN}=7V, V_C=0V$					
Temperature Coefficient of Output Voltage	$\frac{\Delta V_o}{\Delta T_a}$		$\pm 1.5$		$mV/^\circ C$	
	Conditions	$T_j=0 \text{ to } 100^\circ C$				
Ripple Rejection	$R_{REJ}$		66		dB	
Conditions	$V_{IN}=14V, f=100 \text{ to } 120Hz$					
Overcurrent Protection Starting Current	$I_{S1}$	1.1			A	
Conditions	$V_{IN}=14V$					
$V_C$ Terminal	Control Voltage (Output ON)*3	$V_{C,1H}$	2.0		V	
	Control Voltage (Output OFF)	$V_{C,1L}$		0.8		
	Control Current (Output ON)	$I_{C,1H}$			40	$\mu A$
	Conditions	$V_C=2V$				
	Control Current (Output OFF)	$I_{C,1L}$	-5	0		
Conditions	$V_C=0V$					
Input Overvoltage Shutdown Voltage	$V_{OVP}$	33			V	
	Conditions	$I_o=10mA$				

\*1: Refer to the clause of a difference in input and output voltage.

\*2:  $I_{S1}$  is specified at the 5% drop point of output voltage  $V_o$  on the condition that  $V_{IN}$  = overcurrent protection starting current,  $I_o = 10mA$ .

\*3: Output is OFF when the output control terminal  $V_C$  is open. Each input level is equivalent to LS-TTL level. Therefore, the device can be driven directly by LS-TTLs.



Attention ...

SI-3120KM cannot be used in the following applications because the built-in foldback-type overcurrent protection may cause errors during start-up stage;

(1) Constant current load (2) Positive and negative power supply (3) Series-connected power supply (4)  $V_o$  adjustment by raising ground voltage

As  $P_D = (V_{IN} - V_o) \times I_o$ ,  $V_{IN(MAX)}$  and  $I_o(MAX)$  must be referred to the data of P17, copper area vs power dissipation upon actual applications.

*Not Recommended for New Designs:  
SI-3025KM, SI-3050KM*

● **2-3 Circuit Diagram**

2-3-1 Block Diagram

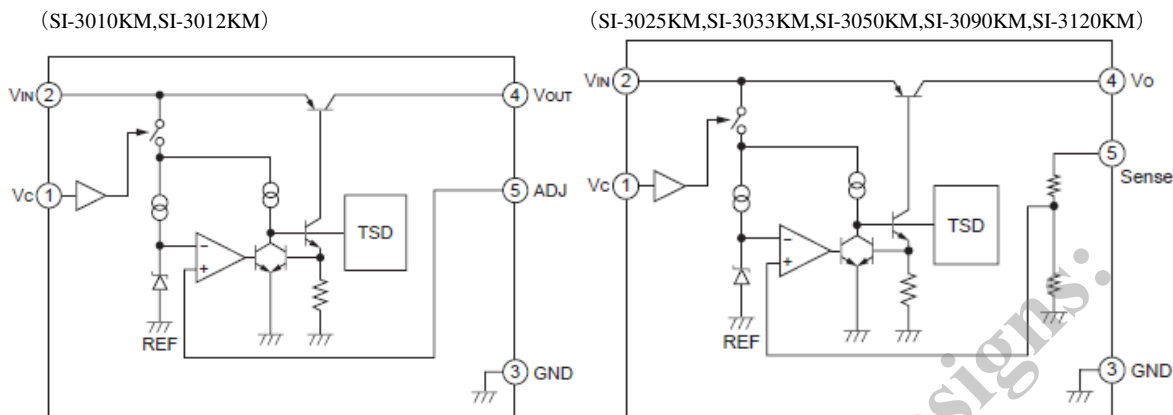

2-3-2 Typical Connection Diagram

(SI-3010KM,SI-3012KM)

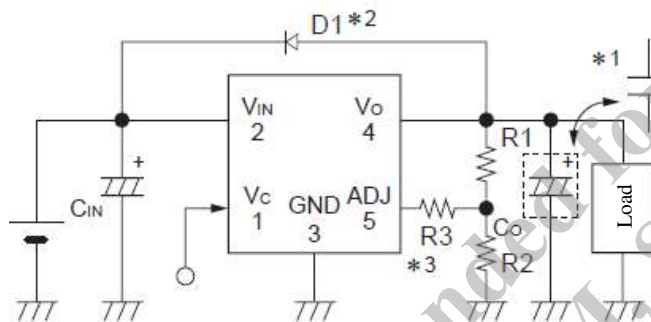

(SI-3025KM,SI-3033KM,SI-3050KM,SI-3090KM,SI-3120KM)

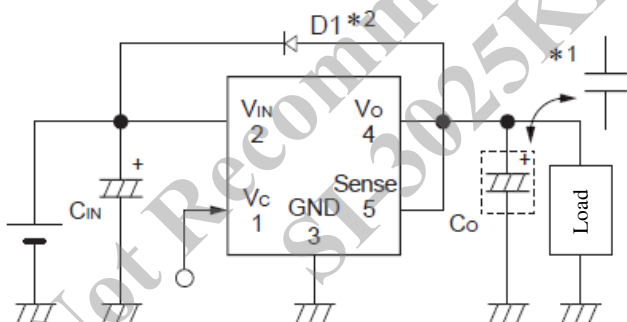

\*1 For SI-3012KM,SI-3025KM,SI-3033KM.

It is the setup to use a ultra-low ESR capacitor such as a ceramics-capacitor for Co with these models. When an electrolytic-capacitor is used for Co, they may oscillate at low-temperature.

\*1 For SI-3010KM,SI-3050KM,SI-3090KM,SI-3120KM.

As for these models,they may oscillate when a ultra-low ESR capacitor such as ceramic-capacitor is used for Co.

\*2: D1: Reverse biased protection diodes

In the case of reverse bias between input and output, this diode will be required.

(Recommended diodes: SJPL-H2 made by Sanken)

It is unnecessary in case of  $V_o \leq 3.3V$ .

R1, R2: resistors for setting output voltages

Output voltages can be adjusted by connecting R1 and R2 as shown in the above figure.

R2: 10k $\Omega$  is recommended.(In case of the SI-3120KM,24k $\Omega$  is recommended.)

$$R1=(V_o-V_{ADJ}) / (V_{ADJ}/R2)$$

\*3: In the case that  $V_o \leq 1.5V$  is set, R3 should be inserted. 10k $\Omega$  is recommended for R3.

Regardless of the setup voltage, R3 is unnecessary in case of the SI-3012KM.

Not Recommended for New Designs:  
SI-3025KM, SI-3050KM

### 3. Operational Description

#### ● 3-1 Voltage Control

In the SI-3000KM series, the driving circuit is controlled by comparing the reference voltage with the ADJ terminal voltage (voltage divided by  $V_o$  detection resistor in fixed output products) to stabilize the output voltage by varying the voltage between the emitter and collector of a main PNP power transistor. The product of voltage between emitter and collector and the output current at this moment is consumed as heat.

#### ● 3-2 Overcurrent Protection

##### 3-2-1 Overcurrent Protection Characterization for SI-3012KM,SI-3025KM,SI-3033KM

The Drooping type overcurrent protection function is provided in these models. In the case of the series regulator, as the output voltage drops subject to the overcurrent protection, the difference of input/output voltages increases to cause significant heating. Special care should be taken for the current limiting type overcurrent protection, since large current flows continuously.

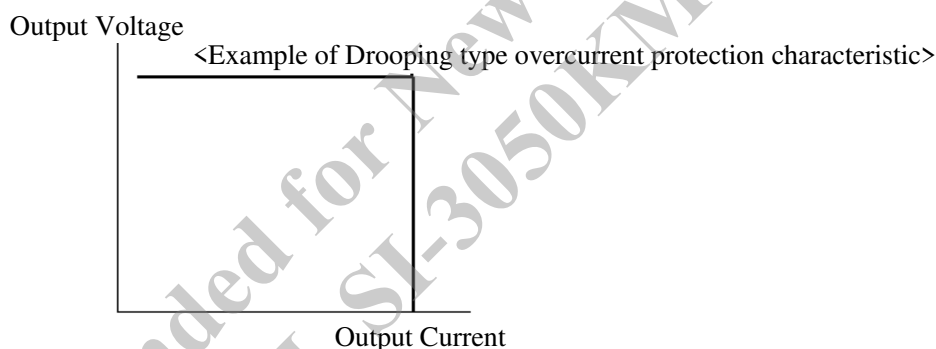

##### 3-2-2 Overcurrent Protection Characterization for SI-3010KM,SI-3050KM,SI-3090KM,SI-3120KM

The foldback type overcurrent protection function is provided in these models. After operation of the overcurrent protection function, if the load resistance decreases and the output voltage drops, the output current of products is squeezed to reduce the increase of loss. However, in the case of the foldback type overcurrent protection function, since current limiting is also made at start-up, the function may not be used for the following applications, as it may cause a start-up error.

- (1) Constant current loads
- (2) Plus/minus power supply
- (3) DC power supply
- (4) Output voltage adjustment by grounding-up

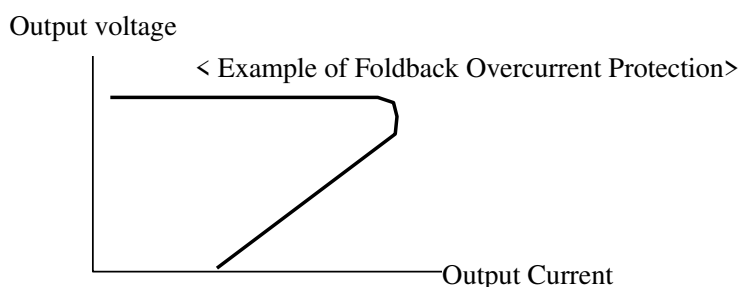

### ● **3-3 Thermal Shutdown**

This IC is provided with the overheat protection circuit which detects the semiconductor junction temperature of the IC to limit the driving current, when the junction temperature exceeds the set value (around 150°C). Since the minimum operating temperature of the overheat protection circuit is 130°C, the thermal design of  $T_j < 125^\circ\text{C}$  is required. Since the overheat protection has no hysteresis, as soon as the overload state is released and  $T_j$  falls below the set temperature, the normal operation is automatically restored. When the overheat protection function is operated in the overload state, the output voltage falls, but at the same time the output current is decreased and in the consequence, overheat protection operation and automatic restoration are repeated in a short interval, resulting eventually in the waveforms of output voltage oscillation.

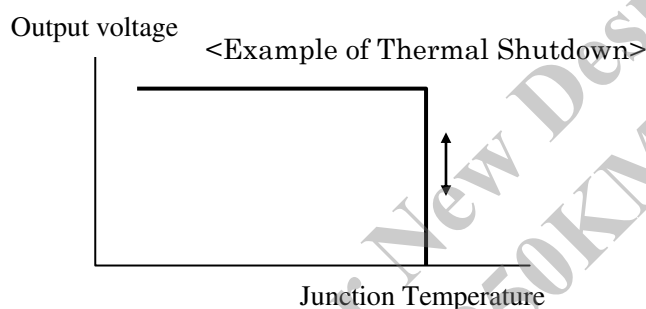

\*Note for thermal shutdown characteristic

This circuit protects the IC against overheat resulting from the instantaneous short circuit, but it should be noted that this function does not assure the operation including reliability in the state that overheat continues due to long time short circuit.

Not Recommended for New Designs:  
SI-3025KM, SI-3030KM

## 4. Cautions

### ● 4-1 External Components

#### 4-1-1 Input Capacitor C<sub>IN</sub>

The input capacitor is required to eliminate noise and stabilize the operation and values of 0.47μF - 22μF are recommended. Any of ceramic capacitors or electrolytic ones may be used for the input capacitor.

#### 4-1-2 Output Capacitor C<sub>O</sub>

C<sub>O</sub> for SI-3010KM,SI-3050KM,SI-3090KM,SI-3120KM

In the output capacitor C<sub>O</sub>, larger capacitance than the recommended value is required for phase compensation. Equivalent series resistance values (ESR) of capacitors are limited, and depending on products, therefore the type of recommended capacitors is limited.

Recommended ESR values for SI-3010KM,SI-3050KM,SI-3090KM,SI-3120KM:  $2\Omega > ESR > 0.2\Omega$

It is recommended to use electrolytic capacitors. When capacitors with ultra-low ESR such as ceramic capacitors, functional polymer capacitors, OS-capacitors etc., are used, phase margin is decreased, possibly causing the oscillation of output voltage. Therefore these capacitors can not be used.

C<sub>O</sub> for SI-3012KM,SI-3025KM,SI-3033KM

Using a ceramics capacitor and a function polymer capacitor, OS-capacitor etc., is recommended.

As for these models, when a big-ESR capacitor such as electrolytic-capacitors was used, phase margin is decreased and possibly causing the oscillation of output voltage. ESR's increase in the low temperature condition. Therefore,

an electrolytic-capacitor can't be recommended because output may oscillate at a low temperature even when the output doesn't oscillate at a room temperature.

#### 4-1-3 Reverse bias protection diode D1

In the case of falling-down of the input voltage, it is recommended to insert a protection diode D1 against the reverse bias between input and output. However, in the case of setting the V<sub>out</sub> < 3.3V or lower, D1 is not required including the case of reverse bias. In order to select a suitable D1, it should be taken into consideration that the diode has adequate forward current withstand voltage against the instantaneous discharge of energy stored in output capacitor C<sub>O</sub>.

The permissible value of the forward current per unit time of diode is specified in I<sub>FSM</sub> (A) and in the case of our diode, it is specified at 50Hz half wave (10ms), but it should be noted that different companies may specify different times. The selection of diode should be made by converting the specified time into the actual discharging time so as to meet the required I<sub>FSM</sub> (A). The discharging time of C<sub>O</sub> is normally shorter than 1ms, but it is recommended to do the conversion with 1ms in consideration of margin.

For conversion into I<sub>FSM</sub>, calculation should be made by using the equations (1) and (2).

$$\left(\frac{I_{FSM}}{\sqrt{2}}\right)^2 * t1 = X \quad \text{--- (1) As for } I_{FSM}, \text{ please refer to the catalog of each company.}$$

t1 = specified time in catalog of each company

$$\text{Converted IFSM} = \sqrt{\frac{2 * X}{t2}} \quad \text{--- (2) } t2: \text{ converted time (discharging time of } C_O)$$

&lt;Graph 1&gt;

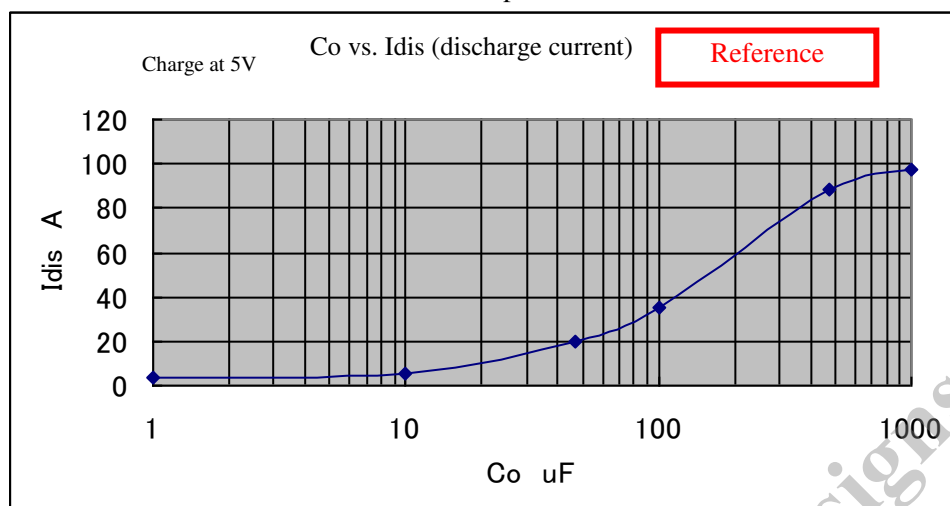

On the assumption of  $C_{out} = 470\mu\text{F}$ ,  $I_{FSM}$  of around 90A or more (in 1ms time period) is required and according to our specifications of diode,  $I_{FSM}$  is specified for 10ms, therefore the diode of 30A has the tolerated dose of 94.8A (in 1ms) to prove that it is usable.

## ● 4-2 Pattern Design Notes

### 4-2-1 Input / Output Capacitor

The input capacitor C1 and the output capacitor C2 should be connected to the IC as close as possible. If the rectifying capacitor for AC rectifier circuit is on the input side, it can be used as an input capacitor. However, if it is not close to the IC, the input capacitor should be connected in addition to the rectifying capacitor.

### 4-2-2 ADJ Terminal (Output Voltage Set-up for SI-3010KM & SI-3012KM)

The ADJ terminal is a feedback detection terminal for controlling the output voltage. The output voltage set-up is achieved by connecting R1 and R2.

SI-3010KM: it should be set in a manner that  $I_{ADJ}$  is around  $100\mu\text{A}$ .

SI-3012KM: it should be set in a manner that  $I_{ADJ}$  is around  $50\mu\text{A}$ .

R1, R2 and output voltage can be obtained by the following equations:

$$I_{ADJ} = V_{ADJ} / R2 \quad \left( \begin{array}{l} *V_{ADJ} = 1.0\text{V} \pm 2\% \text{ (SI-3010KM), } R2 = 10\text{k}\Omega \text{ recommended} \\ *V_{ADJ} = 1.28\text{V} \pm 3\% \text{ (SI-3012KM), } R2 = 24\text{k}\Omega \text{ recommended} \end{array} \right)$$

$$R1 = (V_o - V_{ADJ}) / I_{ADJ} \quad R2 = V_{ADJ} / I_{ADJ}$$

$$V_{out} = R1 \times (V_{ADJ} / R2) + V_{ADJ}$$

## 5. Applications

### ● 5-1 Output ON / OFF Control

The ON/OFF control of output can be made by directly applying voltage to No. 1 Vc terminal. When the Vc terminal is open, the operation is in OFF. The Vc terminal is in OFF below 0.8V and in ON at above 2V.

### ● 5-2 Thermal Design

#### 5-2-1 Calculation of heat dissipation

Heat generation of the surface mounting IC is generally dependent on size, material and copper foil area of the mounted printed circuit board. Full attention should be paid to heat dissipation and adequate margin be taken into consideration at thermal design. In order to enhance the heat dissipation effect, it is recommended to enlarge the copper foil area connected to the stem part on the back side of the product. The copper foil area of the printed circuit board significantly affects the heat dissipation effect.

As the junction temperature  $T_j$  (MAX) is an inherent value, it must be observed strictly. For this purpose, heat sink design (thermal resistance of board) which is appropriate for  $P_d$  (MAX) and  $T_a$  MAX is required. This is graphically shown in the heat derating curve for easy understanding. The heat dissipation design is done in the following procedure.

- 1) The maximum ambient temperature in the set  $T_a$  MAX is obtained.
- 2) The maximum loss  $P_d$ MAX which varies the input/output conditions is obtained.

$$P_d = (V_{IN} - V_{out}) \times I_{out}$$

- 3) The area of copper foil is determined from the intersection point in the heat derating curve below shown.

SI-3000KM series derating curve

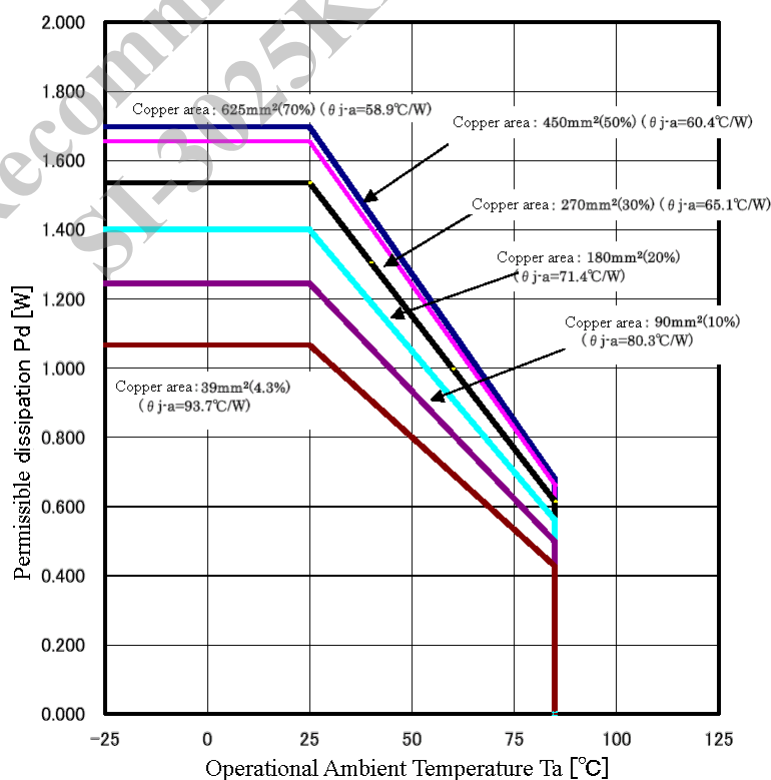



For reference information, the graph of copper foil area vs. thermal resistance between junction temperature and ambient temperature  $\theta_{j-a}$  and the graph of copper foil area vs. permissible dissipation that both are in the single side copper foil board FR - 4 are shown below.

SI-3000KM Copper area vs. Thermal Resistance

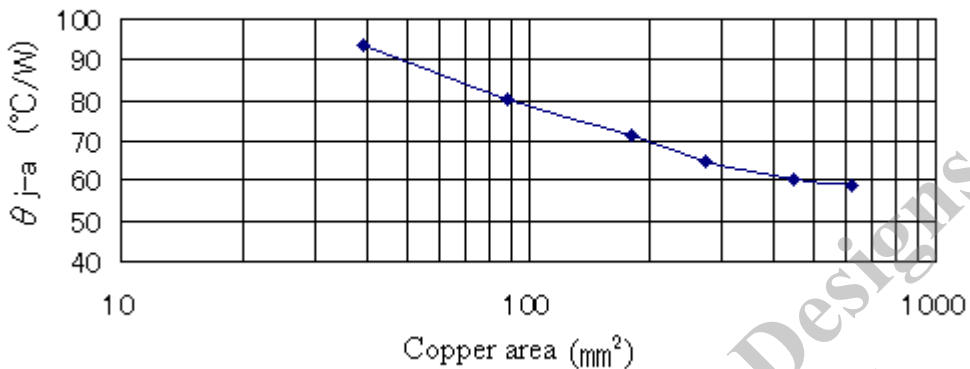

SI-3000KM Copper area vs. Permissible dissipation Pd [W]

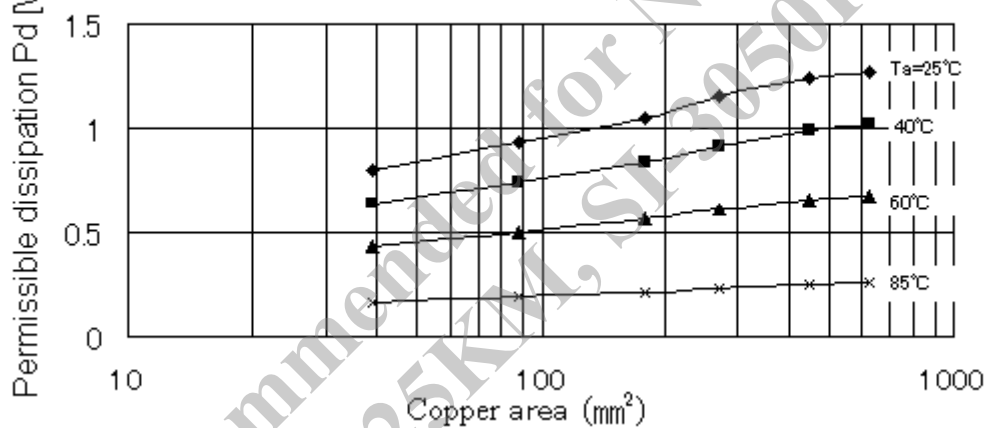

Not Recommended for New Designs:  
SI-3025KM, SI-3050KM

# 6. Typical Characteristics

## 6.1 SI-3012KM

(Ta = 25°C) \*Set Vout = 2.5V (R2 = 24kΩ)

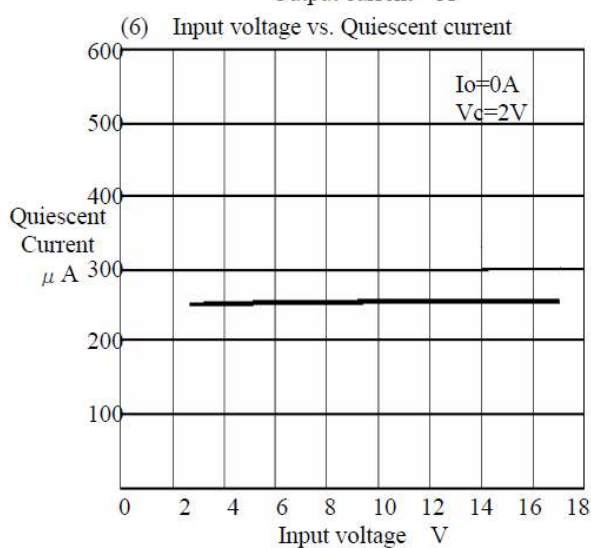
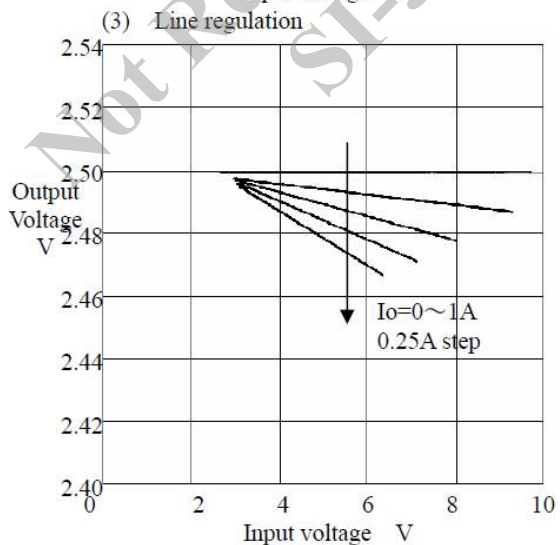
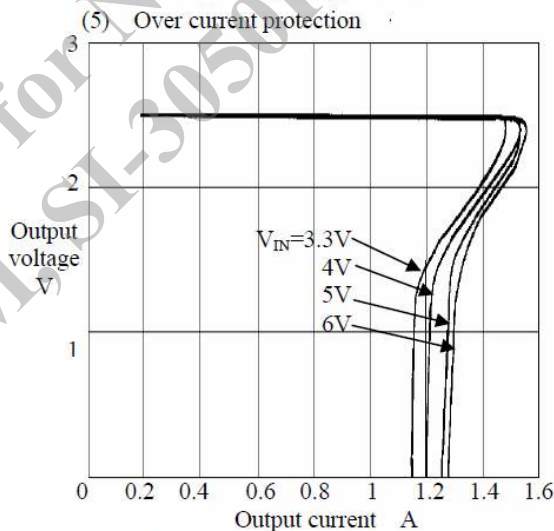
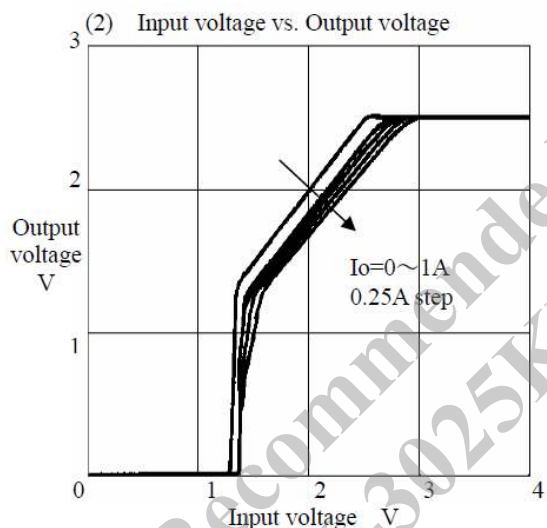
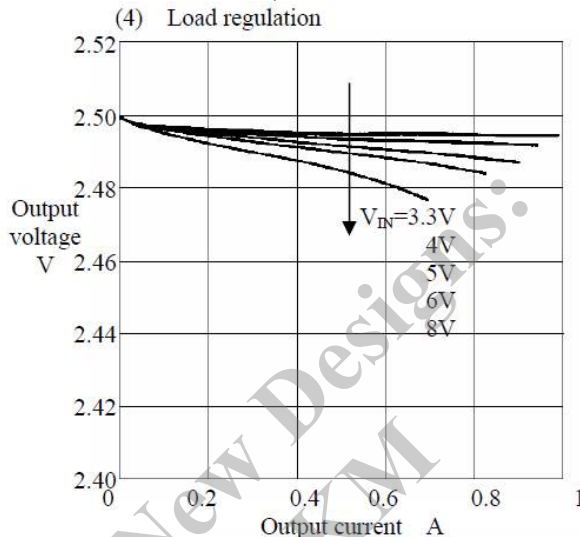
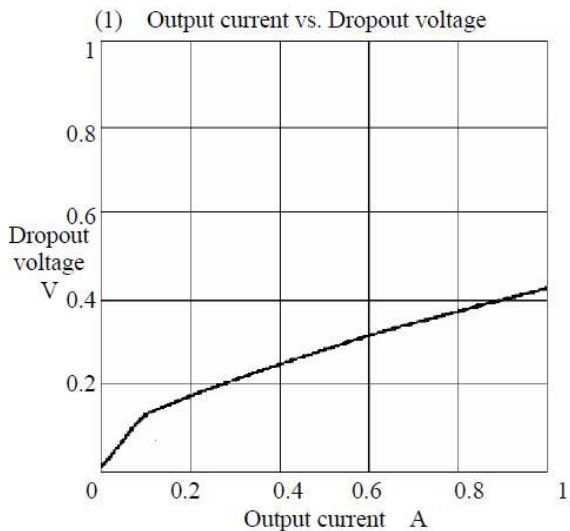

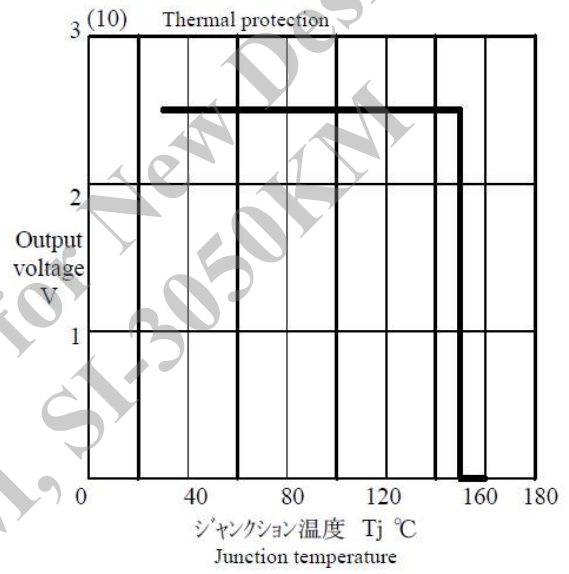
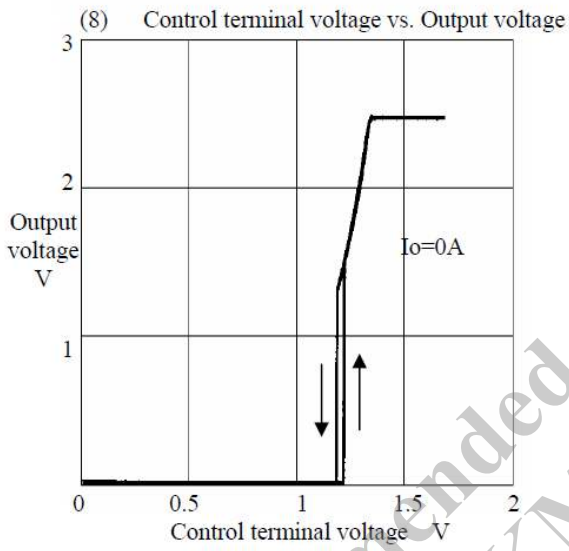
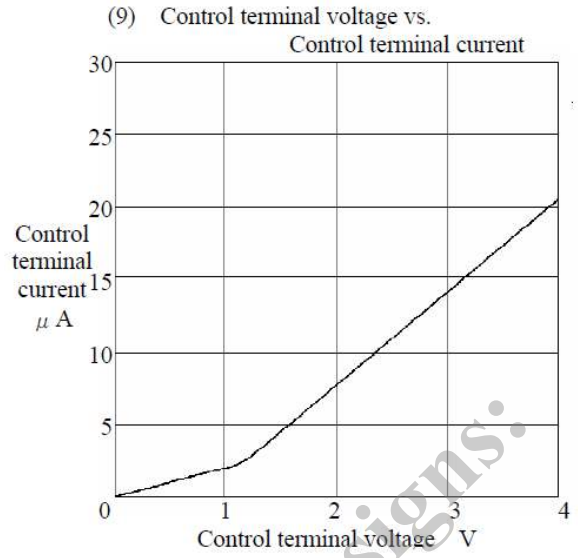
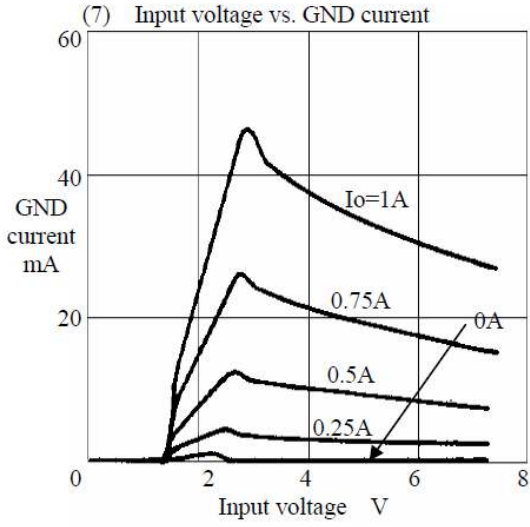

Not Recommended for New Designs:  
SI-3025KM, SI-3050KM

6.1 SI-3010KM

( $T_a = 25^\circ\text{C}$ ) \*Set  $V_{out} = 5\text{V}$  ( $R_2 = 10\text{k}\Omega$ )

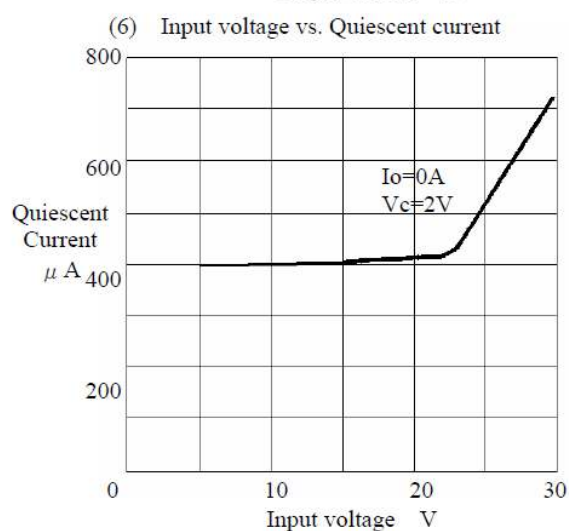
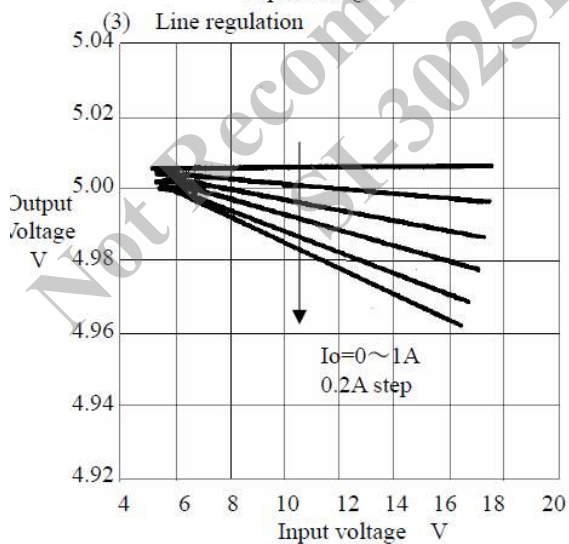
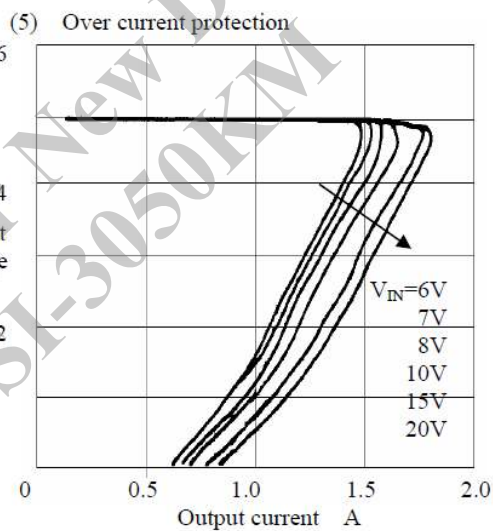
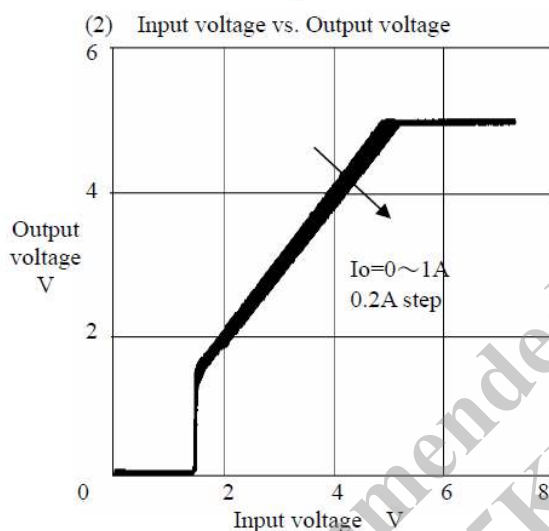
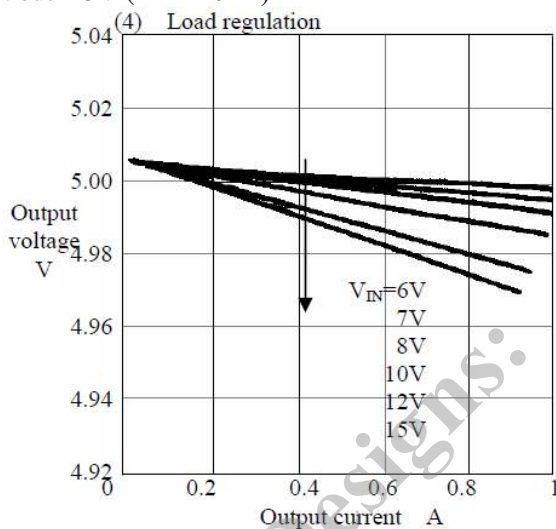
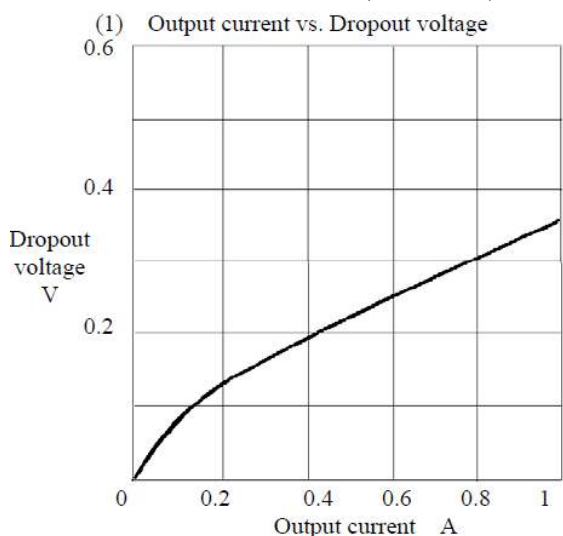

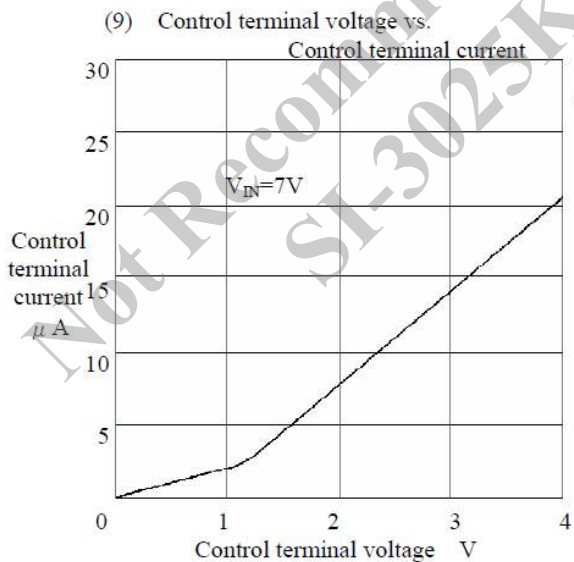
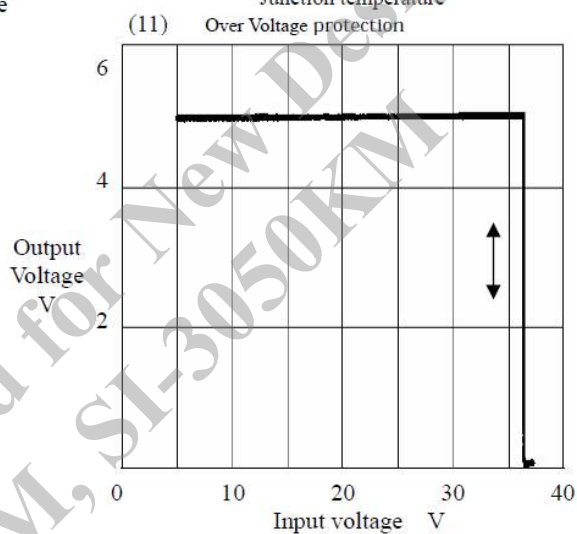
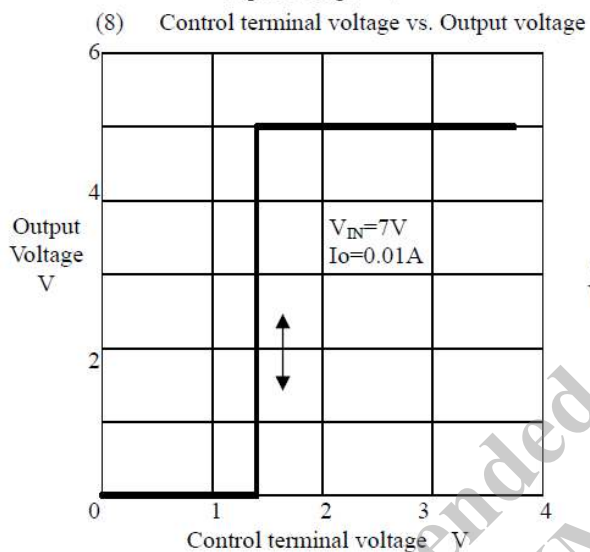
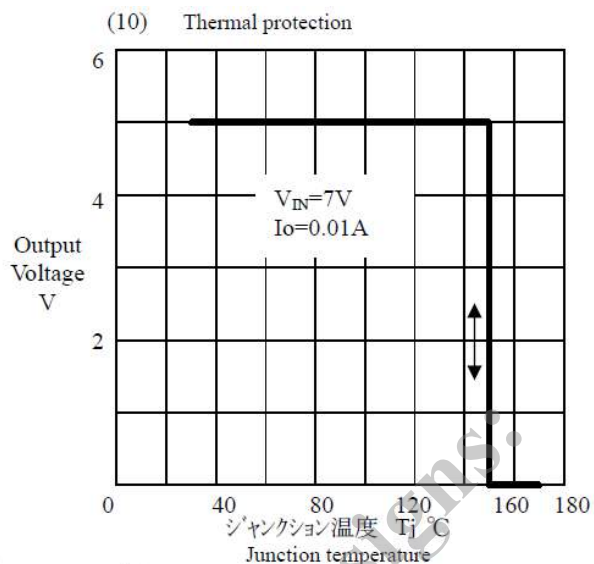
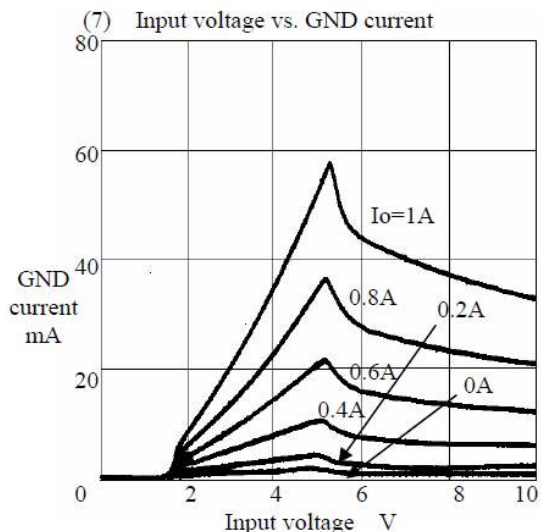

**Notice**

- The contents of this description are subject to change without prior notice for improvement etc. Please make sure that any information to be used is the latest one.
- Any example of operation or circuitry described in this application note is only for reference, and we are not liable to any infringement of industrial property rights, intellectual property rights or any other rights owned by third parties resulting from such examples.
- In the event that you use any product described here in combination with other products, please review the feasibility of combination at your responsibility.
- Although we endeavor to improve the quality and reliability of our product, in the case of semi-conductor components, defects or failures which occur at a certain rate of probability are inevitable. The user should take into adequate consideration the safety design in the equipment or the system in order to prevent accidents causing death or injury, fires, social harms etc..
- Products described here are designed to be used in the general-purpose electronic equipment (home appliances, office equipment, communication terminals, measuring equipment etc.). If used in the equipment or system requiring super-high reliability (transport machinery and its control equipment, traffic signal control equipment, disaster/crime prevention system, various safety apparatus etc.), please consult with our sales office. Please do not use our product for the equipment requiring ultrahigh reliability (aerospace equipment, atomic control, medical equipment for life support etc.) without our written consent.
- The products described here are not of radiation proof type.
- The contents of this brochure shall not be transcribed nor copied without our written consent.

Not Recommended for New Designs:  
SI-3025KM